



# LIGHTING & SAFETY

## D'ECLAIRAGE ET DE SECURITE

PRODUCTS & ACCESSORIES / PRODUITS ET ACCESSOIRES



Driving Lamps | Work Lamps | Warning Lights | Camera Systems  
Utility Lamps | Trailer Lights | Clearance Markers | Safety Accessories

Feux de route | Lampes de travail | Feux d'avertisseur | Systemes de cameras  
Lampes utilitaires | Feux de remorque | Feux d'encombrement | Accessoires de sécurité

# ***“small TEAM doing BIG things”***

**At Uni-Bond, our main focus is providing real value to our customers. This focus is reflected across all areas of our company.**

**In Our Quality:** Uni-Bond’s products are designed and engineered to North American standards. They are certified to meet FMVSS108 DOT, MOT CMVSS108 and SAE standards where applicable. Most manufacturing partners have state of the art quality control equipment, are ISO certified and monitored by Uni-Bond personnel. Always working toward zero defects and exceeding your expectations requires us to take a proactive approach. We strive to prevent problems at the manufacturing stage rather than trying to correct them later.

**In Our Support:** Being proactive with manufacturing processes, practices and the latest technological advancements allows us to stand behind all our products with robust warranties. Our sales representatives, engineers and management are always available to respond to any questions or concerns you might have. Uni-Bond’s pricing is competitive, ensuring the profitability of your business. This, combined with always delivering reliable and trustworthy products is how we have developed so many long-term relationships with our customers.

**In Our Service:** Uni-Bond’s large inventory powers our exceptionally high fill rate. You cannot afford to wait with empty shelves. Our shipping time on orders is usually less than 48 hours. When you call or email, you will get prompt personal response. Our customer service representatives are knowledgeable, attentive and available. No answering machines or answering service.

**In Our Responsibilities:** We are constantly working to improve safety and provide our employees with better conditions and a more secure work place. We regularly review our product, packaging and office procedures to reduce our environmental impact.

**IT ALL ADDS UP TO REAL VALUE.**



## LED DRIVING LAMPS

|                               |  |
|-------------------------------|--|
| LED Headlamps                 |  |
| LED Auxiliary High Beam Lamps |  |

## LED WORK LAMPS

|                                 |  |
|---------------------------------|--|
| ULTRA Series                    |  |
| ULTRA NXT Series                |  |
| C.O.B Series                    |  |
| Standard Series                 |  |
| Super Wide Series               |  |
| Surface Mount Series            |  |
| ECON Series                     |  |
| Low Profile Series              |  |
| Remote Control LED Search Lamps |  |
| Sealed Beam Series - PAR36      |  |
| Battery Operated LED Lamps      |  |
| LED Specialty Lamps             |  |

## LED LIGHT BARS

|                                       |  |
|---------------------------------------|--|
| ULTRA Performance Double Row Straight |  |
| ULTRA Performance Double Row Curved   |  |
| ULTRA NXT Single Row Straight         |  |
| ULTRA NXT Single Row Curved           |  |
| ULTRA NXT Double Row                  |  |
| ULTRA NXT Combo Bar                   |  |
| SCORCH Double Row Straight            |  |
| SCORCH Double Row Curved              |  |

## LED LAMP KITS

|                    |  |
|--------------------|--|
| LED Dual Lamp Kits |  |
| LED Work Lamp Kits |  |

## LED WARNING LIGHT BARS

|                                 |  |
|---------------------------------|--|
| 9.75" Low Profile - Amber       |  |
| 10.5" Standard - Amber          |  |
| 15" Low Profile - Amber         |  |
| 16" Low Profile - Amber         |  |
| 16.5" Standard - Amber          |  |
| 23" Low Profile - Amber         |  |
| 24" Low Profile - Amber         |  |
| 45" Low Profile - Amber         |  |
| 11" Standard - Dual Colour      |  |
| 15" Standard - Dual Colour      |  |
| Over 17" Standard - Dual Colour |  |
| Over 16" - Split Colour         |  |

## LED WARNING LIGHT STICK & ARROW SET

|                          |  |
|--------------------------|--|
| LED Warning Light Sticks |  |
| LED Warning Light Arrows |  |

## LED WARNING BEACONS

|                         |  |
|-------------------------|--|
| High Durability Beacons |  |
| Medium Profile          |  |
| Short Profile           |  |

## FEUX DE ROUTE DEL

|                               |         |
|-------------------------------|---------|
| Phares à DEL                  | 12 - 13 |
| Feu de route auxiliaire à DEL | 14 - 18 |

## LAMPES DE TRAVAIL À DEL

|  |         |
|--|---------|
| Série ULTRA  | 19 - 25 |
| Série ULTRA NXT  | 26      |
| Série C.O.B  | 27      |
| Série Standard   | 28 - 33 |
| Série Super large                                      | 34 - 35 |
| Série Montage en surface                               | 36      |
| Série ECON   | 37 - 39 |
| Série Profile bas                                      | 40      |
| Télécommande pour projecteurs à DEL                    | 41      |
| Série faisceau large genre phares scellé à DEL - PAR36 | 42 - 43 |
| Lampes DEL alimentées par piles                        | 44 - 45 |
| Lampes spécialisées DEL                                | 46 - 47 |

## BARRES LUMINEUX À DEL

|   |    |
|---|----|
| Rangée double droite ULTRA Performance  | 48 |
| Rangée double courbée ULTRA Performance | 49 |
| Rangée single droite ULTRA NXT          | 50 |
| Rangée single courbée ULTRA NXT         | 51 |
| Rangée double ULTRA NXT                 | 52 |
| Barre combo ULTRA NXT                   | 53 |
| Rangée double droite SCORCH             | 54 |
| Rangée double courbée SCORCH            | 55 |

## KIT DE LAMPES DEL

|   |    |
|---|----|
| Rangée double droite ULTRA Performance  | 56 |
| Rangée double courbée ULTRA Performance | 57 |

## BARRE DE FEUX D'AVERTISSEUR DEL

|                                       |         |
|---------------------------------------|---------|
| Profile bas 9.75" - ambre             | 58 - 59 |
| Standard 10.5" - ambre                | 60      |
| Profile bas 15" - ambre               | 61      |
| Profile bas 16" - ambre               | 62      |
| Standard 16.5" - ambre                | 63      |
| Profile bas 23" - ambre               | 64      |
| Profile bas 24" - ambre               | 65      |
| Profile bas 45" - ambre               | 66      |
| Standard 11" - double couleur         | 67      |
| Standard 15" - double couleur         | 68      |
| Standard plus de 17" - double couleur | 69      |
| Plus de 16" - couleur divisée         | 70      |

## AVERTISSEUR LUMINEUX DEL - BARRE ET FLÈCHES

|                                       |         |
|---------------------------------------|---------|
| Barre lumineuse d'avertissement DEL   | 71 - 72 |
| Flèches lumineuse d'avertissement DEL | 73      |

## FEUX DE BALISE D'AVERTISSEUR DEL

|                          |         |
|--------------------------|---------|
| Balises haute durabilité | 74 - 75 |
| Profil moyen             | 76 - 79 |
| Profil court             | 80      |

## LED WARNING BEACONS

|                  |  |
|------------------|--|
| Dual Colour      |  |
| Low Profile      |  |
| Battery Operated |  |

## SURFACE MOUNT LED DIRECTIONALS

|                   |  |
|-------------------|--|
| Dual Colour       |  |
| Super Low Profile |  |
| Low Profile       |  |

## STROBE LIGHTS

|                       |  |
|-----------------------|--|
| Medium Profile        |  |
| 6" Oval               |  |
| 4" Round              |  |
| Battery Operated      |  |
| Mini LED Strobe Heads |  |

## LED SAFETY WHIPS

|             |  |
|-------------|--|
| EW20 Series |  |
| EW30 Series |  |
| EW60 Series |  |

## UTILITY / DOME LAMPS

|                   |  |
|-------------------|--|
| Interior Lamps    |  |
| Outdoor Lamps     |  |
| Traditional Lamps |  |
| LED Light Strips  |  |

## STOP / TURN / TAIL / BACKUP LAMPS

|                               |  |
|-------------------------------|--|
| 6" Oval LED Lamps             |  |
| Specialty 6" Oval Lamps       |  |
| Mid Turn Signal Lamps         |  |
| 4" Round LED Lamps            |  |
| Specialty 4" Round Lamps      |  |
| 6" x 4" Rectangular LED Lamps |  |
| 7" x 6" Combination Lamps     |  |
| Slim Line LED Light Bars      |  |
| LED Tailgate Lights           |  |
| 7" Round LED Lamps            |  |

## TRAILER & UTILITY TRAILER LAMPS

|                              |  |
|------------------------------|--|
| Lamps for Vehicles under 80" |  |
| Lamps for Vehicles over 80"  |  |

## FENDER MOUNT LAMPS

|                               |  |
|-------------------------------|--|
| Low Profile Clearance Marker  |  |
| Round (Stop/Turn/Tail) Lamps  |  |
| Square (Stop/Turn/Tail) Lamps |  |

## CLEARANCE MARKER LAMPS

|                               |  |
|-------------------------------|--|
| 3/4" Round LED Lamps          |  |
| Decorative Chrome Bezel Lamps |  |
| Rectangular Lamps             |  |

## FEUX DE BALISE D'AVERTISSEUR DEL

|                      |         |
|----------------------|---------|
| Double couleur       | 81 - 82 |
| Profil bas           | 83      |
| Alimentées par piles | 84      |

## DIRECTIONNELS DEL À MONTAGE EN SURFACE

|                  |         |
|------------------|---------|
| Double couleur   | 85 - 86 |
| Profil bas super | 87 - 88 |
| Profil bas       | 89 - 90 |

## LAMPES STROBOSCOPIQUES

|                                |    |
|--------------------------------|----|
| Profil moyen                   | 91 |
| Ovale 6"                       | 92 |
| Rond 4"                        | 93 |
| Alimentées par piles           | 94 |
| Mini têtes stroboscopiques DEL | 95 |

## FOUET DE SÉCURITÉ À DEL

|            |         |
|------------|---------|
| Série EW20 | 96      |
| Série EW30 | 97      |
| Série EW60 | 98 - 99 |

## LAMPES STROBOSCOPIQUES

|                        |           |
|------------------------|-----------|
| Lampes d'intérieur     | 100 - 102 |
| Lampes d'extérieur     | 103 - 104 |
| Lampes traditionnelles | 105 - 107 |
| Bandes lumineuses DEL  | 108 - 109 |

## FEUX DE CHANGEMENT DE DIRECTION / ARRÊT / ARRIÈRE / RECUL

|                                  |           |
|----------------------------------|-----------|
| Lampes ovale 6" DEL              | 110 - 116 |
| Lampes ovale spécialité 6" DEL   | 117       |
| Lampes de clignotants moyens     | 118       |
| Lampes ronde 4" DEL              | 119 - 124 |
| Lampes ronde spécialité 4" DEL   | 125       |
| Lampes rectangulaire 6" x 4" DEL | 126       |
| Lampes combinaison 7" x 6" DEL   | 126       |
| Barres lumineuses DEL minces     | 127       |
| Feux de hayon à DEL              | 128       |
| Lampes ronde 7" DEL              | 128       |

## FEUX DE REMORQUE ET REMORQUE UTILITAIRE

|                                       |           |
|---------------------------------------|-----------|
| Lampes pour véhicules de moins de 80" | 129 - 130 |
| Lampes pour véhicules de plus de 80"  | 131 - 132 |

## FEUX A MONTAGE SUR GABARIT

|  |     |
|--|-----|
| Feux d'encombrement et de position profil bas        | 133 |
| Feux ronds (changement de direction/arrêt/arrière)   | 134 |
| Feux carrées (changement de direction/arrêt/arrière) | 135 |

## FEUX D'ENCOMBREMENT ET DE POSITION

|                                      |     |
|--------------------------------------|-----|
| Lampes DEL rondes de 3/4"            | 136 |
| Lampes décoratives à lunette chromée | 137 |
| Lampes rectangulaires                | 138 |

## CLEARANCE MARKER LAMPS

|                            |
|----------------------------|
| 4" Bullseye Lamps          |
| 2" Rectangular Lamps       |
| 4" Rectangular Lamps       |
| Specialty Marker Lamps     |
| 2" Round Lamps             |
| 2.5" Round Lamps           |
| Beehive Lamps              |
| Lightbar Clearance Markers |

## LICENSE LAMPS

|                            |
|----------------------------|
| License Plate Holder       |
| LED License Lamps          |
| Incandescent License Lamps |

## TRAILER MODULES

|                                  |
|----------------------------------|
| Two Hole w/ LED Lamps            |
| Two Hole w/ Incandescent Lamps   |
| Three Hole w/ LED Lamps          |
| Three Hole w/ Incandescent Lamps |

## TOW LIGHT KITS

|  |
|--|
| Heavy Duty LED - Magnetic Mount          |
| Heavy Duty Incandescent - Magnetic Mount |

## BULBS

|                           |
|---------------------------|
| Replacement Mini Bulbs    |
| Replacement Halogen Bulbs |

## BACK-UP ALARMS

|       |
|-------|
| 97dB  |
| 107dB |
| 112dB |

## MIRRORS

|                    |
|--------------------|
| Convex Mirrors     |
| Mirror Accessories |
| West Coast Mirrors |

## ACCESSORIES

|                           |
|---------------------------|
| Conspicuity Tape - Rolls  |
| Conspicuity Tape - Strips |
| Rectangular Reflectors    |
| Round Reflectors          |
| Oval Reflectors           |
| Branch Deflectors         |
| 2" x 1" Base Mounts       |
| 4" x 1" Base Mounts       |
| 3/4" Round Chrome Bezels  |
| 2" Round Chrome Bezels    |
| 2.5" Round Chrome Bezels  |
| 6" Oval Chrome Bezels     |
| 4" Round Chrome Bezels    |

## FEUX D'ENCOMBREMENT ET DE POSITION

|  |           |
|--|-----------|
| Lampes bullseye de 4"                          | 139       |
| Lampes rectangulaires de 2"                    | 140 - 141 |
| Lampes rectangulaires de 4"                    | 142       |
| Feux d'encombrement et de position spécialisés | 143       |
| Lampes rondes de 2"                            | 144 - 149 |
| Lampes rondes de 2.5"                          | 150 - 155 |
| Lampes de ruche                                | 156 - 157 |
| Marqueurs de dégagement de barre lumineuse     | 158       |

## FEUX DE PLAQUE

|                              |           |
|------------------------------|-----------|
| Support de plaque            | 159       |
| Feux de plaque DEL           | 159 - 161 |
| Feux de plaque incandescence | 159 - 161 |

## MODULES DE REMORQUE

|                                       |           |
|---------------------------------------|-----------|
| Deux trous avec lampes DEL            | 162 - 164 |
| Deux trous avec lampes incandescence  | 165       |
| Trois trous avec lampes DEL           | 166       |
| Trois trous avec lampes incandescence | 166       |

## FEUX DE SÉCURITÉ

|  |     |
|--|-----|
| Support magnétique - Robuste DEL           | 167 |
| Support magnétique - Robuste incandescence | 168 |

## AMPOULES

|                                   |     |
|-----------------------------------|-----|
| Mini ampoules de remplacement     | 169 |
| Halogène ampoules de remplacement | 170 |

## AVERTISSEURS DE REcul

|       |     |
|-------|-----|
| 97dB  | 171 |
| 107dB | 171 |
| 112dB | 171 |

## MIROIRS

|                          |           |
|--------------------------|-----------|
| Miroirs convexes         | 172 - 173 |
| Accessoires pour miroirs | 173       |
| Miroirs West Coast       | 174       |

## ACCESSOIRES

|                                   |     |
|-----------------------------------|-----|
| Bande de visibilité - rouleau     | 175 |
| Bande de visibilité - bandes      | 175 |
| Réflecteurs rectangulaires        | 176 |
| Réflecteurs rondes                | 176 |
| Réflecteurs ovale                 | 176 |
| Support de déflecteurs            | 177 |
| Montures de base 2" x 1"          | 177 |
| Montures de base 4" x 1"          | 177 |
| Lunettes chromées pour 3/4" ronde | 178 |
| Lunettes chromées pour 2" ronde   | 178 |
| Lunettes chromées pour 2.5" ronde | 178 |
| Lunettes chromées pour 6" ovale   | 178 |
| Lunettes chromées pour 4" ronde   | 178 |

## ACCESSORIES

|                                    |
|------------------------------------|
| 2" Round ABS Flange                |
| 2.5" Round ABS Flange              |
| 6" Oval ABS Flange                 |
| 6" x 4" Stainless Steel Flange     |
| 4" Round Flange                    |
| 2" x 1" Grommets                   |
| 3/4" Round Grommets                |
| 2" Round Grommets                  |
| 2.5" Round Grommets                |
| 6" Oval Grommets                   |
| 4" Round Grommets                  |
| 6" x 4" Grommets                   |
| Mounting Brackets for 2" Round     |
| Mounting Brackets for 2.5" Round   |
| Mounting Brackets for 6" Oval      |
| Mounting Brackets for 4" Round     |
| Mounting Brackets for 6" x 4"      |
| Single Contact Pigtails            |
| Double Contact Pigtails            |
| Trailer Wire Harness               |
| Trunk Wire Harness                 |
| Wire Harnesses for Trailer Modules |
| Work Lamp Harness                  |
| Snow Plow Plug & Go Harness        |
| Work Lamp Mounting Brackets        |
| Fuse & Switch Kits                 |
| Camera Systems                     |
| Safety Products                    |
| Other Accessories                  |

## ACCESSOIRES

|   |           |
|---|-----------|
| Brides ABS pour 2" ronde                  | 179       |
| Brides ABS pour 2.5" ronde                | 179       |
| Brides ABS pour 6" ovale                  | 179       |
| Brides acier inoxydable pour 6" x 4"      | 179       |
| Brides pour 4" ronde                      | 179       |
| Bagues de montage pour 2" x 1"            | 180       |
| Bagues de montage pour 3/4" ronde         | 180       |
| Bagues de montage pour 2" ronde           | 180       |
| Bagues de montage pour 2.5" ronde         | 180       |
| Bagues de montage pour 6" ovale           | 180       |
| Bagues de montage pour 4" ronde           | 180       |
| Bagues de montage pour 6" x 4"            | 180       |
| Supports de montage pour 2" ronde         | 180       |
| Supports de montage pour 2.5" ronde       | 180       |
| Supports de montage pour 6" ovale         | 180       |
| Supports de montage pour 4" ronde         | 180       |
| Supports de montage pour 6" x 4"          | 180       |
| Spirales de raccord à single contact      | 181       |
| Spirales de raccord à double contact      | 182       |
| Fils couples de remorques                 | 183       |
| Fils couples de coffre                    | 183       |
| Fils couples pour modules de remorque     | 183       |
| Harnais de lampe de travail               | 184       |
| Harnais Plug & Go pour chasse-neige       | 185       |
| Supports de montage pour lampe de travail | 186       |
| Kits de fusibles et d'interrupteurs       | 187       |
| Systèmes de caméras                       | 188 - 189 |
| Produits de sécurité                      | 190       |
| Autres accessoires                        | 191       |

## SEALED BEAM LAMPS

|                          |
|--------------------------|
| PAR36 & PAR46 Work Lamps |
|--------------------------|

## LAMPES À PHARE SCELLÉ

|                                  |     |
|----------------------------------|-----|
| Lampes de travail PAR36 et PAR46 | 192 |
|----------------------------------|-----|

## PROGRAMS & DISPLAYS

|                           |
|---------------------------|
| Work Lamp POP Displays    |
| Snow Plow Sign Board Kits |
| Display Programs          |

## LAMPES STROBOSCOPIQUES

|   |           |
|---|-----------|
| Présentoirs POP pour lampes de travail              | 193       |
| Kits de panneaux de signalisation pour chasse-neige | 194 - 195 |
| Programmes d'affichage sample                       | 196       |

## TECHNICAL INFORMATION

|                                    |
|------------------------------------|
| Trailer Lamp Location Requirements |
| SAE Lighting Identification Codes  |
| IP Rating                          |

## FOUET DE SÉCURITÉ À DEL

|  |           |
|--|-----------|
| Exigences relatives à l'emplacement des feux de remorque | 197 - 198 |
| Code d'identification SAE de lampes                      | 199       |
| Indice IP  | 200       |

## PART NUMBER INDEX

|       |
|-------|
| Index |
|-------|

## INDEX DES NUMÉROS DE PIÈCES

|       |           |
|-------|-----------|
| Index | 201 - 204 |
|-------|-----------|

| LED Driving Lamps   |   | LED Driving Lamps |
|---|---|-------------------|
|  |  |                   |
| LED Headlamps<br>Pg. 12 - 13  | LED Auxiliary High Beam Lamps<br>Pg. 14 - 18                                      |                   |

| LED Work Lamps  |   |   |   |  | LED Work Lamps  |   |
|---|---|---|---|--|---|---|
|  |  |  |  |  |  |  |
| ULTRA Series<br>Pg. 19 - 25   | ULTRA NXT Series<br>Pg. 26  | C.O.B Series<br>Pg. 27  | Standard Series<br>Pg. 28 - 33  | Super Wide Series<br>Pg. 34 - 35   | Surface Mount Series<br>Pg. 36  | ECON Series<br>Pg. 37 - 39  |
|  |  |  |  |  |   |   |
| Low Profile Series<br>Pg. 40  | Remote Control LED Search Lamps<br>Pg. 41   | Sealed Beam Series - PAR36<br>Pg. 42 - 43   | Battery Operated LED Lamps<br>Pg. 44 - 45   | LED Specialty Lamps<br>Pg. 46 - 47   |   |   |

| LED Light Bars  |   | LED Light Bars   |   |
|---|---|--|---|
|  |  |  |  |
| ULTRA Performance Double Row Straight<br>Pg. 48                                     | ULTRA Performance Double Row Curved<br>Pg. 49                                       | ULTRA NXT Single Row Straight<br>Pg. 50  | ULTRA NXT Single Row Curved<br>Pg. 51   |
|  |  |  |  |
| ULTRA NXT Double Row<br>Pg. 52  | ULTRA NXT Combo Bar<br>Pg. 53   | SCORCH Double Row Straight<br>Pg. 54   | SCORCH Double Row Curved<br>Pg. 55  |

| LED Lamp Kits   |   | LED Lamp Kits |
|---|---|---------------|
|  |  |               |
| LED Dual Lamp Kits<br>Pg. 56  | LED Work Lamp Kits<br>Pg. 57  |               |



**LED Warning Light Bars**

**LED Warning Light Bars**

|   |   |  |   |
|---|---|--|---|
|  |  |  |  |
| 9.75" Low Profile - Amber   | 10.5" Standard - Amber  | 15" Low Profile - Amber  | 16" Low Profile - Amber   |
| Pg. 58 - 59   | Pg. 60  | Pg. 61   | Pg. 62  |
|  |  |  |  |
| 16.5" Standard - Amber  | 23" Low Profile - Amber   | 24" Low Profile - Amber  | 45" Low Profile - Amber   |
| Pg. 63  | Pg. 64  | Pg. 65   | Pg. 66  |
|  |  |  |  |
| 11" Standard - Dual Colour  | 15" Standard - Dual Colour  | Over 17" Standard - Dual Colour  | Over 16" - Split Colour   |
| Pg. 67  | Pg. 68  | Pg. 69   | Pg. 70  |

**LED Warning Light Stick & Arrow Set**

**LED Warning Light Stick & Arrow Set**

|   |  |  |
|---|--|--|
|  |  |  |
| LED Warning Light Sticks  | LED Warning Light Arrows   |  |
| Pg. 71 - 72   | Pg. 73   |  |



**LED Warning Beacons**

**LED Warning Beacons**



|   |   |   |   |  |   |  |
|---|---|---|---|--|---|--|
|  |  |  |  |  |  |  |
| High Durability Beacons   | Medium Profile  | Short Profile   | Dual Colour   | Low Profile  | Battery Operated  |  |
| Pg. 74 - 75   | Pg. 76 - 79   | Pg. 80  | Pg. 81 - 82   | Pg. 83   | Pg. 84  |  |





**Surface Mount LED Directionals**









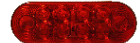

**Surface Mount LED Directionals**

|   |   |   |  |
|---|---|---|--|
|  |  |  |  |
| Dual Colour   | Super Low Profile   | Low Profile   |  |
| Pg. 85 - 86   | Pg. 87 - 88   | Pg. 89 - 90   |  |

| Strobe Lights   |   |   |   |  | Strobe Lights |
|---|---|---|---|--|---------------|
|  |  |  |  |  |               |
| Medium Profile  | 6" Oval   | 4" Round  | 6.5" Battery Operated   | Mini LED Strobe Heads  |               |
| Pg. 91  | Pg. 92  | Pg. 93  | Pg. 94  | Pg. 95   |               |

| LED Safety Whips  |   |   | LED Safety Whips |
|---|---|---|------------------|
|  |  |  |                  |
| EW20 Series   | EW30 Series   | EW60 Series   |                  |
| Pg. 96  | Pg. 97  | Pg. 98 - 99   |                  |

| Utility / Dome Lamps  |   |   |   | Utility / Dome Lamps |
|---|---|---|---|----------------------|
|  |  |  |  |                      |
| Interior Lamps  | Outdoor Lamps   | Traditional Lamps   | LED Light Strips  |                      |
| Pg. 100 - 102   | Pg. 103 - 104   | Pg. 105 - 107   | Pg. 108 - 109   |                      |

| Stop/Turn/Tail/Back Up Lamps  |   |   |  |  | Stop/Turn/Tail/Back Up Lamps  |   |
|---|---|---|--|--|---|---|
|  |  |  |   |  |  |  |
| 6" Oval LED Lamps   | Specialty 6" Oval Lamps   | Mid Turn Signal Lamps   | 4" Round LED Lamps   | Specialty 4" Round Lamps   | LED (4" x 6") Lamps   | Combination Lamps   |
| Pg. 110 - 116   | Pg. 117   | Pg. 118   | Pg. 119 - 124  | Pg. 125  | Pg. 126   | Pg. 126   |
|  |  |   |  |  |   |   |
| Slim Line LED Light Bars  | LED Tailgate Lights   |   | 7" Round LED Lamps   |  |   |   |
| Pg. 127   | Pg. 128   |   | Pg. 128  |  |   |   |

**Trailer & Utility Trailer Lamps**

**Trailer & Utility Trailer Lamps**

|   |   |  |
|---|---|--|
|  |  |  |
| LED for Vehicles under 80"  | LED for Vehicles over 80"   |  |
| Pg. 129 - 130   | Pg. 131 - 132   |  |

**Fender Mount Lamps**

**Fender Mount Lamps**

|   |   |   |  |
|---|---|---|--|
|  |  |  |  |
| Low Profile Clearance Marker  | Round Signal Lamps  | Square Signal Lamps   |  |
| Pg. 133   | Pg. 134   | Pg. 135   |  |

**Clearance Marker Lamps**





**Clearance Marker Lamps**

|   |   |   |  |  |   |   |
|---|---|---|--|--|---|---|
|    |    |    |     |  |  |  |
| 3/4" LED Lamps  | Decorative Chrome Bezel Lamps   | Rectangular Lamps   | Bullseye (2" x 4") Lamps   | 2" Rectangular Lamps   | 4" Rectangular Lamps  | Specialty Marker Lamps  |
| Pg. 136   | Pg. 137   | Pg. 138   | Pg. 139  | Pg. 140 - 141  | Pg. 142   | Pg. 143   |
|  |  |  |  |  |   |   |
| 2" Round Lamps  | 2.5" Round Lamps  | Beehive Lamps   | Lightbar Clearance   |  |   |   |
| Pg. 144 - 149   | Pg. 150 - 155   | Pg. 156 - 157   | Pg. 158  |  |   |   |

**License Lamps**

**License Lamps**

|   |   |   |  |
|---|---|---|--|
|  |  |  |  |
| License Plate Holders   | LED License Lamps   | Incandescent License Lamps  |  |
| Pg. 159   | Pg. 159 - 161   | Pg. 159 - 161   |  |

| Trailer Modules   |   |   |   | Trailer Modules |
|---|---|---|---|-----------------|
|  |  |  |  |                 |
| Two Hole w/<br>LED Lamp   | Two Hole w/<br>Incandescent Lamp  | Three Hole w/<br>LED Lamp   | Three Hole w/<br>Incandescent Lamp  |                 |
| Pg. 162 - 164   | Pg. 165   | Pg. 166   | Pg. 166   |                 |

| Tow Light Kits  |   | Tow Light Kits |
|---|---|----------------|
|  |  |                |
| Heavy Duty<br>LED   | Heavy Duty<br>Incandescent  |                |
| Pg. 167   | Pg. 168   |                |

| Bulbs   |   | Bulbs |
|---|---|-------|
|  |  |       |
| Replacement<br>Mini Bulbs   | Replacement<br>Halogen Bulbs  |       |
| Pg. 169   | Pg. 170   |       |



| Back-Up Alarms  |   |   | Back-Up Alarms |
|---|---|---|----------------|
|  |  |  |                |
| 97 dB   | 107 dB  | 112 dB  |                |
| Pg. 171   | Pg. 171   | Pg. 171   |                |

| Mirrors   |   |   | Miroirs |
|---|---|---|---------|
|  |  |  |         |
| Convex Mirrors  | Mirror<br>Accessories   | West Coast<br>Mirrors   |         |
| Pg. 172 - 173   | Pg. 173   | Pg. 174   |         |

| Accessories   |   |   |   |  |   | Accessoires   |
|---|---|---|---|--|---|---|
|    |    |    |    |    |    |    |
| Conspicuity Tape - Rolls  | Conspicuity Tape - 12" Strips   | Rectangular Reflectors  | Round Reflectors  | Oval Reflectors  | Branch Deflectors   | (1" x 2") Base Mounts   |
| Pg. 175   | Pg. 175   | Pg. 176   | Pg. 176   | Pg. 176  | Pg. 177   | Pg. 177   |
|    |    |    |    |    |    |    |
| (1" x 4") Base Mounts   | 3/4" Round Chrome Bezels  | 2" Round Chrome Bezels  | 2.5" Round Chrome Bezels  | Oval Chrome Bezels   | 4" Round Chrome Bezels  | 2" Round ABS Flange   |
| Pg. 177   | Pg. 178   | Pg. 178   | Pg. 178   | Pg. 178  | Pg. 178   | Pg. 179   |
|    |    |    |    |    |    |    |
| 2.5" Round ABS Flange   | Oval ABS Flange   | (4" x 6") SS Flange   | 4" Round Flange   | (1" x 2") Grommets   | 3/4" Round Grommets   | 2" Round Grommets   |
| Pg. 179   | Pg. 179   | Pg. 179   | Pg. 179   | Pg. 180  | Pg. 180   | Pg. 180   |
|   |   |   |   |   |   |   |
| 2.5" Round Grommets   | Oval Grommets   | 4" Round Grommets   | (4" x 6") Grommets  | Mounting Brackets for 2" Round   | Mounting Brackets for 2.5" Round  | Mounting Brackets for Ovals   |
| Pg. 180   | Pg. 180   | Pg. 180   | Pg. 180   | Pg. 180  | Pg. 180   | Pg. 180   |
|  |  |  |  |  |  |  |
| Mounting Brackets for 4" Round  | Mounting Brackets for (4" x 6")   | Single Contact Pigtails   | Double Contact Pigtails   | Trailer Wire Harness   | Trunk Wire Harness  | Wire Harnesses for Trailer Modules  |
| Pg. 180   | Pg. 180   | Pg. 181   | Pg. 182   | Pg. 183  | Pg. 183   | Pg. 183   |
|  |  |  |  |  |  |  |
| Work Lamp Harness   | Snow Plow Plug & Go Harness   | Work Lamp Mount Brackets  | Fuse & Switch Kits  | Camera Systems   | Safety Products   | Other Accessories   |
| Pg. 184   | Pg. 185   | Pg. 186   | Pg. 187   | Pg. 188 - 189  | Pg. 190   | Pg. 191   |

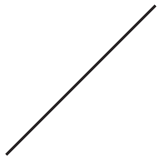

| Sealed Beam Lamps   |   | Sealed Beam Lamps |
|---|---|-------------------|
|  |  |                   |
| PAR36 & PAR46 Work Lamps  | Sealed Beams  |                   |
| Pg. 192   | Pg. 192   |                   |

| Programs & Displays   |   |   | Programs & Displays |
|---|---|---|---------------------|
|  |  |  |                     |
| Worklamp POP Displays   | Snow Plow Sign Board Kits   | Display Programs  |                     |
| Pg. 193   | Pg. 194 - 195   | Pg. 196   |                     |

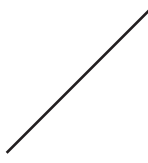
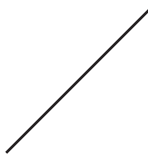
| Technical Information   |   |   | Technical Information |
|---|---|---|-----------------------|
|  |  |  |                       |
| Trailer Lamp Requirements   | SAE Lighting Identification   | IP Rating   |                       |
| Pg. 197 - 198   | Pg. 199   | Pg. 200   |                       |

# LED HEADLAMPS

DOT / SAE Compliant for Legal On The Road Use

DOT / SAE / ECE R112 compliant performance LED driving lamps with state of the art optic system. High lumen output with low power consumption. Finned aluminum body for heat dissipation. Emits natural white light which reduces eye fatigue.



| Part No.           | Opt. Penetration             |
|--------------------|------------------------------|
| <b>LWP6900H-2K</b> | High: 1650 ft / Low: 1110 ft |

|                  |                                      |
|------------------|--------------------------------------|
| High Beam Lumens | 3560                                 |
| Low Beam Lumens  | 1620                                 |
| Function         | High Beam / Low Beam / Signal / Park |
| Voltage          | 10V - 30V                            |
| Amp Draw         | High Beam: 6.7 @ 12V per lamp        |
| Housing          | High UV Resistant Aluminum           |
| Lens             | Tempered Glass                       |
| CISPR25 Rating   | -                                    |
| IP Rating        | IP69K                                |
| EMC              | Certified                            |
| RoHS             | Certified                            |
| Connection       | 5x Lead Wires                        |

### FEATURES & BENEFITS

- Auto ON-OFF Lens Heater
- Dual Lamp Kit (comes with both Driver & Passenger sides)
- Built-In 6-Pin Deutsch Connector (male mating connector included)
- Can be mounted on horizontal or vertical surfaces
- Adjustable Aluminum Alloy Shock Absorbing Mount
- Pressure Relief Vent
- Reverse voltage protection. Hi/Low Voltage input protection

### Accessories

- LWP6900HL** Lamp - Driver Side
- LWP6900HR** Lamp - Passenger Side
- PT6610** 10 ft wire extension harness with mating male Deutsch
- PT8167** 7 ft "Y" harness with (2x) mating male Deutsch receptacle

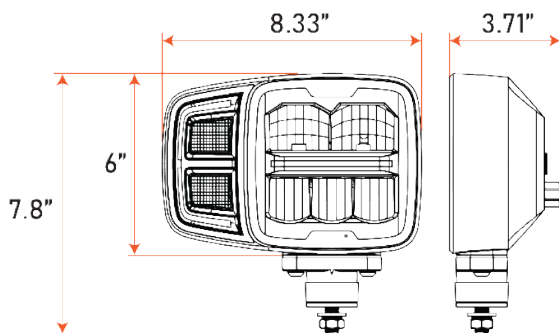

| Part No.        | Opt. Penetration             |
|-----------------|------------------------------|
| <b>LWP6800H</b> | High: 1800 ft / Low: 1000 ft |

|                  |                                      |
|------------------|--------------------------------------|
| High Beam Lumens | 3600                                 |
| Low Beam Lumens  | 1800                                 |
| Function         | High Beam / Low Beam / Signal / Park |
| Voltage          | 10V - 30V                            |
| Amp Draw         | High Beam: 5.5 @ 12V per lamp        |
| Housing          | High UV Resistant Aluminum           |
| Lens             | Tempered Glass                       |
| CISPR25 Rating   | -                                    |
| IP Rating        | IP68                                 |
| EMC              | Certified                            |
| RoHS             | Certified                            |
| Connection       | 5x Lead Wires                        |

### FEATURES & BENEFITS

- Auto ON-OFF Lens Heater
- Can be mounted on either Driver or Passenger sides
- 6-Pin Deutsch Connector (male mating connector included)
- Can be mounted on horizontal or vertical surfaces
- Adjustable Aluminum Alloy Shock Absorbing Mount
- Pressure Relief Vent
- Reverse voltage protection. Hi/Low Voltage input protection

NOTE: Product comes with ONLY ONE Turn Signal

### Accessories

- PT6610** 10 ft wire extension harness with mating male Deutsch receptacle
- PT8167** 7 ft "Y" harness with (2x) mating male Deutsch receptacle

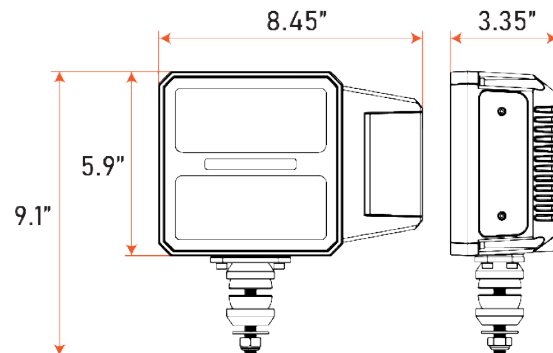

# LED HEADLAMPS

DOT / SAE Compliant for Legal On The Road Use

LED DRIVING LAMPS  
FEUX DE ROUTE DEL



| Part No.          | Opt. Penetration                     |
|-------------------|--------------------------------------|
| <b>LWP1330-2K</b> | High: 1700 ft / Low: 860 ft          |
| High Beam Lumens  | 3600                                 |
| Low Beam Lumens   | 1800                                 |
| Function          | High Beam / Low Beam / Signal / Park |
| Voltage           | 10V - 30V                            |
| Amp Draw          | High Beam: 6.5 @ 12V per lamp        |
| Housing           | High UV Resistant Aluminum           |
| Lens              | Tempered Glass                       |
| CISPR25 Rating    | -                                    |
| IP Rating         | IP68                                 |
| EMC               | Certified                            |
| RoHS              | Certified                            |
| Connection        | 5x Lead Wires                        |

### FEATURES & BENEFITS

- **Auto ON-OFF Lens Heater**
- **Dual Lamp Kit (comes with both Driver & Passenger sides)**
- **6-Pin Deutsch Connector (male mating connector included)**
- **Adjustable Aluminum Alloy Heavy Duty Double Bolt Mount**
- Pressure Relief Vent
- Reverse voltage protection. Hi/Low Voltage input protection

### Accessories

- LWP1330L** Lamp - Driver Side
- LWP1330R** Lamp - Passenger Side
- PT6610** 10 ft wire extension harness with mating male Deutsch
- PT8167** 7 ft "Y" harness with (2x) mating male Deutsch receptacle

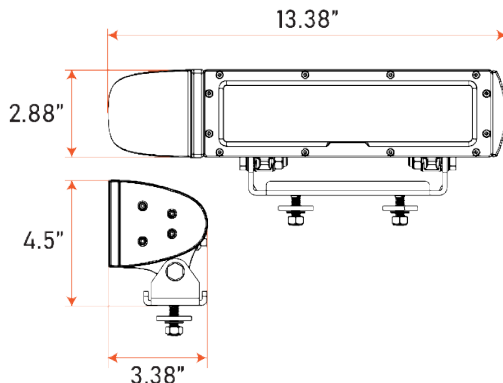

**HEAVY DUTY & AUTO ON-OFF MOUNTING & HEATED LENS**

**MADE FOR THE TOUGHEST OF ROADS & WEATHER**



# LED AUXILIARY HIGH BEAM LAMPS

## Legal On The Road Use

DOT / SAE / ECE R112 compliant performance LED driving lamps with state of the art optic system. High lumen output with low power consumption. Finned aluminum body for heat dissipation. Emits natural white light which reduces eye fatigue.



| Part No.      | Opt. Penetration | Colour |
|---------------|------------------|--------|
| <b>LW9023</b> | 2900 ft          | White  |

| Part No.      | Opt. Penetration | Colour |
|---------------|------------------|--------|
| <b>LW7023</b> | 2300 ft          | White  |

|                  |                            |
|------------------|----------------------------|
| Raw Lumens       | 12500                      |
| Effective Lumens | 7000                       |
| SAE              | (Y) J581                   |
| LED              | 37 x 5W                    |
| Voltage          | 10V - 30V                  |
| Amp Draw         | 10.0 @ 12V                 |
| Housing          | High UV Resistant Aluminum |
| Lens             | Polycarbonate              |
| CISPR25 Rating   | -                          |
| IP Rating        | IP67                       |
| EMC              | Certified                  |
| RoHS             | -                          |
| Connection       | 4x Lead Wires              |

|                  |                            |
|------------------|----------------------------|
| Raw Lumens       | 8500                       |
| Effective Lumens | 5100                       |
| SAE              | (Y) J581                   |
| LED              | 19 x 5W                    |
| Voltage          | 10V - 30V                  |
| Amp Draw         | 6.23 @ 12V                 |
| Housing          | High UV Resistant Aluminum |
| Lens             | Polycarbonate              |
| CISPR25 Rating   | -                          |
| IP Rating        | IP69K                      |
| EMC              | Certified                  |
| RoHS             | -                          |
| Connection       | 4x Lead Wires              |

### FEATURES & BENEFITS

- White / Amber Halo Light
- Adjustable Black Powder Coated Iron Mounting Bracket
- Built-In 4-Pin Deutsch Connector (male mating connector included)
- Reverse voltage protection. Hi/Low Voltage input protection

### FEATURES & BENEFITS

- White / Amber Halo Light
- Adjustable Black Powder Coated Iron Mounting Bracket
- Built-In 4-Pin Deutsch Connector (male mating connector included)
- Reverse voltage protection. Hi/Low Voltage input protection

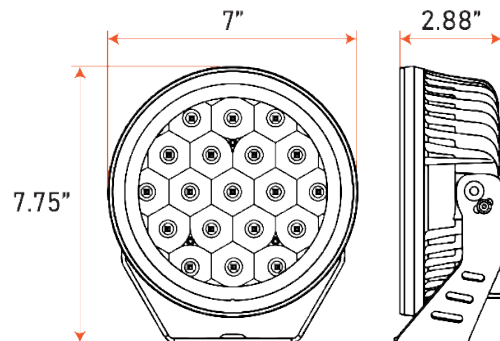
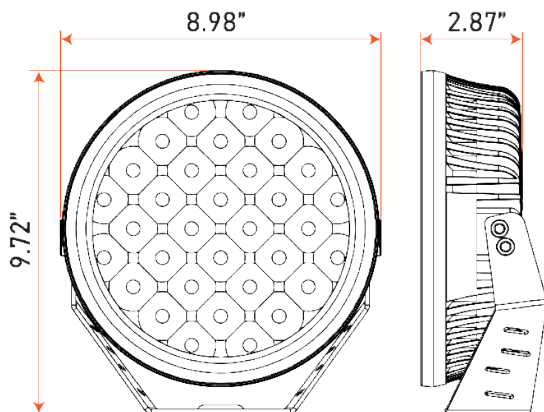

# LED AUXILIARY HIGH BEAM LAMPS

Legal On The Road Use

LED DRIVING LAMPS  
FEUX DE ROUTE DEL



| Part No.      | Opt. Penetration | Colour |
|---------------|------------------|--------|
| <b>LW5700</b> | 1650 ft          | Clear  |

| Part No.      | Opt. Penetration | Colour |
|---------------|------------------|--------|
| <b>LW5023</b> | 1300 ft          | White  |

|                  |                            |
|------------------|----------------------------|
| Raw Lumens       | 1890                       |
| Effective Lumens | -                          |
| SAE              | (Y) J581                   |
| LED              | 1 x 20W (17W)              |
| Voltage          | 12V - 24V                  |
| Amp Draw         | 1.3 @ 12V                  |
| Housing          | High UV Resistant Aluminum |
| Lens             | Polycarbonate              |
| CISPR25 Rating   | -                          |
| IP Rating        | IP69K                      |
| EMC              | Certified                  |
| RoHS             | Certified                  |
| Connection       | 2x Lead Wires              |

|                  |                            |
|------------------|----------------------------|
| Raw Lumens       | 4000                       |
| Effective Lumens | 2800                       |
| SAE              | (Y) J581                   |
| LED              | 12 x 5W                    |
| Voltage          | 10V - 30V                  |
| Amp Draw         | 4.53 @ 12V                 |
| Housing          | High UV Resistant Aluminum |
| Lens             | Polycarbonate              |
| CISPR25 Rating   | -                          |
| IP Rating        | IP67                       |
| EMC              | Certified                  |
| RoHS             | -                          |
| Connection       | 4x Lead Wires              |

## FEATURES & BENEFITS

- Adjustable Stainless Steel Mounting Bracket
- Reverse voltage protection.

## FEATURES & BENEFITS

- White / Amber Halo Light
- Adjustable Black Powder Coated Iron Mounting Bracket
- Built-In 4-Pin Deutsch Connector (male mating connector included)
- Reverse voltage protection. Hi/Low Voltage input protection

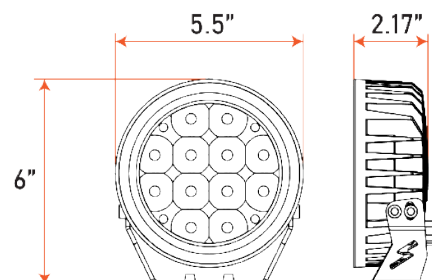
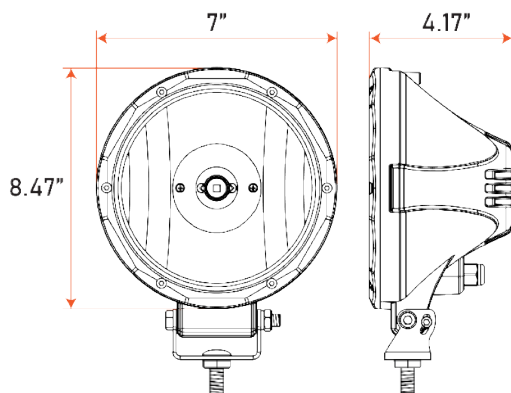



# LED AUXILIARY HIGH BEAM LAMPS

## Legal On The Road Use

DOT / SAE / ECE R112 compliant performance LED driving lamps with state of the art optic system. High lumen output with low power consumption. Finned aluminum body for heat dissipation. Emits natural white light which reduces eye fatigue.



| Part No.      | Opt. Penetration | Colour |
|---------------|------------------|--------|
| <b>LW2643</b> | 2050 ft          | White  |

| Part No.      | Opt. Penetration | Colour |
|---------------|------------------|--------|
| <b>LW5310</b> | 1550 ft          | Clear  |

|                  |                            |
|------------------|----------------------------|
| Raw Lumens       | 6600                       |
| Effective Lumens | -                          |
| SAE              | ECE R-112                  |
| LED              | 6 x 10W                    |
| Voltage          | 12V - 60V                  |
| Amp Draw         | 3.9 @ 12V                  |
| Housing          | High UV Resistant Aluminum |
| Lens             | Polycarbonate              |
| CISPR25 Rating   | Class 4                    |
| IP Rating        | IP69K                      |
| EMC              | Certified                  |
| RoHS             | Certified                  |
| Connection       | 2x Lead Wires              |

|                  |                            |
|------------------|----------------------------|
| Raw Lumens       | 2346                       |
| Effective Lumens | 1642                       |
| SAE              | (Y) J581                   |
| LED              | (2 x 3W) + (2 x 10W)       |
| Voltage          | 9V - 32V                   |
| Amp Draw         | 1.75 @ 12V                 |
| Housing          | High UV Resistant Aluminum |
| Lens             | Polycarbonate              |
| CISPR25 Rating   | -                          |
| IP Rating        | IP69K                      |
| EMC              | Certified                  |
| RoHS             | Certified                  |
| Connection       | 2x Lead Wires              |

### FEATURES & BENEFITS

- European Union Regulation ECE R-112 for Canadian Highway Use
- Electronic Thermal Management to control lamp temperature
- Deutsch Connector (male mating connector included)
- Adjustable Stainless Steel Heavy Duty Mounting Bracket
- Pressure Relief Vent
- Reverse voltage protection. Hi/Low voltage input protection

### FEATURES & BENEFITS

- Deutsch Connector (male mating connector included)
- Adjustable Stainless Steel Mounting Bracket
- Reverse voltage protection. Voltage surge protection

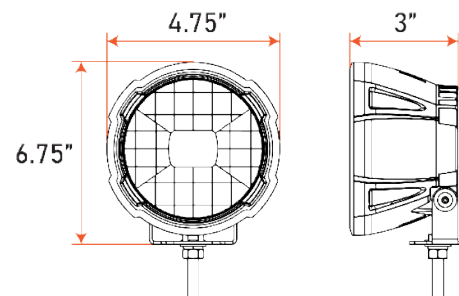
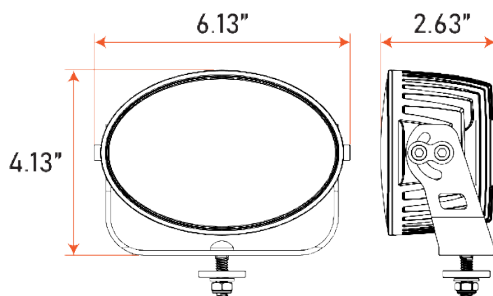

# LED AUXILIARY HIGH BEAM LAMPS

Legal On The Road Use

LED DRIVING LAMPS  
FEUX DE ROUTE DEL



| Part No.           | Opt. Penetration | Colour |
|--------------------|------------------|--------|
| <b>LW0438AW-2K</b> | 580 ft           | White  |

| Part No.       | Opt. Penetration | Colour |
|----------------|------------------|--------|
| <b>LW0313E</b> | 1640 ft          | Clear  |

|                  |   |
|------------------|---|
| Raw Lumens       | 3600  |
| Effective Lumens | 2900  |
| SAE              | High Beam: (Y) J581 / Warning: J595 Class 1 |
| LED              | High Beam: (2 x 20W) + Warning: (4 x 3W)    |
| Voltage          | 9V - 36V                                    |
| Amp Draw         | 2.7 @ 12V per lamp                          |
| Housing          | High UV Resistant Aluminum                  |
| Lens             | Polycarbonate                               |
| CISPR25 Rating   | Class 4                                     |
| IP Rating        | IP68  |
| EMC              | Certified                                   |
| RoHS             | -   |
| Connection       | 2x Lead Wires                               |

|                  |  |
|------------------|--|
| Raw Lumens       | 3600                                       |
| Effective Lumens | 2520                                       |
| SAE              | Driving: ECE R149 / Position: ECE R148     |
| LED              | Driving: (8 x 4.5W) + Position: (8 x 0.2W) |
| Voltage          | 10V - 30V                                  |
| Amp Draw         | 2.6 @ 12V                                  |
| Housing          | High UV Resistant Aluminum                 |
| Lens             | Polycarbonate                              |
| CISPR25 Rating   | -  |
| IP Rating        | IP69K                                      |
| EMC              | Certified                                  |
| RoHS             | Certified                                  |
| Connection       | 2x Lead Wires                              |

## FEATURES & BENEFITS

- **Dual Lamp Kit with Plug & Go Harness, Switch, Relay & Fuse**
- **Synchronize Warning Lights to Flash Simultaneously or Alternating**
- **Electronic Thermal Management to control lamp temperature**
- **Sealed Deutsch Connectors**
- **Adjustable Stainless Steel Mounting Bracket**
- Reverse voltage protection. Hi/Low voltage input protection

## FEATURES & BENEFITS

- **Super Wide Beam (160°) with Side Shooters**
- **Adjustable Stainless Steel Mounting Bracket**
- Pressure Relief Vent
- Reverse voltage protection. Voltage surge protection

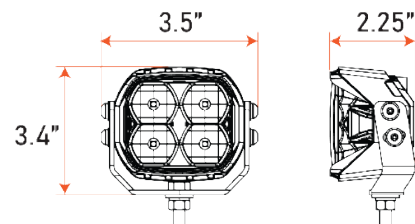
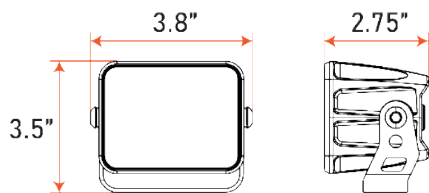

# LED AUXILIARY HIGH BEAM LAMPS

## Legal On The Road Use

DOT / SAE / ECE R112 compliant performance LED driving lamps with state of the art optic system. High lumen output with low power consumption. Finned aluminum body for heat dissipation. Emits natural white light which reduces eye fatigue.



| Part No.       | Opt. Penetration | Colour |
|----------------|------------------|--------|
| <b>LW79209</b> | 1400 ft          | Clear  |

|                  |                                   |
|------------------|-----------------------------------|
| Raw Lumens       | 1410                              |
| Effective Lumens | -                                 |
| SAE              | (Y) J581                          |
| LED              | 15 x 3W OSRAM                     |
| Voltage          | 12V - 24V                         |
| Amp Draw         | 1.3 @ 12V                         |
| Housing          | High UV Resistant Aluminum        |
| Lens             | Polycarbonate                     |
| CISPR25 Rating   | -                                 |
| IP Rating        | IP69K                             |
| EMC              | Certified                         |
| RoHS             | Certified                         |
| Connection       | Plug & Go Harness - 2x Lead Wires |

### FEATURES & BENEFITS

- 18 ft Plug & Go Harness with ON-OFF Switch, Relay & Fuse
- Adjustable Stainless Steel Heavy Duty Mounting Bracket
- Pressure Relief Vent
- Reverse voltage protection. Hi/Low voltage input protection

### Accessories

**LWM9090** Tamper proof hardware kit

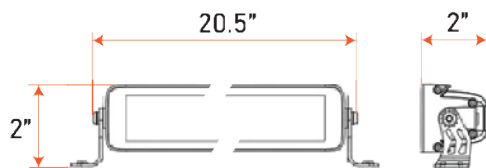

**UNI-BOND  
LED Safety Whips**  
made for ALL applications

For More Info, Check Out  
Pg. 96 - 99

# ULTRA SERIES

Ultra Bright, Ultra Powerful - For Off-Road Applications

LED WORK LAMPS  
LAMPES DE TRAVAIL DEL

ULTRA series LED lamps are HIGH LUMEN lamps with state of the art optic system. Equipped with Electronic Thermal Management System to prevent lamp from overheating. Finned aluminum body for heat dissipation. Emits natural white light which reduces eye fatigue.



| Part No.      | Beam Pattern | Opt. Penetration | Colour |
|---------------|--------------|------------------|--------|
| <b>LW4329</b> | Flood        | 650 ft           | White  |

| Part No.      | Beam Pattern | Opt. Penetration | Colour |
|---------------|--------------|------------------|--------|
| <b>LW4339</b> | Spot         | 2400 ft          | White  |

|                  |                            |
|------------------|----------------------------|
| Raw Lumens       | 21600                      |
| Effective Lumens | 10400                      |
| LED              | 36 x 5W OSRAM              |
| Voltage          | 10V - 30V                  |
| Amp Draw         | 10.0 @ 12V                 |
| Housing          | High UV Resistant Aluminum |
| Lens             | Polycarbonate              |
| CISPR25 Rating   | -                          |
| IP Rating        | IP69K                      |
| EMC              | Certified                  |
| RoHS             | Certified                  |
| Connection       | 2x Lead Wires              |

|                  |                            |
|------------------|----------------------------|
| Raw Lumens       | 5400                       |
| Effective Lumens | 3750                       |
| LED              | 9 x 5W OSRAM               |
| Voltage          | 10V - 30V                  |
| Amp Draw         | 3.8 @ 12V                  |
| Housing          | High UV Resistant Aluminum |
| Lens             | Polycarbonate              |
| CISPR25 Rating   | -                          |
| IP Rating        | IP69K                      |
| EMC              | Certified                  |
| RoHS             | Certified                  |
| Connection       | 2x Lead Wires              |

### FEATURES & BENEFITS

- Electronic Thermal Management to control lamp temperature
- Sealed Deutsch Connector (both female & male mating connectors)
- Adjustable Stainless Steel Heavy Duty Mounting Bracket
- Reverse voltage protection

### FEATURES & BENEFITS

- Electronic Thermal Management to control lamp temperature
- Sealed Deutsch Connector (both female & male mating connectors)
- Adjustable Stainless Steel Heavy Duty Mounting Bracket
- Reverse voltage protection

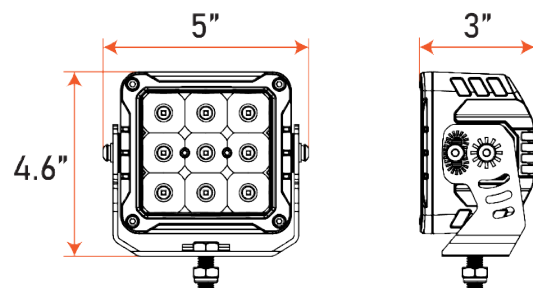
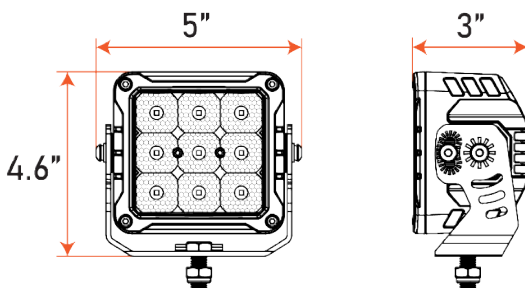

# ULTRA SERIES

Ultra Bright, Ultra Powerful - For Off-Road Applications

ULTRA series LED lamps are HIGH LUMEN lamps with state of the art optic system. Equipped with Electronic Thermal Management System to prevent lamp from overheating. Finned aluminum body for heat dissipation. Emits natural white light which reduces eye fatigue.



| Part No.      | Beam Pattern | Opt. Penetration | Colour |
|---------------|--------------|------------------|--------|
| <b>LW4139</b> | Spot         | 1750 ft          | White  |

| Part No.      | Beam Pattern | Opt. Penetration | Colour |
|---------------|--------------|------------------|--------|
| <b>LW5342</b> | Flood        | 670 ft           | White  |

|               |      |         |       |
|---------------|------|---------|-------|
| <b>LW5343</b> | Spot | 2300 ft | White |
|---------------|------|---------|-------|

|                  |                            |
|------------------|----------------------------|
| Raw Lumens       | 4800                       |
| Effective Lumens | 3000                       |
| LED              | 4 x 10W OSRAM              |
| Voltage          | 10V - 30V                  |
| Amp Draw         | 3.7 @ 12V                  |
| Housing          | High UV Resistant Aluminum |
| Lens             | Polycarbonate              |
| CISPR25 Rating   | -                          |
| IP Rating        | IP69K                      |
| EMC              | Certified                  |
| RoHS             | Certified                  |
| Connection       | 2x Lead Wires              |

|                  |                            |
|------------------|----------------------------|
| Raw Lumens       | 14400                      |
| Effective Lumens | 10130                      |
| LED              | 12 x 10W                   |
| Voltage          | 10V - 30V                  |
| Amp Draw         | 9.0 @ 12V                  |
| Housing          | High UV Resistant Aluminum |
| Lens             | Polycarbonate              |
| CISPR25 Rating   | -                          |
| IP Rating        | IP69K                      |
| EMC              | Certified                  |
| RoHS             | Certified                  |
| Connection       | 2x Lead Wires              |

### FEATURES & BENEFITS

- Electronic Thermal Management to control lamp temperature
- Sealed Deutsch Connector (both female & male mating connectors)
- Adjustable Stainless Steel Heavy Duty Mounting Bracket
- Reverse voltage protection

### FEATURES & BENEFITS

- Electronic Thermal Management to control lamp temperature
- Built-In ATP Connector (male mating connector included)
- Adjustable Stainless Steel Heavy Duty Shock Absorbing Mount
- Pressure Relief Valve. Reverse voltage protection

|                    |                      |
|--------------------|----------------------|
| <b>LWCR5343-A</b>  | Amber Lens Cover     |
| <b>LWCR5343-BK</b> | Black-Out Lens Cover |

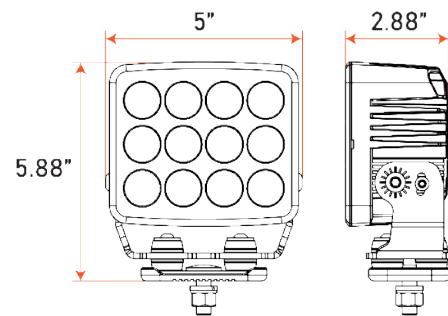
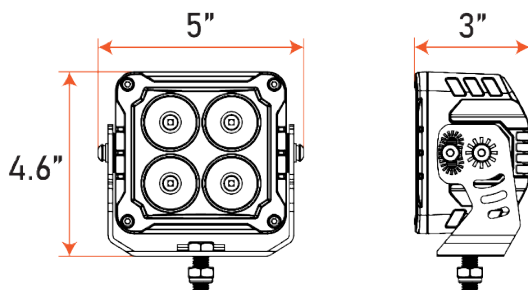



# ULTRA SERIES

Ultra Bright, Ultra Powerful - For Off-Road Applications

LED WORK LAMPS  
LAMPES DE TRAVAIL DEL

LW5429



LW5439



LW5429A



| Part No. | Beam Pattern | Opt. Penetration | Colour |
|----------|--------------|------------------|--------|
| LW5429   | Flood        | 830 ft           | White  |
| LW5439   | Spot         | 2400 ft          | White  |

| Part No. | Beam Pattern | Opt. Penetration | Colour |
|----------|--------------|------------------|--------|
| LW5429A  | Flood        | 690 ft           | Amber  |

|                  |                            |
|------------------|----------------------------|
| Raw Lumens       | 10500                      |
| Effective Lumens | 7500                       |
| LED              | 9 x 10W                    |
| Voltage          | 10V - 30V                  |
| Amp Draw         | 7.5 @ 12V                  |
| Housing          | High UV Resistant Aluminum |
| Lens             | Polycarbonate              |
| CISPR25 Rating   | Class 5                    |
| IP Rating        | IP69K                      |
| EMC              | Certified                  |
| RoHS             | Certified                  |
| Connection       | 2x Lead Wires              |

|                  |                            |
|------------------|----------------------------|
| Raw Lumens       | 9700                       |
| Effective Lumens | 6900                       |
| LED              | 9 x 10W                    |
| Voltage          | 10V - 30V                  |
| Amp Draw         | 7.5 @ 12V                  |
| Housing          | High UV Resistant Aluminum |
| Lens             | Polycarbonate              |
| CISPR25 Rating   | Class 5                    |
| IP Rating        | IP69K                      |
| EMC              | Certified                  |
| RoHS             | Certified                  |
| Connection       | 2x Lead Wires              |

### FEATURES & BENEFITS

- Shock Resistance Tested for 60G
- Electronic Thermal Management to control lamp temperature
- Built-In Deutsch Connector (male mating connector included)
- Adjustable Stainless Steel Heavy Duty Shock Absorbing Mount
- Reverse voltage protection

### FEATURES & BENEFITS

- Shock Resistance Tested for 60G
- Electronic Thermal Management to control lamp temperature
- Built-In Deutsch Connector (male mating connector included)
- Adjustable Stainless Steel Heavy Duty Shock Absorbing Mount
- Reverse voltage protection

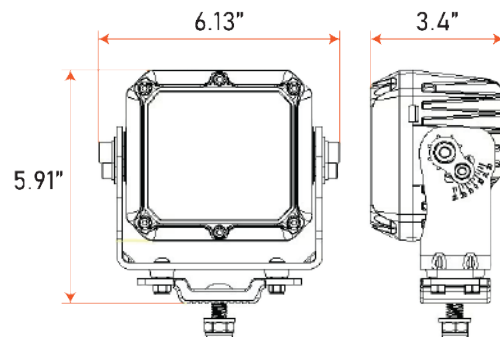
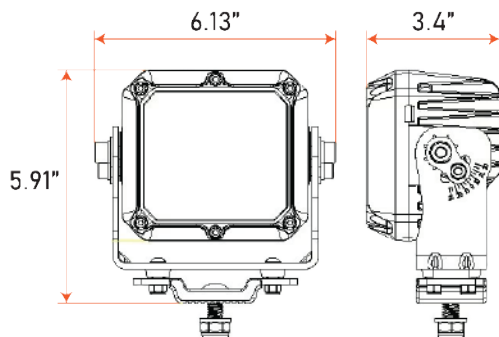

# ULTRA SERIES

Ultra Bright, Ultra Powerful - For Off-Road Applications

ULTRA series LED lamps are HIGH LUMEN lamps with state of the art optic system. Equipped with Electronic Thermal Management System to prevent lamp from overheating. Finned aluminum body for heat dissipation. Emits natural white light which reduces eye fatigue.

LW4429



LW4439



LW4429A



| Part No. | Beam Pattern | Opt. Penetration | Colour |
|----------|--------------|------------------|--------|
| LW4429   | Flood        | 670 ft           | White  |
| LW4439   | Spot         | 1600 ft          | White  |

|                  |                            |
|------------------|----------------------------|
| Raw Lumens       | 7000                       |
| Effective Lumens | 4800                       |
| LED              | 6 x 10W                    |
| Voltage          | 10V - 30V                  |
| Amp Draw         | 5.0 @ 12V                  |
| Housing          | High UV Resistant Aluminum |
| Lens             | Polycarbonate              |
| CISPR25 Rating   | Class 5                    |
| IP Rating        | IP69K                      |
| EMC              | Certified                  |
| RoHS             | Certified                  |
| Connection       | 2x Lead Wires              |

## FEATURES & BENEFITS

- Shock Resistance Tested for 60G
- Electronic Thermal Management to control lamp temperature
- Built-In Deutsch Connector (male mating connector included)
- Adjustable Stainless Steel Heavy Duty Shock Absorbing Mount
- Reverse voltage protection

| Part No. | Beam Pattern | Opt. Penetration | Colour |
|----------|--------------|------------------|--------|
| LW4429A  | Flood        | 590 ft           | Amber  |

|                  |                            |
|------------------|----------------------------|
| Raw Lumens       | 6500                       |
| Effective Lumens | 4400                       |
| LED              | 6 x 10W                    |
| Voltage          | 10V - 30V                  |
| Amp Draw         | 5.0 @ 12V                  |
| Housing          | High UV Resistant Aluminum |
| Lens             | Polycarbonate              |
| CISPR25 Rating   | Class 5                    |
| IP Rating        | IP69K                      |
| EMC              | Certified                  |
| RoHS             | Certified                  |
| Connection       | 2x Lead Wires              |

## FEATURES & BENEFITS

- Shock Resistance Tested for 60G
- Electronic Thermal Management to control lamp temperature
- Built-In Deutsch Connector (male mating connector included)
- Adjustable Stainless Steel Heavy Duty Shock Absorbing Mount
- Reverse voltage protection

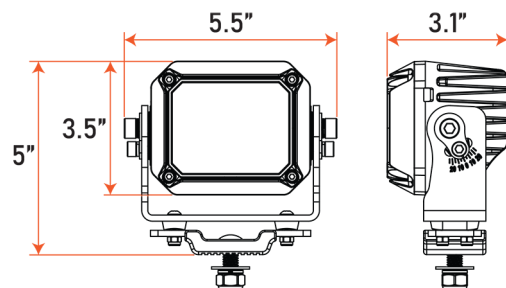
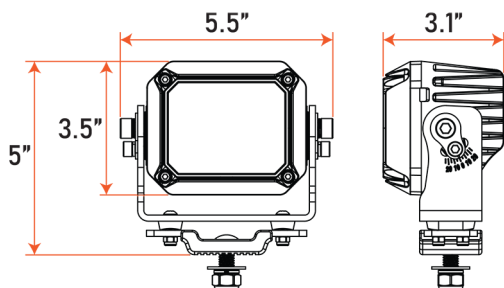

# ULTRA SERIES

Ultra Bright, Ultra Powerful - For Off-Road Applications

LED WORK LAMPS  
LAMPES DE TRAVAIL DEL



| Part No.       | Beam Pattern | Opt. Penetration | Colour |
|----------------|--------------|------------------|--------|
| <b>LW55259</b> | Wide Flood   | 660 ft           | White  |

| Part No.       | Beam Pattern | Opt. Penetration | Colour |
|----------------|--------------|------------------|--------|
| <b>LW45259</b> | Wide Flood   | 510 ft           | White  |

|                  |                            |
|------------------|----------------------------|
| Raw Lumens       | 9600                       |
| Effective Lumens | 7800                       |
| LED              | 6 x 18W                    |
| Voltage          | 9V - 36V                   |
| Amp Draw         | 7.2 @ 12V                  |
| Housing          | High UV Resistant Aluminum |
| Lens             | Polycarbonate              |
| CISPR25 Rating   | Class 5                    |
| IP Rating        | IP68                       |
| EMC              | Certified                  |
| RoHS             | Certified                  |
| Connection       | 2x Lead Wires              |

|                  |                            |
|------------------|----------------------------|
| Raw Lumens       | 6400                       |
| Effective Lumens | 5500                       |
| LED              | 4 x 18W                    |
| Voltage          | 9V - 36V                   |
| Amp Draw         | 5.0 @ 12V                  |
| Housing          | High UV Resistant Aluminum |
| Lens             | Polycarbonate              |
| CISPR25 Rating   | Class 5                    |
| IP Rating        | IP68                       |
| EMC              | Certified                  |
| RoHS             | Certified                  |
| Connection       | 2x Lead Wires              |

### FEATURES & BENEFITS

- **Electronic Thermal Management** to control lamp temperature
- **Built-In Deutsch Connector** (male mating connector included)
- **Adjustable Stainless Steel Heavy Duty Mounting Bracket**
- Reverse voltage protection

### FEATURES & BENEFITS

- **Electronic Thermal Management** to control lamp temperature
- **Built-In Deutsch Connector** (male mating connector included)
- **Adjustable Stainless Steel Heavy Duty Mounting Bracket**
- Reverse voltage protection

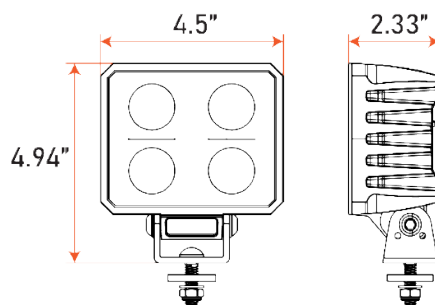
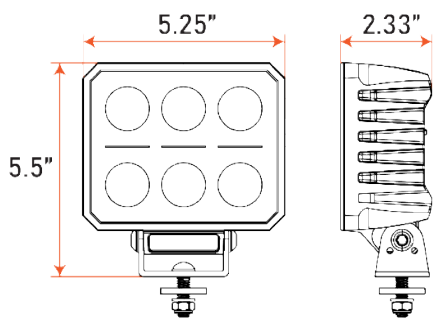

# ULTRA SERIES

Ultra Bright, Ultra Powerful - For Off-Road Applications

ULTRA series LED lamps are HIGH LUMEN lamps with state of the art optic system. Equipped with Electronic Thermal Management System to prevent lamp from overheating. Finned aluminum body for heat dissipation. Emits natural white light which reduces eye fatigue.

LW4529



LW4029-5



LW4229-5



| Part No. | Beam Pattern | Opt. Penetration | Colour |
|----------|--------------|------------------|--------|
| LW4529   | Wide Flood   | 575 ft           | Amber  |

| Part No. | Beam Pattern | Opt. Penetration | Colour |
|----------|--------------|------------------|--------|
| LW4029-5 | Wide Flood   | 450 ft           | White  |
| LW4229-5 | Wide Flood   | 450 ft           | White  |

|                  |                            |
|------------------|----------------------------|
| Raw Lumens       | 14400                      |
| Effective Lumens | 7400                       |
| LED              | 16 x 6W OSRAM              |
| Voltage          | 10V - 30V                  |
| Amp Draw         | 7.7 @ 12V                  |
| Housing          | High UV Resistant Aluminum |
| Lens             | Polycarbonate              |
| CISPR25 Rating   | -                          |
| IP Rating        | IP69K                      |
| EMC              | Certified                  |
| RoHS             | Certified                  |
| Connection       | 2x Lead Wires              |

|                  |                            |
|------------------|----------------------------|
| Raw Lumens       | 8100                       |
| Effective Lumens | 5200                       |
| LED              | 9 x 6W OSRAM               |
| Voltage          | 10V - 30V                  |
| Amp Draw         | 5.4 @ 12V                  |
| Housing          | High UV Resistant Aluminum |
| Lens             | Polycarbonate              |
| CISPR25 Rating   | -                          |
| IP Rating        | IP69K                      |
| EMC              | Certified                  |
| RoHS             | Certified                  |
| Connection       | 2-Pin Deutsch              |

### FEATURES & BENEFITS

- Electronic Thermal Management to control lamp temperature
- Built-In Deutsch Connector (male mating connector included)
- Adjustable Stainless Steel Mounting Bracket
- Reverse voltage protection

### FEATURES & BENEFITS

- Electronic Thermal Management to control lamp temperature
- Female Deutsch Connector
- Adjustable Stainless Steel Mounting Bracket
- Reverse voltage protection

### Accessories

**PT6800-5** 10" wire piece with mating Male Deutsch receptacle

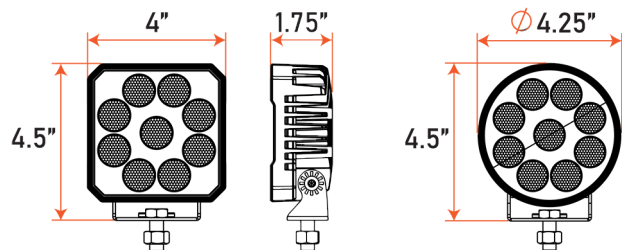
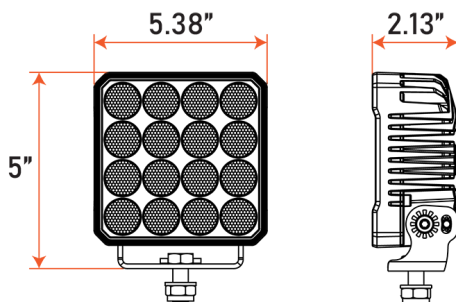

# ULTRA SERIES

Ultra Bright, Ultra Powerful - For Off-Road Applications

LED WORK LAMPS  
LAMPES DE TRAVAIL DEL

LW3029



LW3229



| Part No. | Beam Pattern | Opt. Penetration | Colour |
|----------|--------------|------------------|--------|
| LW3029   | Wide Flood   | 325 ft           | White  |
| LW3229   | Wide Flood   | 325 ft           | White  |

|                  |                            |
|------------------|----------------------------|
| Raw Lumens       | 3600                       |
| Effective Lumens | 2200                       |
| LED              | 4 x 6W OSRAM               |
| Voltage          | 10V - 30V                  |
| Amp Draw         | 2.5 @ 12V                  |
| Housing          | High UV Resistant Aluminum |
| Lens             | Polycarbonate              |
| CISPR25 Rating   | -                          |
| IP Rating        | IP69K                      |
| EMC              | Certified                  |
| RoHS             | Certified                  |
| Connection       | 2x Lead Wires              |

**FEATURES & BENEFITS**

- **Electronic Thermal Management to control lamp temperature**
- **Adjustable Stainless Steel Mounting Bracket**
- Reverse voltage protection

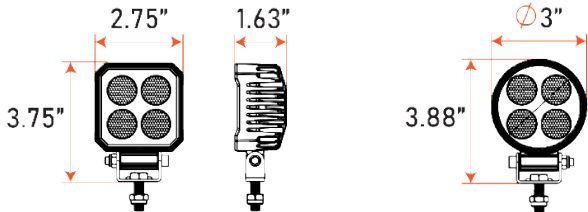

**Reliable ULTRA Series!  
Get the Job Done Safely!**



**When All You Want Is  
Daytime At Night**





# ULTRA NXT SERIES

Ultra Bright & Comfort - For Off-Road Applications

ULTRA NXT series LED lamps are HIGH LUMEN lamps with state of the art optic system & precision equipment. Anti-glare reflectors are next generation tech in improving road safety with LEDs reaching far greater brightness. Equipped with Electronic Thermal Management System to prevent lamp from overheating. Finned aluminum body for heat dissipation. Drive with comfort, drive with confidence.

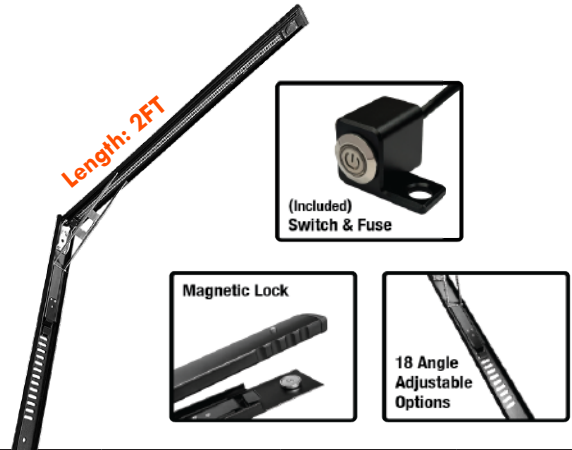

| Part No.      | Beam Pattern | Opt. Penetration | Colour |
|---------------|--------------|------------------|--------|
| <b>LW0328</b> | Flood        | 530 ft           | White  |
| <b>LW0338</b> | Spot         | 1900 ft          | White  |

| Part No.       | Beam Pattern | Opt. Penetration | Colour |
|----------------|--------------|------------------|--------|
| <b>LW06248</b> | Flood        | 450 ft           | White  |

|                  |                            |
|------------------|----------------------------|
| Raw Lumens       | 4800                       |
| Effective Lumens | 3110 ~ 1810                |
| LED              | 4 x 10W                    |
| Voltage          | 12V - 30V                  |
| Amp Draw         | 3.4 @ 12V                  |
| Housing          | High UV Resistant Aluminum |
| Lens             | Polycarbonate              |
| CISPR25 Rating   | -                          |
| IP Rating        | IP69K                      |
| EMC              | Certified                  |
| RoHS             | Certified                  |
| Connection       | 2x Lead Wires              |

|                  |                            |
|------------------|----------------------------|
| Raw Lumens       | 2400                       |
| Effective Lumens | -                          |
| LED              | 236 x 0.1W                 |
| Voltage          | 12V                        |
| Amp Draw         | 2.3 @ 12V                  |
| Housing          | High UV Resistant Aluminum |
| Lens             | Epoxy LED Strip            |
| CISPR25 Rating   | -                          |
| IP Rating        | IP69K                      |
| EMC              | Certified                  |
| RoHS             | Certified                  |
| Connection       | 2x Lead Wires              |

### FEATURES & BENEFITS

- **Anti-Glare Reflectors**
- **Electronic Thermal Management to control lamp temperature**
- **Deutsch Connector (male mating connector included)**
- **Adjustable Stainless Steel Mounting Bracket**
- Pressure relief vent
- Reverse voltage protection

### FEATURES & BENEFITS

- **ON-OFF Switch & Fuse (included)**
- **Foldable Application with Magnetic Lock**
- **18 Angle Adjustable Surface Mount**
- Reverse voltage protection

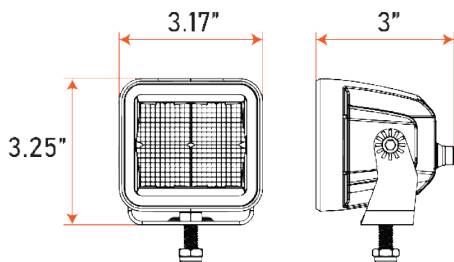

# C.O.B SERIES

Low Wattage & Uniform Light Spread - For Off-Road Applications

C.O.B (Chip On Board) LEDs are designed to provide a uniform spread of light output. Low wattage lamps means you save cost on running the light.

LED WORK LAMPS  
LAMPES DE TRAVAIL DEL



| Part No.      | Beam Pattern | Opt. Penetration | Colour |
|---------------|--------------|------------------|--------|
| <b>LW1542</b> | Wide Flood   | 425 ft           | White  |

| Part No.      | Beam Pattern | Opt. Penetration | Colour |
|---------------|--------------|------------------|--------|
| <b>LW1332</b> | Wide Flood   | 350 ft           | White  |

|                  |                            |
|------------------|----------------------------|
| Raw Lumens       | 4200                       |
| Effective Lumens | -                          |
| LED              | 35W COB                    |
| Voltage          | 12V - 30V                  |
| Amp Draw         | 3.0 @ 12V                  |
| Housing          | High UV Resistant Aluminum |
| Lens             | Polycarbonate              |
| CISPR25 Rating   | Class 3                    |
| IP Rating        | IP69K                      |
| EMC              | Certified                  |
| RoHS             | Certified                  |
| Connection       | 2x Lead Wires              |

|                  |                            |
|------------------|----------------------------|
| Raw Lumens       | 2800                       |
| Effective Lumens | -                          |
| LED              | 25W COB                    |
| Voltage          | 12V - 30V                  |
| Amp Draw         | 2.0 @ 12V                  |
| Housing          | High UV Resistant Aluminum |
| Lens             | Polycarbonate              |
| CISPR25 Rating   | Class 3                    |
| IP Rating        | IP69K                      |
| EMC              | Certified                  |
| RoHS             | Certified                  |
| Connection       | 2x Lead Wires              |

### FEATURES & BENEFITS

- C.O.B LED for Uniform Light Spread
- Spot Beam Pattern with Flood Beam Penetration
- Adjustable Stainless Steel Mounting Bracket
- Pressure relief vent
- Reverse voltage protection

### FEATURES & BENEFITS

- C.O.B LED for Uniform Light Spread
- Spot Beam Pattern with Flood Beam Penetration
- Adjustable Stainless Steel Mounting Bracket
- Reverse voltage protection

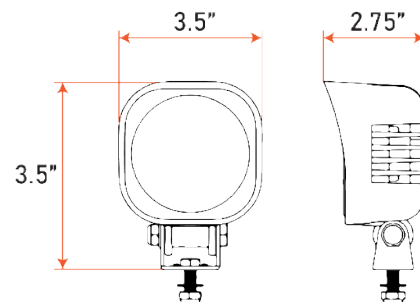
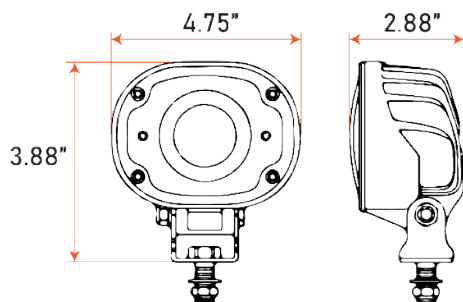



# STANDARD SERIES

Bright & Practical - For Off-Road Applications

A variety of performance LED work lamps. State of the art optic system. High lumen output with low power consumption. Finned aluminum body for heat dissipation. Emits natural white light which reduces eye fatigue.

LW5352



LW5353



| Part No. | Beam Pattern | Opt. Penetration | Colour |
|----------|--------------|------------------|--------|
| LW5352   | Wide Flood   | 390 ft           | White  |
| LW5353   | Spot         | 2000 ft          | White  |

| Part No. | Beam Pattern | Opt. Penetration | Colour |
|----------|--------------|------------------|--------|
| LW5543   | Spot         | 1500 ft          | White  |

|                  |                            |
|------------------|----------------------------|
| Raw Lumens       | 8100                       |
| Effective Lumens | -                          |
| LED              | 9 x 10W                    |
| Voltage          | 12V - 30V                  |
| Amp Draw         | 5.4 @ 12V                  |
| Housing          | High UV Resistant Aluminum |
| Lens             | Polycarbonate              |
| CISPR25 Rating   | -                          |
| IP Rating        | IP69K                      |
| EMC              | Certified                  |
| RoHS             | Certified                  |
| Connection       | 2x Lead Wires              |

|                  |                            |
|------------------|----------------------------|
| Raw Lumens       | 7800                       |
| Effective Lumens | -                          |
| LED              | 24 x 5W                    |
| Voltage          | 12V - 60V                  |
| Amp Draw         | 6.5 @ 12V                  |
| Housing          | High UV Resistant Aluminum |
| Lens             | Polycarbonate              |
| CISPR25 Rating   | Class 3                    |
| IP Rating        | IP69K                      |
| EMC              | Certified                  |
| RoHS             | Certified                  |
| Connection       | 2x Lead Wires              |

## FEATURES & BENEFITS

- **Deutsch Connector (male mating connector included)**
- **Adjustable Stainless Steel Heavy Duty Shock Absorbing Mount**
- Reverse voltage protection. Hi/Low voltage input protection

## FEATURES & BENEFITS

- **Built-In Deutsch Connector (male mating connector included)**
- **Adjustable Stainless Steel Heavy Duty Shock Absorbing Mount**
- Pressure relief valve
- Reverse voltage protection.

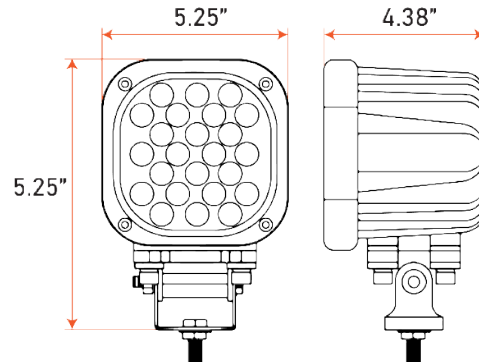
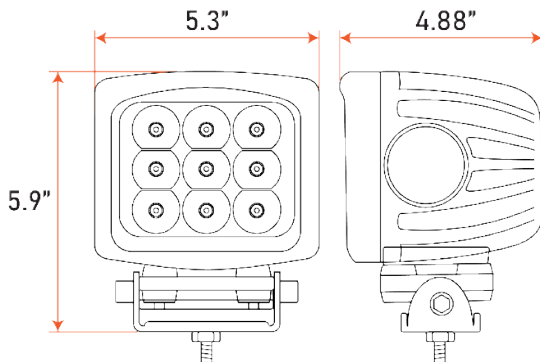

# STANDARD SERIES

Bright & Practical - For Off-Road Applications

LED WORK LAMPS  
LAMPES DE TRAVAIL DEL



| Part No.      | Beam Pattern | Opt. Penetration | Colour |
|---------------|--------------|------------------|--------|
| <b>LW4033</b> | Flood & Spot | 900 ft           | White  |

| Part No.      | Beam Pattern | Opt. Penetration | Colour |
|---------------|--------------|------------------|--------|
| <b>LW4533</b> | Flood & Spot | 600 ft           | White  |

This item will be discontinued soon. LW4033 on pg.29 is direct replacement.

|                  |                            |
|------------------|----------------------------|
| Raw Lumens       | 7080                       |
| Effective Lumens | 5494                       |
| LED              | 28 x 2W                    |
| Voltage          | 10V - 30V                  |
| Amp Draw         | 4.72 @ 12V                 |
| Housing          | High UV Resistant Aluminum |
| Lens             | Polycarbonate              |
| CISPR25 Rating   | Class 3                    |
| IP Rating        | IP69K                      |
| EMC              | Certified                  |
| RoHS             | Certified                  |
| Connection       | 2x Lead Wires              |

|                  |                            |
|------------------|----------------------------|
| Raw Lumens       | 1150                       |
| Effective Lumens | -                          |
| LED              | 10 x 1W                    |
| Voltage          | 9V - 36V                   |
| Amp Draw         | 1.5 @ 12V                  |
| Housing          | High UV Resistant Aluminum |
| Lens             | Polycarbonate              |
| CISPR25 Rating   | -                          |
| IP Rating        | IP67                       |
| EMC              | Certified                  |
| RoHS             | Certified                  |
| Connection       | 2x Lead Wires              |

## FEATURES & BENEFITS

- Curved Lens for wider light spread
- Flood Beam Pattern with Spot Beam Penetration
- Adjustable Stainless Steel Mounting Bracket
- Pressure relief valve
- Reverse voltage protection

## FEATURES & BENEFITS

- Special Focal Design for greater light penetration
- Flood Beam Pattern with Spot Beam Penetration
- Adjustable Stainless Steel Mounting Bracket
- Reverse voltage protection

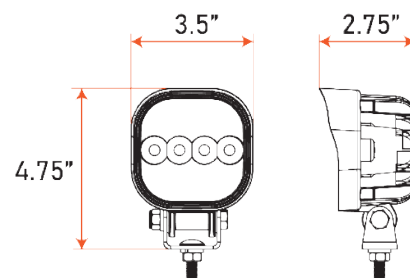
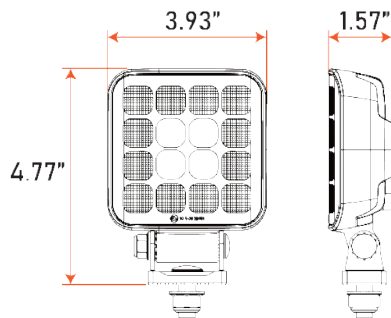

# STANDARD SERIES

Bright & Practical - For Off-Road Applications

A variety of performance LED work lamps. State of the art optic system. High lumen output with low power consumption. Finned aluminum body for heat dissipation. Emits natural white light which reduces eye fatigue.

LW4442



LW4443



| Part No. | Beam Pattern | Opt. Penetration | Colour |
|----------|--------------|------------------|--------|
| LW4442   | Wide Flood   | 350 ft           | White  |
| LW4443   | Spot         | 1100 ft          | White  |

| Part No. | Beam Pattern | Opt. Penetration | Colour |
|----------|--------------|------------------|--------|
| LW4432   | Wide Flood   | 425 ft           | White  |

|                  |                            |
|------------------|----------------------------|
| Raw Lumens       | 4800                       |
| Effective Lumens | -                          |
| LED              | 12 x 5W                    |
| Voltage          | 12V - 60V                  |
| Amp Draw         | 3.5 @ 12V                  |
| Housing          | High UV Resistant Aluminum |
| Lens             | Polycarbonate              |
| CISPR25 Rating   | Class 3                    |
| IP Rating        | IP69K                      |
| EMC              | Certified                  |
| RoHS             | Certified                  |
| Connection       | 2x Lead Wires              |

|                  |                            |
|------------------|----------------------------|
| Raw Lumens       | 4000                       |
| Effective Lumens | -                          |
| LED              | 4 x 10W                    |
| Voltage          | 12V - 30V                  |
| Amp Draw         | 2.5 @ 12V                  |
| Housing          | High UV Resistant Aluminum |
| Lens             | Polycarbonate              |
| CISPR25 Rating   | Class 3                    |
| IP Rating        | IP69K                      |
| EMC              | Certified                  |
| RoHS             | Certified                  |
| Connection       | 2x Lead Wires              |

### FEATURES & BENEFITS

- Built-In Deutsch Connector (male mating connector included)
- Adjustable Stainless Steel Heavy Duty Dual Bolt Mount
- Pressure relief vent
- Reverse voltage protection

### FEATURES & BENEFITS

- Adjustable Stainless Steel Mounting Bracket
- Reverse voltage protection

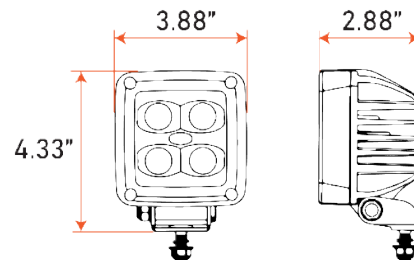
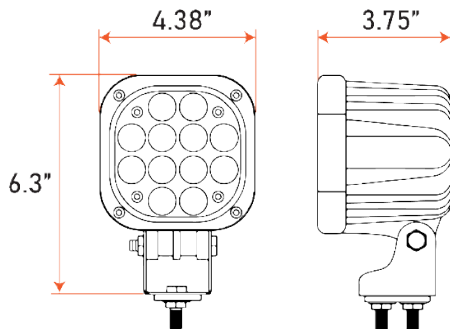

# STANDARD SERIES

Bright & Practical - For Off-Road Applications

LED WORK LAMPS  
LAMPES DE TRAVAIL DEL

LW4422H



LW4422HA



| Part No. | Beam Pattern | Opt. Penetration | Colour |
|----------|--------------|------------------|--------|
| LW4422H  | Flood        | 650 ft           | White  |
| LW4422HA | Flood        | 572 ft           | Amber  |

| Part No. | Beam Pattern | Opt. Penetration | Colour |
|----------|--------------|------------------|--------|
| LW4342AW | Wide Flood   | 370 ft           | White  |
|          |              | 310 ft           | Amber  |

|                  |                            |
|------------------|----------------------------|
| Raw Lumens       | 5400                       |
| Effective Lumens | -                          |
| LED              | 36 x 1.2W                  |
| Voltage          | 9V - 36V                   |
| Amp Draw         | 3.5 @ 12V                  |
| Housing          | High UV Resistant Aluminum |
| Lens             | Tempered Glass             |
| CISPR25 Rating   | Class 5                    |
| IP Rating        | IP69K                      |
| EMC              | Certified                  |
| RoHS             | Certified                  |
| Connection       | 2x Lead Wires              |

|                  |                            |
|------------------|----------------------------|
| Raw Lumens       | 2160                       |
| Effective Lumens | 1500 ~ 1200                |
| LED              | 3 x 9W                     |
| Voltage          | 10V - 60V                  |
| Amp Draw         | 1.7 @ 12V                  |
| Housing          | High UV Resistant Aluminum |
| Lens             | Polycarbonate              |
| CISPR25 Rating   | Class 3                    |
| IP Rating        | IP69K                      |
| EMC              | -                          |
| RoHS             | -                          |
| Connection       | 3x Lead Wires              |

## FEATURES & BENEFITS

- **Electronic Thermal Management** to control lamp temperature
- **Built-In Deutsch Connector** (male mating connector included)
- **Adjustable Stainless Steel Shock Absorbing Mount**
- Pressure relief vent
- Reverse voltage protection. Hi/Low voltage input protection

## FEATURES & BENEFITS

- **Dual Function** (White or Amber)
- **Adjustable Stainless Steel Mounting Bracket**
- Reverse voltage protection

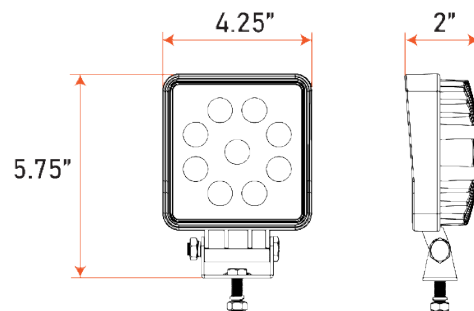
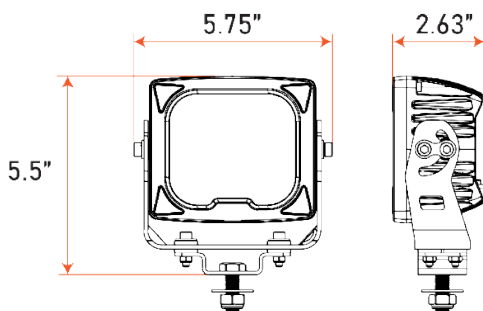

# STANDARD SERIES

Bright & Practical - For Off-Road Applications

A variety of performance LED work lamps. State of the art optic system. High lumen output with low power consumption. Finned aluminum body for heat dissipation. Emits natural white light which reduces eye fatigue.



| Part No.      | Beam Pattern | Opt. Penetration | Colour |
|---------------|--------------|------------------|--------|
| <b>LW4262</b> | Wide Flood   | 500 ft           | White  |

| Part No.      | Beam Pattern | Opt. Penetration | Voltage   |
|---------------|--------------|------------------|-----------|
| <b>LW4232</b> | Wide Flood   | 400 ft           | 10V - 30V |

|                |            |        |                   |
|----------------|------------|--------|-------------------|
| <b>LW4232T</b> | Wide Flood | 400 ft | <b>10V - 110V</b> |
|----------------|------------|--------|-------------------|

|                  |                            |
|------------------|----------------------------|
| Raw Lumens       | 3120                       |
| Effective Lumens | -                          |
| LED              | 16 x 1.5W OSRAM            |
| Voltage          | 10V - 30V                  |
| Amp Draw         | 2.2 @ 12V                  |
| Housing          | High UV Resistant Aluminum |
| Lens             | Polycarbonate              |
| CISPR25 Rating   | -                          |
| IP Rating        | IP69K                      |
| EMC              | Certified                  |
| RoHS             | Certified                  |
| Connection       | 2x Lead Wires              |

|                  |                            |
|------------------|----------------------------|
| Raw Lumens       | 1755                       |
| Effective Lumens | -                          |
| LED              | 9 x 1.5W OSRAM             |
| Colour           | White                      |
| Amp Draw         | 1.4 @ 12V                  |
| Housing          | High UV Resistant Aluminum |
| Lens             | Polycarbonate              |
| CISPR25 Rating   | -                          |
| IP Rating        | IP69K                      |
| EMC              | Certified                  |
| RoHS             | Certified                  |
| Connection       | 2x Lead Wires              |

### FEATURES & BENEFITS

- Adjustable Stainless Steel Mounting Bracket
- Reverse voltage protection

### FEATURES & BENEFITS

- Adjustable Stainless Steel Mounting Bracket
- Reverse voltage protection

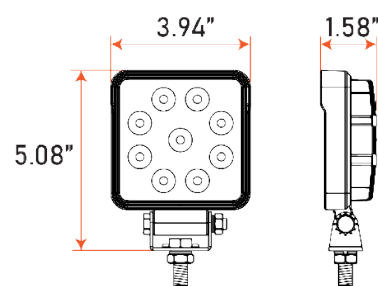
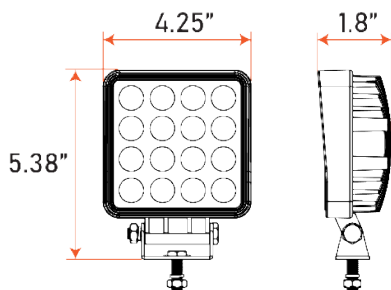

# STANDARD SERIES

Bright & Practical - For Off-Road Applications

LED WORK LAMPS  
LAMPES DE TRAVAIL DEL



| Part No. | Beam Pattern | Opt. Penetration | Colour |
|----------|--------------|------------------|--------|
| LW2642   | Flood        | 800 ft           | White  |
| LW2643   | Spot         | 2050 ft          | White  |

| Part No. | Beam Pattern | Opt. Penetration | Colour |
|----------|--------------|------------------|--------|
| LW6042   | Flood        | 500 ft           | White  |

|                  |                            |
|------------------|----------------------------|
| Raw Lumens       | 6600                       |
| Effective Lumens | -                          |
| LED              | 6 x 10W                    |
| Voltage          | 12V - 60V                  |
| Amp Draw         | 3.9 @ 12V                  |
| Housing          | High UV Resistant Aluminum |
| Lens             | Polycarbonate              |
| CISPR25 Rating   | Class 4                    |
| IP Rating        | IP69K                      |
| EMC              | Certified                  |
| RoHS             | Certified                  |
| Connection       | 2x Lead Wires              |

|                  |                            |
|------------------|----------------------------|
| Raw Lumens       | 2900                       |
| Effective Lumens | -                          |
| LED              | 15 x 1.5W OSRAM            |
| Voltage          | 10V - 30V                  |
| Amp Draw         | 2.1 @ 12V                  |
| Housing          | High UV Resistant Aluminum |
| Lens             | Polycarbonate              |
| CISPR25 Rating   | -                          |
| IP Rating        | IP69K                      |
| EMC              | Certified                  |
| RoHS             | Certified                  |
| Connection       | 2x Lead Wires              |

## FEATURES & BENEFITS

- Electronic Thermal Management to control lamp temperature
- Deutsch Connector (male mating connector included)
- Adjustable Stainless Steel Heavy Duty Mounting Bracket
- Pressure Relief Vent
- Reverse voltage protection. Hi/Low voltage input protection

## FEATURES & BENEFITS

- Adjustable Stainless Steel Mounting Bracket
- Reverse voltage protection. Hi/Low voltage input protection

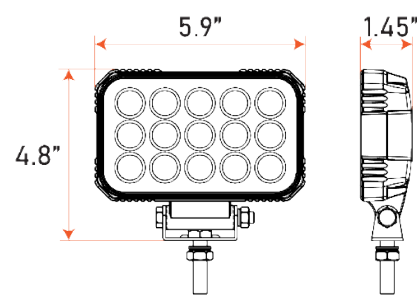
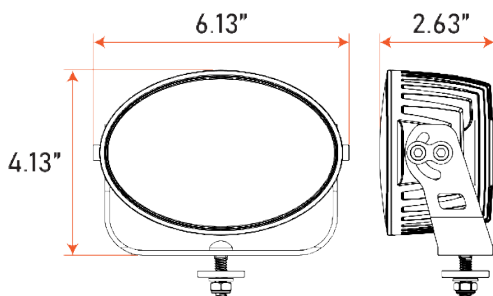

# SUPER WIDE SERIES

See Everything - For Off-Road Applications

Super wide series work lamps provide the widest view possible in a single lamp. Great for covering proximity based work environments like agriculture or construction. State of the art curved optic system. High lumen output with low power consumption. Finned aluminum body for heat dissipation. Emits natural white light which reduces eye fatigue.



| Part No.      | Beam Pattern     | Opt. Penetration | Colour |
|---------------|------------------|------------------|--------|
| <b>LW5032</b> | Super Wide Flood | 500 ft           | White  |

| Part No.      | Beam Pattern     | Opt. Penetration | Colour |
|---------------|------------------|------------------|--------|
| <b>LW5022</b> | Super Wide Flood | 350 ft           | White  |

|                  |                            |
|------------------|----------------------------|
| Raw Lumens       | 5600                       |
| Effective Lumens | 3300                       |
| LED              | 6 x 10W                    |
| Voltage          | 9V - 36V                   |
| Amp Draw         | 4.2 @ 12V                  |
| Housing          | High UV Resistant Aluminum |
| Lens             | Polycarbonate              |
| CISPR25 Rating   | Class 5                    |
| IP Rating        | IP69K                      |
| EMC              | Certified                  |
| RoHS             | Certified                  |
| Connection       | 2x Lead Wires              |

|                  |                            |
|------------------|----------------------------|
| Raw Lumens       | 3200                       |
| Effective Lumens | 2500                       |
| LED              | 3 x 10W                    |
| Voltage          | 9V - 36V                   |
| Amp Draw         | 2.3 @ 12V                  |
| Housing          | High UV Resistant Aluminum |
| Lens             | Polycarbonate              |
| CISPR25 Rating   | Class 5                    |
| IP Rating        | IP68                       |
| EMC              | Certified                  |
| RoHS             | Certified                  |
| Connection       | 2x Lead Wires              |

## FEATURES & BENEFITS

- Curved Lens for a Wider Light Spread
- Electronic Thermal Management to control lamp temperature
- Built-In Deutsch Connector (male mating connector included)
- Adjustable Stainless Steel Mounting Bracket
- Pressure relief vent
- Reverse voltage protection. Hi/Low voltage input protection

## FEATURES & BENEFITS

- Curved Lens for a Wider Light Spread
- Electronic Thermal Management to control lamp temperature
- Deutsch Connector (male mating connector included)
- Adjustable Stainless Steel Mounting Bracket
- Reverse voltage protection. Hi/Low voltage input protection

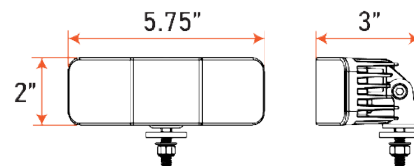
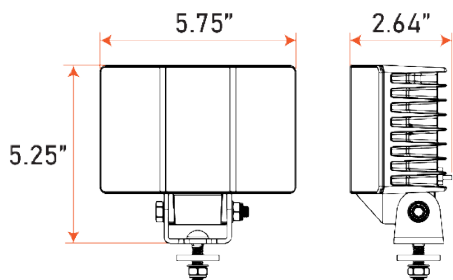



# SUPER WIDE SERIES

See Everything - For Off-Road Applications



| Part No.      | Beam Pattern      | Opt. Penetration | Colour |
|---------------|-------------------|------------------|--------|
| <b>LW3423</b> | Wide Flood + Spot | 1450 ft          | Clear  |

|                  |                                       |
|------------------|---------------------------------------|
| Raw Lumens       | 3540                                  |
| Effective Lumens | -                                     |
| LED              | spot: (4 x 5W) + wide flood: (6 x 1W) |
| Voltage          | 10V - 30V                             |
| Amp Draw         | 2.2 @ 12V                             |
| Housing          | High UV Resistant Aluminum            |
| Lens             | Polycarbonate                         |
| CISPR25 Rating   | -                                     |
| IP Rating        | IP69K                                 |
| EMC              | Certified                             |
| RoHS             | Certified                             |
| Connection       | 2x Lead Wires                         |

## FEATURES & BENEFITS

- **Side Shooters** add the benefit of wider close range light spread
- **Flood Beam Pattern with Spot Beam Penetration**
- **Adjustable Stainless Steel Mounting Bracket**
- Pressure relief vent
- Reverse voltage protection

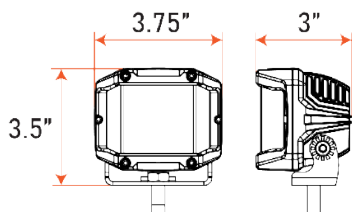

## Tips to MAXIMIZE the life of your lamps

**1** Keep lamps clean, free of mud and dirt. The lamps are designed to dissipate heat. If the lamp is covered with mud, the mud acts as an insulator, the lamps will heat up, and the LED diodes will dim. It will shorten the life of the LED diodes.

**2** Polycarbonate lens are unbreakable under normal conditions. However, polycarbonate is very soft and flexible to absorb impact. Use of harsh chemicals for cleaning the lens is not recommended. Use a mild detergent solution only and soft wipes to avoid scratches.

**3** Avoid electrical shorts. Voltage spikes can destroy LED diodes. It is recommended that connections be insulated to avoid shorting between positive and negative terminals.

**4** IP ratings are for the lamps only. The use of waterproof connections are required to maintain a waterproof installation.

**5** Lamps without hi/low voltage protection can be damaged if they are connected directly to a battery or to a system that does not have a voltage regulator. If there is no voltage regulator, lamps should be disconnected if you are jump starting or charging a system. Also, several hours of using lamps at lower than stated voltage can harm the LED diodes. If lamps fail to operate, please check voltage. If voltage is low, disconnect lamps until the system is charged to standard voltage.

**6** Lamps should be fused to protect circuits.

# SURFACE MOUNT SERIES

Anywhere, Anytime Light - For Off-Road Applications

Work lamps that you can practically mount on any flat surface without the use of brackets. State of the art optic system. High lumen output with low power consumption. Finned aluminum body for heat dissipation. Emits natural white light which reduces eye fatigue.



| Part No.      | Beam Pattern | Opt. Penetration | Colour |
|---------------|--------------|------------------|--------|
| <b>LW5015</b> | Wide Flood   | 450 ft           | White  |

| Part No.      | Beam Pattern | Opt. Penetration | Colour |
|---------------|--------------|------------------|--------|
| <b>LW2017</b> | Wide Flood   | 110 ft           | White  |

|                  |                            |
|------------------|----------------------------|
| Raw Lumens       | 2800                       |
| Effective Lumens | 2200                       |
| LED              | 4 x 6W                     |
| Voltage          | 9V - 36V                   |
| Amp Draw         | 1.6 @ 12V                  |
| Housing          | High UV Resistant Aluminum |
| Lens             | Polycarbonate              |
| CISPR25 Rating   | Class 3                    |
| IP Rating        | -                          |
| EMC              | Certified                  |
| RoHS             | Certified                  |
| Connection       | 2x Lead Wires              |

|                  |                            |
|------------------|----------------------------|
| Raw Lumens       | 945                        |
| Effective Lumens | 724                        |
| LED              | 6 x 1.5W                   |
| Voltage          | 10V - 30V                  |
| Amp Draw         | 0.6 @ 12V                  |
| Housing          | High UV Resistant Aluminum |
| Lens             | Polycarbonate              |
| CISPR25 Rating   | -                          |
| IP Rating        | IP68                       |
| EMC              | Certified                  |
| RoHS             | Certified                  |
| Connection       | 2x Lead Wires              |

## FEATURES & BENEFITS

- **Electronic Thermal Management** to control lamp temperature
- **Sealed Deutsch Connectors** (male mating connector included)
- **Surface Mount @ 35° angle**
- **Rubber Mount @ 48° angle**
- Pressure relief valve
- Reverse voltage protection

## FEATURES & BENEFITS

- **Designed for Compact Spaces**
- **Super Wide Beam** for it's mini size
- **Rubber Mounting Pad**
- Reverse voltage protection

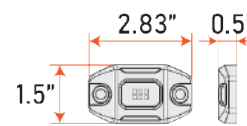
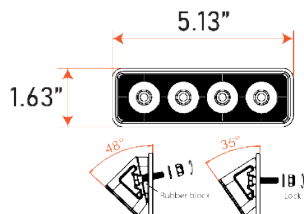

# ECON SERIES

Basic Needs, Entry Level & Cost Effective - For Off-Road Applications

The best bang for your buck. Highly effective lamps designed specifically with a cost to wattage usage in mind. High lumen output with low power consumption. Finned aluminum body for heat dissipation. Emits natural white light which reduces eye fatigue.



| Part No.      | Beam Pattern | Opt. Penetration | Colour |
|---------------|--------------|------------------|--------|
| <b>LW4322</b> | Wide Flood   | 480 ft           | White  |

| Part No.      | Beam Pattern | Opt. Penetration | Colour |
|---------------|--------------|------------------|--------|
| <b>LW4222</b> | Wide Flood   | 500 ft           | White  |

|                  |                            |
|------------------|----------------------------|
| Raw Lumens       | 1980                       |
| Effective Lumens | -                          |
| LED              | 15 x 1.5W OSRAM            |
| Voltage          | 12V - 30V                  |
| Amp Draw         | 1.9 @ 12V                  |
| Housing          | High UV Resistant Aluminum |
| Lens             | Polycarbonate              |
| CISPR25 Rating   | -                          |
| IP Rating        | IP69K                      |
| EMC              | Certified                  |
| RoHS             | Certified                  |
| Connection       | 2x Lead Wires              |

|                  |                            |
|------------------|----------------------------|
| Raw Lumens       | 1755                       |
| Effective Lumens | -                          |
| LED              | 9 x 1.5W OSRAM             |
| Voltage          | 10V - 30V                  |
| Amp Draw         | 1.2 @ 12V                  |
| Housing          | High UV Resistant Aluminum |
| Lens             | Polycarbonate              |
| CISPR25 Rating   | -                          |
| IP Rating        | IP69K                      |
| EMC              | Certified                  |
| RoHS             | Certified                  |
| Connection       | 2x Lead Wires              |

### FEATURES & BENEFITS

- Adjustable Stainless Steel Mounting Bracket
- Reverse voltage protection

### FEATURES & BENEFITS

- Adjustable Stainless Steel Mounting Bracket
- Reverse voltage protection

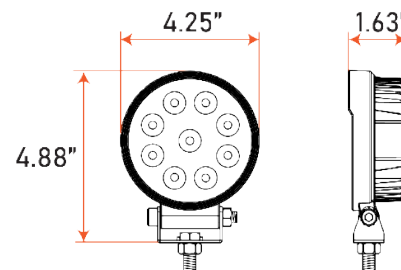
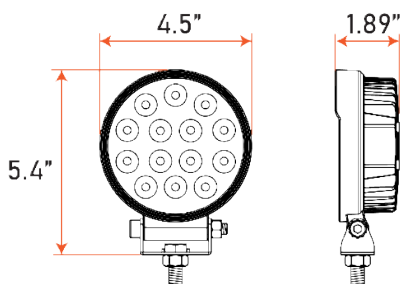

# ECON SERIES

Basic Needs, Entry Level & Cost Effective - For Off-Road Applications

The best bang for your buck. Highly effective lamps designed specifically with a cost to wattage usage in mind. High lumen output with low power consumption. Finned aluminum body for heat dissipation. Emits natural white light which reduces eye fatigue.

LW4602



LW4603



LW0220



LW0220A



| Part No. | Beam Pattern | Opt. Penetration | Colour |
|----------|--------------|------------------|--------|
| LW4602   | Flood        | 200 ft           | White  |
| LW4603   | Spot         | 300 ft           | White  |

|                  |                            |
|------------------|----------------------------|
| Raw Lumens       | 1260                       |
| Effective Lumens | -                          |
| LED              | 6 x 3W                     |
| Voltage          | 12V - 30V                  |
| Amp Draw         | 1.4 @ 12V                  |
| Housing          | High UV Resistant Aluminum |
| Lens             | Polycarbonate              |
| CISPR25 Rating   | -                          |
| IP Rating        | IP69K                      |
| EMC              | Certified                  |
| RoHS             | Certified                  |
| Connection       | 2x Lead Wires              |

## FEATURES & BENEFITS

- Adjustable Stainless Steel Mounting Bracket
- Reverse voltage protection. Hi/Low voltage input protection

| Part No. | Beam Pattern | Opt. Penetration | Colour |
|----------|--------------|------------------|--------|
| LW0220   | Flood        | 270 ft           | White  |
| LW0220A  | Flood        | 230 ft           | Amber  |

|                  |                            |
|------------------|----------------------------|
| Raw Lumens       | 1000                       |
| Effective Lumens | 850 ~ 595                  |
| LED              | 4 x 3W                     |
| Voltage          | 9V - 36V                   |
| Amp Draw         | 1.0 @ 12V                  |
| Housing          | High UV Resistant Aluminum |
| Lens             | Polycarbonate              |
| CISPR25 Rating   | -                          |
| IP Rating        | IP68                       |
| EMC              | Certified                  |
| RoHS             | Certified                  |
| Connection       | 2x Lead Wires              |

## FEATURES & BENEFITS

- Electronic Thermal Management to control lamp temperature
- Adjustable Stainless Steel Mounting Bracket
- Reverse voltage protection

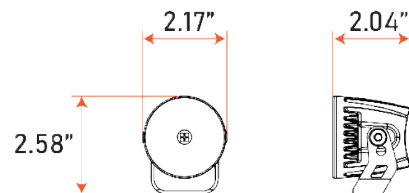
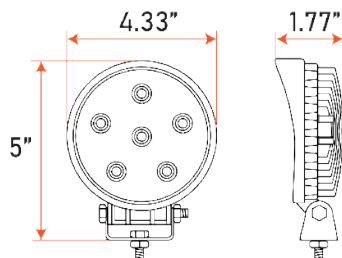

# ECON SERIES

Basic Needs, Entry Level & Cost Effective - For Off-Road Applications

LW0302S-F



LW0303S-F



| Part No.  | Beam Pattern | Opt. Penetration | Colour |
|-----------|--------------|------------------|--------|
| LW0302S-F | Wide Flood   | 470 ft           | White  |
| LW0303S-F | Spot         | 1460 ft          | White  |

|                  |                            |
|------------------|----------------------------|
| Raw Lumens       | 1080                       |
| Effective Lumens | -                          |
| LED              | 4 x 3W OSRAM               |
| Voltage          | 12V - 30V                  |
| Amp Draw         | 0.9 @ 12V                  |
| Housing          | High UV Resistant Aluminum |
| Lens             | Polycarbonate              |
| CISPR25 Rating   | -                          |
| IP Rating        | IP69K                      |
| EMC              | Certified                  |
| RoHS             | Certified                  |
| Connection       | 2x Lead Wires              |

#### FEATURES & BENEFITS

- **Flush Mount Style (mounts into the surface)**
- Reverse voltage protection. Hi/Low voltage input protection
- Mounting: 4 holes @ 4" centres by 1.25" centres

| Part No. | Beam Pattern | Opt. Penetration | Colour |
|----------|--------------|------------------|--------|
| LW5040   | Flood        | 400 ft           | White  |

|                  |                            |
|------------------|----------------------------|
| Raw Lumens       | 840                        |
| Effective Lumens | -                          |
| LED              | 8 x 1W                     |
| Voltage          | 9V - 36V                   |
| Amp Draw         | 0.8 @ 12V                  |
| Housing          | High UV Resistant Aluminum |
| Lens             | Polycarbonate              |
| CISPR25 Rating   | -                          |
| IP Rating        | IP67                       |
| EMC              | Certified                  |
| RoHS             | Certified                  |
| Connection       | 2x Lead Wires              |

#### FEATURES & BENEFITS

- **Adjustable Stainless Steel Mounting Bracket**
- Reverse voltage protection

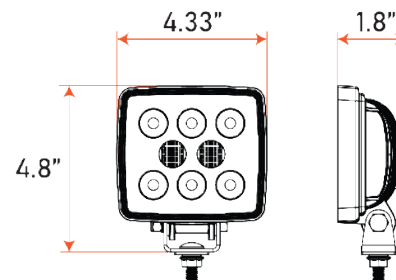
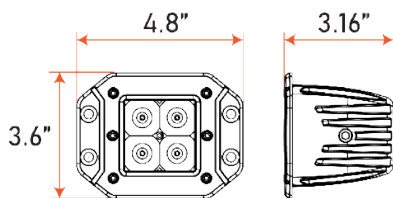

# LOW PROFILE SERIES

## Slim & Compact - For Off-Road Applications

Work lamps designed to fit in narrow and tight spaces. High lumen output with low power consumption. Finned aluminum body for heat dissipation. Emits natural white light which reduces eye fatigue.



| Part No. | Lumens | Opt. Penetration | LED      |
|----------|--------|------------------|----------|
| LW6007   | 1170   | 500 ft           | 6 x 3W   |
| LW6008   | 1260   | 450 ft           | 6 x 1.5W |
| LW6009   | 1620   | 1450 ft          | 6 x 3W   |

| Part No. | Lumens | Opt. Penetration | Colour         |
|----------|--------|------------------|----------------|
| LW6097AW | 2800   | 330 ft           | White Flood    |
|          |        | 210 ft           | Amber Flashing |

|                |                            |
|----------------|----------------------------|
| Beam Pattern   | Flood Centre Spot          |
| Colour         | White                      |
| Voltage        | 12V - 30V                  |
| Amp Draw       | 1.4 @ 12V                  |
| Housing        | High UV Resistant Aluminum |
| Lens           | Polycarbonate              |
| CISPR25 Rating | -                          |
| IP Rating      | IP69K                      |
| EMC            | Certified                  |
| RoHS           | Certified                  |
| Connection     | 2x Lead Wires              |

|                |   |
|----------------|---|
| Beam Pattern   | Flood                                     |
| LED            | Flood: (9 x 1.5W) / Amber Flash: (9 x 1W) |
| Voltage        | 10V - 30V                                 |
| Amp Draw       | 1.25 @ 12V                                |
| Housing        | High UV Resistant Aluminum                |
| Lens           | Polycarbonate                             |
| CISPR25 Rating | -   |
| IP Rating      | IP69K                                     |
| EMC            | Certified                                 |
| RoHS           | Certified                                 |
| Connection     | 3x Lead Wires                             |

### FEATURES & BENEFITS

- Adjustable Stainless Steel Mounting Bracket
- Reverse voltage protection. Hi/Low voltage input protection

### FEATURES & BENEFITS

- Dual Function (White Flood or Amber Flasher)
- Adjustable Stainless Steel Mounting Bracket
- Reverse voltage protection

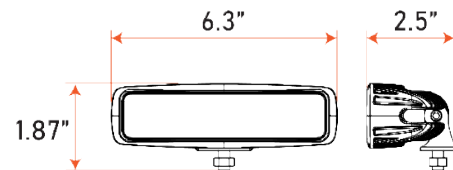
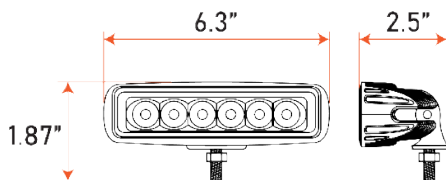



# NEW PRODUCTS

The Most Powerful Low Profile Lamp meets The Most Powerful Search Lamp - For Off-Road Applications  
 The most durable and powerful search lamp you can possibly find. We gave up compact size for Heavy Duty & maximized the light output.  
 Finned aluminum body for heat dissipation. Emits natural white light which reduces eye fatigue.

LED WORK LAMPS  
 LAMPES DE TRAVAIL DEL



| Part No.        | Beam Pattern | Opt. Penetration | Colour |
|-----------------|--------------|------------------|--------|
| <b>LW3328</b>   | Spot         | 1230 ft          | Clear  |
| <b>LW3329</b>   | Flood        | 350 ft           | Clear  |
| <b>LW3320AF</b> | Fog          | 755 ft           | Amber  |

| Part No.       | Beam Pattern | Opt. Penetration | Colour |
|----------------|--------------|------------------|--------|
| <b>LED7802</b> | Flood        | 800 ft           | White  |
| <b>LED7803</b> | Spot         | 2050 ft          | White  |

|                  |                            |
|------------------|----------------------------|
| Raw Lumens       | 2800                       |
| Effective Lumens | 2300                       |
| LED              | 2 x 15W                    |
| Voltage          | 9V - 36V                   |
| Amp Draw         | 2.6 @ 12V                  |
| Housing          | High UV Resistant Aluminum |
| Lens             | Polycarbonate              |
| CISPR25 Rating   | Class 3                    |
| IP Rating        | IP69K                      |
| EMC              | Certified                  |
| RoHS             | Certified                  |
| Connection       | 2x Lead Wires              |

|                  |                 |
|------------------|-----------------|
| Raw Lumens       | 7800            |
| Effective Lumens | 4400            |
| LED              | 16 x 5W         |
| Voltage          | 10V - 30V       |
| Amp Draw         | 6.1 @ 12V       |
| Housing          | Magnesium Alloy |
| Lens             | Polycarbonate   |
| CISPR25 Rating   | -               |
| IP Rating        | IP65            |
| EMC              | -               |
| RoHS             | Certified       |
| Connection       | 2x Lead Wires   |

### FEATURES & BENEFITS

- **Electronic Thermal Management**
- **Adjustable Stainless Steel Mounting Bracket**
- Reverse voltage protection. Hi/Low voltage input protection

### FEATURES & BENEFITS

- **Remote Control Distance: 30m ~ 40m**
- **110° vertical rotation & 360° horizontal rotation**
- **Magnetic Base Mount or Surface Bolt Mount with Rubber Base**
- Remote Control Pairing Capability (2x Remote Controls included)

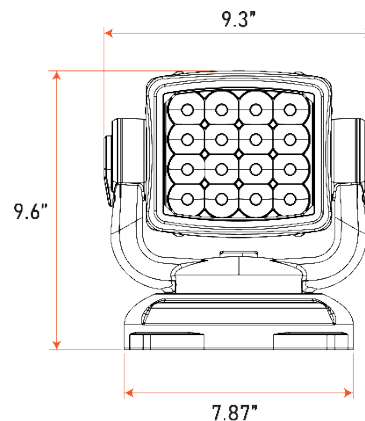
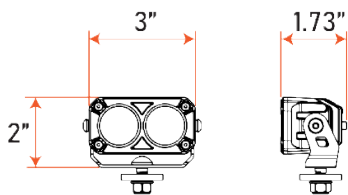

# SEALED BEAM SERIES - PAR36

Designed for OEM Par 36 Lamp Housing - For Off-Road Applications

Lamps designed to fit perfectly into PAR36 housings. High lumen output with low power consumption. Finned aluminum body for heat dissipation. Emits natural white light which reduces eye fatigue.



| Part No.       | Beam Pattern                    | Opt. Penetration         | Colour |
|----------------|---------------------------------|--------------------------|--------|
| <b>LW44032</b> | Hi (Flood + Spot)<br>Lo (Flood) | Hi: 800 ft<br>Lo: 500 ft | White  |

| Part No.      | Beam Pattern | Opt. Penetration | Colour |
|---------------|--------------|------------------|--------|
| <b>LW4402</b> | Flood        | 240 ft           | White  |

|                  |                        |
|------------------|------------------------|
| Raw Lumens       | Hi: 2080 / Lo: 1040    |
| Effective Lumens | Hi: 1600 / Lo: 800     |
| LED              | 8 x 3W                 |
| Voltage          | 10V - 30V              |
| Amp Draw         | 1.5 @ 12V              |
| Housing          | Powder Coated Aluminum |
| Lens             | Polycarbonate          |
| CISPR25 Rating   | Class 3                |
| IP Rating        | IP68                   |
| EMC              | -                      |
| RoHS             | Certified              |
| Connection       | 3x Lead Wires          |

|                  |                        |
|------------------|------------------------|
| Raw Lumens       | 800                    |
| Effective Lumens | -                      |
| LED              | 1 x 10W                |
| Voltage          | 9V - 36V               |
| Amp Draw         | 1.2 @ 12V              |
| Housing          | Powder Coated Aluminum |
| Lens             | Polycarbonate          |
| CISPR25 Rating   | -                      |
| IP Rating        | -                      |
| EMC              | Certified              |
| RoHS             | -                      |
| Connection       | 2x Lead Wires          |

#### FEATURES & BENEFITS

- Fits PAR36 Housing/Applications
- Reverse voltage protection

#### FEATURES & BENEFITS

- Fits PAR36 Housing/Applications
- Reverse voltage protection

COMPLETE KITS (For Open Face Retail Box, add the suffix "X")

|                |  |
|----------------|--|
| <b>LW54032</b> | Lamp with steel reinforced rubber-like resin housing |
|----------------|--|

COMPLETE KITS (For Open Face Retail Box, add the suffix "X")

|                 |  |
|-----------------|--|
| <b>LW4402K</b>  | Lamp with mounting bracket                           |
| <b>LW5402</b>   | Lamp with steel reinforced rubber-like resin housing |
| <b>LW5402-M</b> | LW5402 with magnetic base & 13ft cigarette adaptor   |



# SEALED BEAM SERIES - PAR36

Designed for OEM Par 36 Lamp Housing - For Off-Road Applications



| Part No.      | Beam Pattern | Opt. Penetration | Colour |
|---------------|--------------|------------------|--------|
| <b>LW4400</b> | Combo        | 300 ft           | White  |

| Part No.       | Beam Pattern | Opt. Penetration | Colour |
|----------------|--------------|------------------|--------|
| <b>LED4411</b> | Flood        | 460 ft           | White  |

|                  |                        |
|------------------|------------------------|
| Raw Lumens       | 1040                   |
| Effective Lumens | -                      |
| LED              | 8 x 3W                 |
| Voltage          | 9V - 36V               |
| Amp Draw         | 1.0 @ 12V              |
| Housing          | Powder Coated Aluminum |
| Lens             | Polycarbonate          |
| CISPR25 Rating   | -                      |
| IP Rating        | IP67                   |
| EMC              | Certified              |
| RoHS             | Certified              |
| Connection       | 2x Lead Wires          |

|                  |                        |
|------------------|------------------------|
| Raw Lumens       | 400                    |
| Effective Lumens | -                      |
| LED              | 4 x 1.5W OSRAM         |
| Voltage          | 9V - 32V               |
| Amp Draw         | 0.45 @ 12V             |
| Housing          | Powder Coated Aluminum |
| Lens             | Tempered Glass         |
| CISPR25 Rating   | -                      |
| IP Rating        | -                      |
| EMC              | -                      |
| RoHS             | -                      |
| Connection       | 2x Studs               |

## FEATURES & BENEFITS

- Fits PAR36 Housing/Applications
- Reverse voltage protection

## FEATURES & BENEFITS

- Fits PAR36 Housing/Applications
- Reverse voltage protection

COMPLETE KITS (For Open Face Retail Box, add the suffix "X")

|                 |  |
|-----------------|--|
| <b>LW4400K</b>  | Lamp with mounting bracket                           |
| <b>LW5400</b>   | Lamp with steel reinforced rubber-like resin housing |
| <b>LW5400-M</b> | LW5402 with magnetic base & 13ft cigarette adaptor   |

COMPLETE KITS (For Open Face Retail Box, add the suffix "X")

|                 |  |
|-----------------|--|
| <b>LW4411</b>   | Lamp with steel reinforced rubber-like resin housing |
| <b>LW4411-M</b> | LW5402 with magnetic base & 13ft cigarette adaptor   |



# BATTERY OPERATED LED LAMPS - PORTABLE

Designed for ease of use - Compatible with DeWalt & Milwaukee

Finned aluminum body for heat dissipation. These are coloured lamps.



| Part No.       | Beam Pattern | Opt. Penetration | Colour |
|----------------|--------------|------------------|--------|
| <b>LWR4550</b> | Wide Flood   | 750 ft           | White  |

| Part No.       | Beam Pattern | Opt. Penetration | Colour |
|----------------|--------------|------------------|--------|
| <b>LWR4520</b> | Wide Flood   | 350 ft           | White  |

|                  |                                |
|------------------|--------------------------------|
| Raw Lumens       | 5000                           |
| Effective Lumens | -                              |
| LED              | 100 x 0.5W                     |
| Voltage          | 20V MAX                        |
| Housing          | High UV Resistant Aluminum     |
| Lens             | Polycarbonate                  |
| CISPR25 Rating   | -                              |
| IP Rating        | -                              |
| EMC              | Certified                      |
| RoHS             | Certified                      |
| Battery          | Compatible with DeWalt Battery |
| Dimensions       | 8.66" L x 13.58" H x 2.95" D   |

|                  |                                |
|------------------|--------------------------------|
| Raw Lumens       | 1800                           |
| Effective Lumens | -                              |
| LED              | 60 x 0.33W                     |
| Voltage          | 20V MAX                        |
| Housing          | High UV Resistant Aluminum     |
| Lens             | Polycarbonate                  |
| CISPR25 Rating   | -                              |
| IP Rating        | -                              |
| EMC              | Certified                      |
| RoHS             | Certified                      |
| Battery          | Compatible with DeWalt Battery |
| Dimensions       | 6.38" L x 11" H x 2.24" D      |

## FEATURES & BENEFITS

- **BATTERIES NOT INCLUDED**
- 120° vertical rotation & 360° horizontal rotation
- 3 Brightness Settings

## FEATURES & BENEFITS

- **BATTERIES NOT INCLUDED**
- 120° vertical rotation & 360° horizontal rotation
- 3 Brightness Settings

## ACCESSORIES

|                |  |
|----------------|--|
| <b>LWS3310</b> | Adaptor - Converts Milwaukee to Dewalt |
|----------------|--|

## ACCESSORIES

|                |  |
|----------------|--|
| <b>LWS3310</b> | Adaptor - Converts Milwaukee to Dewalt |
|----------------|--|



**Fits up to 2  
DeWalt  
Battery Pack**



# BATTERY OPERATED LED LAMPS - HANDHELD

Designed for ease of use - Compatible with DeWalt & Milwaukee

Aluminum body for heat dissipation. These are coloured lamps.

LWR5313-DW



LWR5313-MW



| Part No.   | Beam Pattern | Opt. Penetration | Battery   |
|------------|--------------|------------------|-----------|
| LWR5313-DW | Combo        | 1325 ft          | DeWalt    |
| LWR5313-MW | Combo        | 1325 ft          | Milwaukee |

|                  |                          |
|------------------|--------------------------|
| Raw Lumens       | 2000                     |
| Effective Lumens | -                        |
| LED              | SPOT: 14 / FLOOD: 22     |
| Voltage          | 20V MAX                  |
| Housing          | Aluminum                 |
| Lens             | Polycarbonate            |
| CISPR25 Rating   | -                        |
| IP Rating        | -                        |
| EMC              | -                        |
| RoHS             | Certified                |
| Colour           | White                    |
| Dimensions       | 5.47" L x 7.75" H x 5" D |

## FEATURES & BENEFITS

- **BATTERIES NOT INCLUDED**
- **90° vertical rotation. Can be used like a Flashlight**
- 2 Beam Pattern Settings & 2 Brightness Settings

## ACCESSORIES

|         |  |
|---------|--|
| LWS3310 | Adaptor - Converts Milwaukee to Dewalt |
|---------|--|

Converts into  
a handheld  
Flashlight



## Choosing the RIGHT Lamp for the Job

### There's more to choosing than just lumens

Focal design is equally important for aiming, shaping and dispersing light.

Lenses and reflectors create the beam patterns necessary for their intended use and to enhance performance.

Housing designs combine functionality and durability with the stylish profiles demanded by the off-road and light truck accessory markets.

### LED lamps come in four basic beam patterns

**1 Spot beam** which stays tightly focused for long distances.

**2 Flood beam** which spreads the available light across a wider path.

**3 Wide flood beam** which broadly covers the immediate area.

**4 Flood/Spot combination beam** that has both spot and flood capabilities.

## Care Tips

Finned aluminum body is a thermal management system. **All fins and lamp body should be kept clean to dissipate heat.** Mud and dirt accumulated on fins & lamp body will act as insulation to overheat the lamp and will be overheating the LEDs.

**Lamp failure due to overheat will not be covered by warranty.**

# LED SPECIALTY LAMPS

Designed for Forklift or any applications that require Proximity Caution Lights - For Offroad Applications

Finned aluminum body for heat dissipation. These are coloured lamps.

LW1123



LW1133



| Part No. | Beam Pattern | Opt. Penetration | Colour |
|----------|--------------|------------------|--------|
| LW1123   | ARC          | 45 ft            | Red    |
| LW1133   | LINE         | 47 ft            | Red    |

| Part No.  | Beam Pattern | Opt. Penetration | Colour |
|-----------|--------------|------------------|--------|
| LW3513-BU | Spot         | 65 ft            | Blue   |

|                  |                            |
|------------------|----------------------------|
| Raw Lumens       | 100                        |
| Effective Lumens | 60                         |
| LED              | 2 x 3W                     |
| Voltage          | 12V - 80V                  |
| Amp Draw         | 1.72 @ 12V                 |
| Housing          | High UV Resistant Aluminum |
| Lens             | Polycarbonate              |
| CISPR25 Rating   | -                          |
| IP Rating        | IP67                       |
| EMC              | Certified                  |
| RoHS             | -                          |
| Connection       | 2x Lead Wires              |

|                  |                            |
|------------------|----------------------------|
| Raw Lumens       | 540                        |
| Effective Lumens | -                          |
| LED              | 2 x 6W                     |
| Voltage          | 10V - 80V                  |
| Amp Draw         | 0.26 @ 12V                 |
| Housing          | High UV Resistant Aluminum |
| Lens             | Polycarbonate              |
| CISPR25 Rating   | -                          |
| IP Rating        | IP69K                      |
| EMC              | Certified                  |
| RoHS             | Certified                  |
| Connection       | 2x Lead Wires              |

## FEATURES & BENEFITS

- Adjustable Iron Mounting Bracket
- Reverse voltage protection.

## FEATURES & BENEFITS

- Adjustable Stainless Steel Mounting Bracket
- Reverse voltage protection. Hi/Low voltage input protection

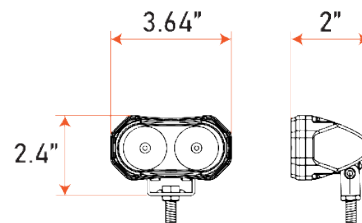
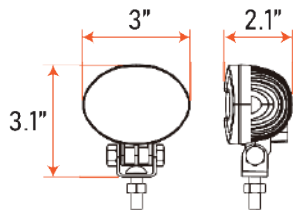
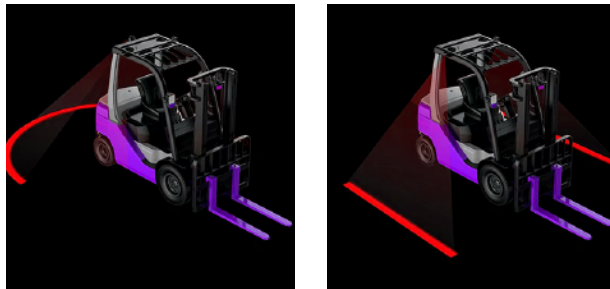



# LED SPECIALTY LAMPS

Personalize your ride - For Off-Road Applications

Aluminum body for heat dissipation. These are coloured lamps.

LED WORK LAMPS  
LAMPES DE TRAVAIL DEL



| Part No.       | Beam Pattern | Opt. Penetration | Colour |
|----------------|--------------|------------------|--------|
| <b>E-0303B</b> | Combo        | 165 ft           | Blue   |

| Part No.          | Beam Pattern | Opt. Penetration | Colour |
|-------------------|--------------|------------------|--------|
| <b>RGB2017-4K</b> | Wide Flood   | 110 ft           | RGB    |

|                |                               |
|----------------|-------------------------------|
| Raw Lumens     | 1540                          |
| Flash Patterns | 19 Patterns                   |
| LED            | 4 x 1W                        |
| Voltage        | 12V - 30V                     |
| Amp Draw       | 0.6 @ 12V                     |
| Housing        | High UV Resistant Aluminum    |
| Lens           | Plastic                       |
| SAE            | SAE J595 Class 1 on 4 Flashes |
| IP Rating      | IP68                          |
| EMC            | Certified                     |
| RoHS           | -                             |
| Connection     | 4x Lead Wires                 |

|                  |                                       |
|------------------|---------------------------------------|
| Raw Lumens       | 945                                   |
| Effective Lumens | 724                                   |
| LED              | 6 x 2W                                |
| Voltage          | 10V - 30V                             |
| Amp Draw         | 0.16 @ 12V                            |
| Housing          | High UV Resistant Aluminum            |
| Lens             | Polycarbonate                         |
| CISPR25 Rating   | -                                     |
| IP Rating        | IP69K                                 |
| EMC              | Certified                             |
| RoHS             | Certified                             |
| Connection       | Waterproof Connectors & 2x Lead Wires |

## FEATURES & BENEFITS

- **Steady Blue Light Function on separate wire**
- **Synchronizable up to 15 units to flash alternating/simultaneous**
- **Adjustable Plastic U-Mounting Bracket**
- Reverse voltage protection. Hi/Low voltage input protection

## FEATURES & BENEFITS

- **Kit comes in a set of 4pcs with a Plug & Go control module harness**
- **Super Wide Beam for improved colour clarity**
- Rubber Mounting Pad included
- Remote Controller included
- Reverse voltage protection

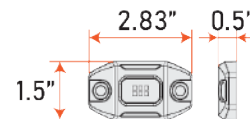
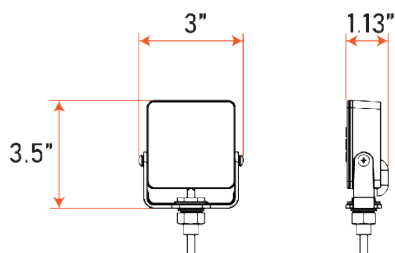

# ULTRA PERFORMANCE - DOUBLE ROW STRAIGHT

Ultra Bright, Ultra Powerful - For Off-Road Applications

ULTRA series LED flood lamps are HIGH LUMEN lamps with state of the art optic system. Equipped with Electronic Thermal Management System to prevent lamp from overheating. Finned aluminum body for heat dissipation. Emits natural white light which reduces eye fatigue.

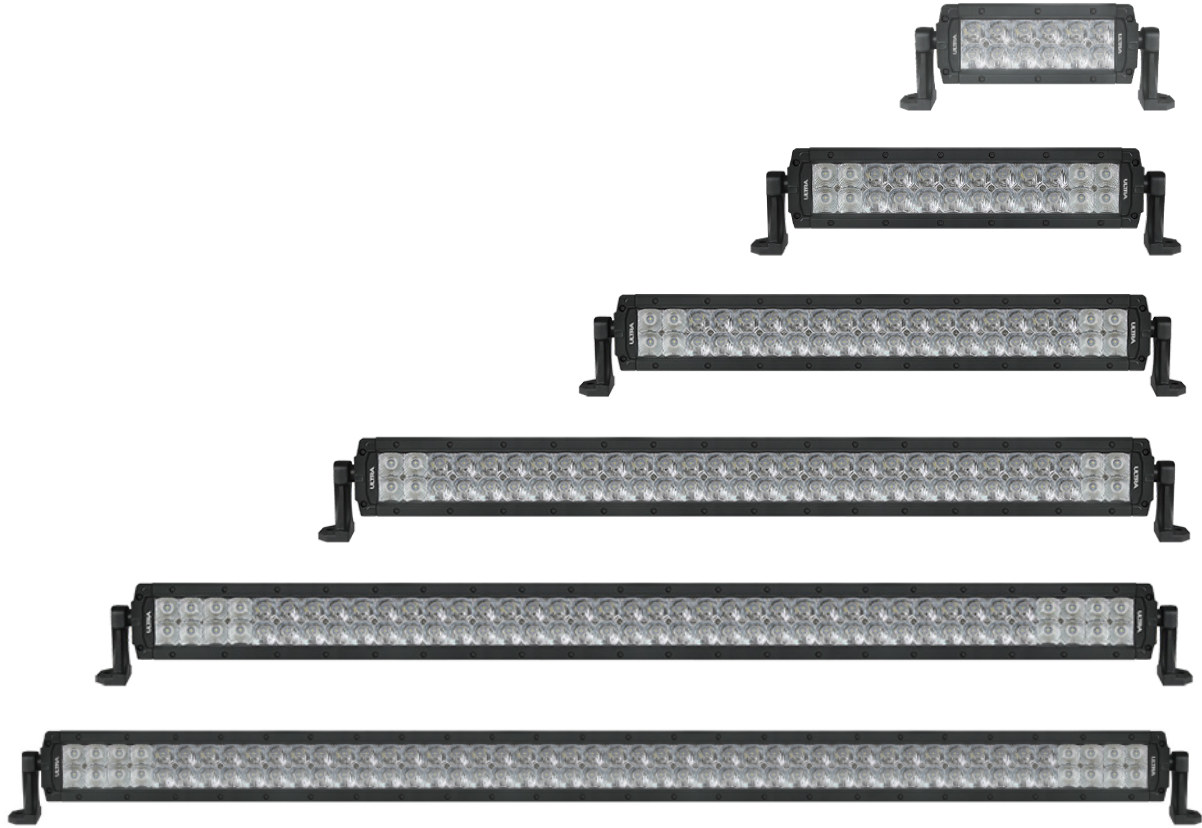

| Part No.                        | LW90709                    | LW91309                      | LW92109                        | LW93109                      | LW94109                      | LW95009                      |
|---------------------------------|----------------------------|------------------------------|--------------------------------|------------------------------|------------------------------|------------------------------|
| Length                          | 8"                         | 14"                          | 22"                            | 32"                          | 42"                          | 50"                          |
| Beam Pattern                    | Spot                       | Flood/Spot                   | Flood/Spot                     | Flood/Spot                   | Wide Flood/Spot              | Wide Flood/Spot              |
| Raw Lumens                      | 3240                       | 6480                         | 10800                          | 16200                        | 21600                        | 25920                        |
| Effective Lumens                | -                          | -                            | -                              | -                            | -                            | -                            |
| Optimal Penetration             | 2130 ft                    | 2600 ft                      | 3400 ft                        | 4380 ft                      | 4750 ft                      | 4910 ft                      |
| OSRAM LED                       | 12 x 3W                    | 24 x 3W                      | 40 x 3W                        | 60 x 3W                      | 80 x 3W                      | 96 x 3W                      |
| Amp Draw                        | 2.0 @ 12V                  | 4.0 @ 12V                    | 7.0 @ 12V                      | 10.0 @ 12V                   | 14.5 @ 12V                   | 18.0 @ 12V                   |
| Mounting (INCLUDED)             | Side ONLY                  | Side & Bottom                | Side & Bottom                  | Side & Bottom                | Side & Bottom                | Side & Bottom                |
| Harness                         | Included                   | Included                     | Included                       | Included                     | Included                     | Included                     |
| Lens Cover<br>(Sold Separately) | LWCR906-BKP<br>LWCR906-CRP | LWCR906-2BKP<br>LWCR906-2CRP | LWCR9068-3BKP<br>LWCR9068-3CRP | LWCR906-5BKP<br>LWCR906-5CRP | LWCR908-5BKP<br>LWCR908-5CRP | LWCR908-6BKP<br>LWCR908-6CRP |

| Voltage    | Housing                    | Lens          | IP Rating | EMC       | RoHS      |
|------------|----------------------------|---------------|-----------|-----------|-----------|
| 10V to 30V | High UV Resistant Aluminum | Polycarbonate | IP69K     | Certified | Certified |

## FEATURES & BENEFITS

- Premium OSRAM LEDs with Specially Designed Reflectors for Superior Performance
- 18ft Plug & Go Harness Kit with In-Dash ON-OFF Switch, Relay & Fuse (included)
- Built-In Waterproof Connector (male mating connector included)
- Dual Mount System (Side & Bottom Mounts included). EXCEPTION: LW90709
- Pressure relief vent
- Reverse voltage protection. Hi/Low voltage input protection

**ULTRA**performance

# ULTRA PERFORMANCE - DOUBLE ROW CURVED

Ultra Bright, Ultra Powerful - For Off-Road Applications

LED LIGHT BARS  
BARRES LUMINEUX À DEL



| Part No.                        | LW92169                        | LW93169                      | LW94169                      | LW95069                      |
|---------------------------------|--------------------------------|------------------------------|------------------------------|------------------------------|
| Length                          | 22"                            | 32"                          | 42"                          | 50"                          |
| Beam Pattern                    | Flood/Spot                     | Flood/Spot                   | Flood/Spot                   | Flood/Spot                   |
| Raw Lumens                      | 10800                          | 16200                        | 21600                        | 25920                        |
| Effective Lumens                | -                              | -                            | -                            | -                            |
| Optimal Penetration             | 2580 ft                        | 2650 ft                      | 2710 ft                      | 2780 ft                      |
| OSRAM LED                       | 40 x 3W                        | 60 x 3W                      | 80 x 3W                      | 96 x 3W                      |
| Amp Draw                        | 7.0 @ 12V                      | 10.0 @ 12V                   | 14.5 @ 12V                   | 18.0 @ 12V                   |
| Mounting (INCLUDED)             | Side & Bottom                  | Side & Bottom                | Side & Bottom                | Side & Bottom                |
| Harness                         | Included                       | Included                     | Included                     | Included                     |
| Lens Cover<br>(Sold Separately) | LWCR9068-3BKP<br>LWCR9068-3CRP | LWCR906-5BKP<br>LWCR906-5CRP | LWCR908-5BKP<br>LWCR908-5CRP | LWCR908-6BKP<br>LWCR908-6CRP |

| Voltage    | Housing                    | Lens          | IP Rating | EMC       | RoHS      |
|------------|----------------------------|---------------|-----------|-----------|-----------|
| 10V to 30V | High UV Resistant Aluminum | Polycarbonate | IP69K     | Certified | Certified |

## FEATURES & BENEFITS

- Premium OSRAM LEDs with Specially Designed Reflectors for Superior Performance
- 18ft Plug & Go Harness Kit with In-Dash ON-OFF Switch, Relay & Fuse (included)
- Built-In Waterproof Connector (male mating connector included)
- Dual Mount System (Side & Bottom Mounts included). EXCEPTION: LW90709
- Pressure relief vent
- Reverse voltage protection. Hi/Low voltage input protection

**ULTRA**performance

# ULTRA NXT - SINGLE ROW STRAIGHT

Ultra Bright & Comfort - For Off-Road Applications

ULTRA NXT series LED lamps are HIGH LUMEN lamps with state of the art optic system & precision equipment. Anti-glare reflectors are next generation tech in improving road safety with LEDs reaching far greater brightness. Equipped with Electronic Thermal Management System to prevent lamp from overheating. Finned aluminum body for heat dissipation. Drive with comfort, drive with confidence.



| Part No.                     | LW881008       | LW881808       | LW882008       | LW883208       | LW884008       | LW885008       |
|------------------------------|----------------|----------------|----------------|----------------|----------------|----------------|
| Length                       | 10"            | 18"            | 20"            | 32"            | 40"            | 50"            |
| Beam Pattern                 | Combo          | Combo          | Combo          | Combo          | Ext Combo      | Ext Combo      |
| Raw Lumens                   | 3780           | 7560           | 8820           | 13860          | 17640          | 22680          |
| Effective Lumens             | 2495 ~ 2054    | 5100 ~ 3904    | 5975 ~ 4652    | 9221 ~ 7445    | 11706 ~ 9499   | 14970 ~ 12324  |
| Optimal Penetration          | 2300 ~ 2050 ft | 3700 ~ 3000 ft | 4100 ~ 3600 ft | 5100 ~ 4460 ft | 5470 ~ 4400 ft | 7270 ~ 5400 ft |
| LED                          | 9 x 5W         | 18 x 5W        | 21 x 5W        | 33 x 5W        | 42 x 5W        | 54 x 5W        |
| Amp Draw                     | 3.4 @ 12V      | 6.3 @ 12V      | 8.0 @ 12V      | 12.5 @ 12V     | 14.9 @ 12V     | 19.2 @ 12V     |
| Mounting (INCLUDED)          | Side ONLY      | Bottom ONLY    | Side ONLY      | Side ONLY      | Side ONLY      | Side ONLY      |
| Harness                      | Not Included   | Not Included   | Not Included   | Not Included   | Not Included   | Not Included   |
| Lens Cover (Sold Separately) | -              | -              | -              | -              | -              | -              |

| Voltage    | Housing                    | Lens          | IP Rating | EMC       | RoHS      |
|------------|----------------------------|---------------|-----------|-----------|-----------|
| 12V to 30V | High UV Resistant Aluminum | Polycarbonate | IP69K     | Certified | Certified |

## FEATURES & BENEFITS

- **Electronic Thermal Management to control lamp temperature**
- **High Powered LEDs with Specially Designed Reflectors create an Anti-Glare light output**
- **18ft Plug & Go Harness Kit with In-Dash ON-OFF Switch, Relay & Fuse (sold seperately)**
- **Built-In Waterproof Connector (male mating connector included)**
- **Dual Mount System (Side Mounts included) EXCEPTION: LW881808 (Bottom Mounts are offered seperately)**
- Pressure relief valve
- Reverse voltage protection. Hi/Low voltage input protection



# ULTRA NXT - SINGLE ROW CURVED

Ultra Bright & Comfort - For Off-Road Applications

LED LIGHT BARS  
BARRES LUMINEUX À DEL



| Part No.                     | LW882068       | LW883268       | LW884068       | LW885068       |
|------------------------------|----------------|----------------|----------------|----------------|
| Length                       | 20"            | 32"            | 40"            | 50"            |
| Beam Pattern                 | Combo          | Combo          | Ext Combo      | Ext Combo      |
| Raw Lumens                   | 8820           | 13860          | 17640          | 22680          |
| Effective Lumens             | 5400 ~ 3700    | 7808 ~ 5147    | 8834 ~ 6219    | 11723 ~ 7365   |
| Optimal Penetration          | 3300 ~ 2900 ft | 2890 ~ 2300 ft | 2860 ~ 2180 ft | 3560 ~ 2680 ft |
| OSRAM LED                    | 21 x 5W        | 33 x 5W        | 42 x 5W        | 54 x 5W        |
| Amp Draw                     | 7.3 @ 12V      | 11.7 @ 12V     | 14.9 @ 12V     | 19.1 @ 12V     |
| Mounting (INCLUDED)          | Side ONLY      | Side ONLY      | Side ONLY      | Side ONLY      |
| Harness                      | Not Included   | Not Included   | Not Included   | Not Included   |
| Lens Cover (Sold Separately) | -              | -              | -              | -              |

| Voltage    | Housing                    | Lens          | IP Rating | EMC       | RoHS      |
|------------|----------------------------|---------------|-----------|-----------|-----------|
| 12V to 30V | High UV Resistant Aluminum | Polycarbonate | IP69K     | Certified | Certified |

## FEATURES & BENEFITS

- **Electronic Thermal Management** to control lamp temperature
- **High Powered LEDs with Specially Designed Reflectors** create an Anti-Glare light output
- **18ft Plug & Go Harness Kit with In-Dash ON-OFF Switch, Relay & Fuse** (sold separately)
- **Built-In Waterproof Connector** (male mating connector included)
- **Dual Mount System** (Side Mounts included) / (Bottom Mounts are offered separately)
- Pressure relief valve
- Reverse voltage protection. Hi/Low voltage input protection

**ULTRA NXT**



# ULTRA NXT - DOUBLE ROW

Ultra Bright & Comfort - For Off-Road Applications

ULTRA NXT series LED lamps are HIGH LUMEN lamps with state of the art optic system & precision equipment. Anti-glare reflectors are next generation tech in improving road safety with LEDs reaching far greater brightness. Equipped with Electronic Thermal Management System to prevent lamp from overheating. Finned aluminum body for heat dissipation. Drive with comfort, drive with confidence.



| Part No.                        | LW91308        | LW92108        | LW93008        | LW93068        |
|---------------------------------|----------------|----------------|----------------|----------------|
| Length                          | 13"            | 21.5"          | 30"            | 30" CURVED     |
| Beam Pattern                    | Combo          | Combo          | Ext Combo      | Ext Combo      |
| Raw Lumens                      | 10080          | 16800          | 25200          | 25200          |
| Effective Lumens                | 6600 ~ 4200    | 11000 ~ 7000   | 16500 ~ 10500  | 12264 ~ 7025   |
| Optimal Penetration             | 3900 ~ 3000 ft | 5200 ~ 3900 ft | 6000 ~ 4500 ft | 4000 ~ 3000 ft |
| OSRAM LED                       | 24 x 5W        | 40 x 5W        | 60 x 5W        | 60 x 5W        |
| Amp Draw                        | 7.7 @ 12V      | 14.6 @ 12V     | 20.8 @ 12V     | 20.8 @ 12V     |
| Mounting (INCLUDED)             | Side ONLY      | Side ONLY      | Side ONLY      | Side ONLY      |
| Harness                         | Not Included   | Not Included   | Not Included   | Not Included   |
| Lens Cover<br>(Sold Separately) | -              | -              | -              | -              |

| Voltage    | Housing                    | Lens          | IP Rating | EMC       | RoHS      |
|------------|----------------------------|---------------|-----------|-----------|-----------|
| 12V to 30V | High UV Resistant Aluminum | Polycarbonate | IP69K     | Certified | Certified |

## FEATURES & BENEFITS

- **Electronic Thermal Management to control lamp temperature**
- **High Powered LEDs with Specially Designed Reflectors create an Anti-Glare light output**
- **18ft Plug & Go Harness Kit with In-Dash ON-OFF Switch, Relay & Fuse (sold seperately)**
- **Built-In Waterproof Connector (male mating connector included)**
- **Dual Mount System (Side Mounts included) / (Bottom Mounts are offered seperately)**
- Pressure relief valve
- Reverse voltage protection. Hi/Low voltage input protection





# ULTRA NXT - COMBO BAR

Ultra Bright & Comfort - For Off-Road Applications

LED LIGHT BARS  
BARRES LUMINEUX À DEL



| Part No.        | Beam Pattern              | Opt. Penetration | Colour |
|-----------------|---------------------------|------------------|--------|
| <b>LW881038</b> | Combo<br>+ Position Light | 2300 ft          | White  |

|                  |                            |
|------------------|----------------------------|
| Length           | 10"                        |
| Raw Lumens       | 3780                       |
| Effective Lumens | 2703                       |
| LED              | 9 x 5W                     |
| Voltage          | 12V - 30V                  |
| Amp Draw         | 3.0 @ 12V                  |
| Housing          | High UV Resistant Aluminum |
| Lens             | Polycarbonate              |
| CISPR25 Rating   | -                          |
| IP Rating        | IP69K                      |
| EMC              | Certified                  |
| RoHS             | Certified                  |
| Connection       | 2x Lead Wires              |

## FEATURES & BENEFITS

- **Electronic Thermal Management** to control lamp temperature
- **Anti-Glare Reflectors**
- **18ft Plug & Go Harness Kit** (sold separately)
- **Built-In Waterproof Connector** (male mating connector included)
- **Side Mounts included** - Bottom Mounts are offered separately
- Pressure relief valve
- Reverse voltage protection. Hi/Low voltage input protection

**ULTRA NXT Light Bars**  
use next generation tech by  
incorporating anti-glare reflectors  
to provide a more focused beam



**See & Feel Different**  
**Look Good being different**

**With ULTRA NXT Light Bars**



**Without ULTRA NXT Light Bars**

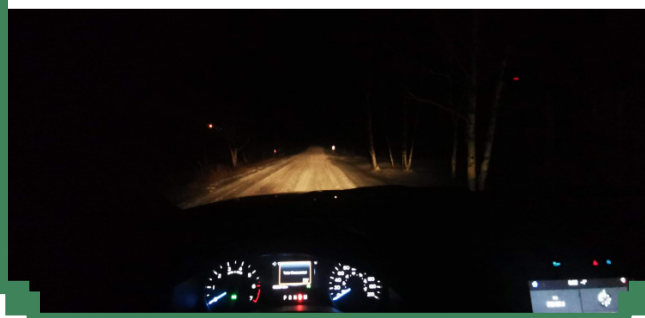

# SCORCH - DOUBLE ROW STRAIGHT

Super Bright & Powerful - For Off-Road Applications

SCORCH series LED light bars are HIGH LUMEN lamps with state of the art optic system. Finned aluminum body for heat dissipation. Emits natural white light which reduces eye fatigue. Plug & Go Harness are sold separately.



| Part No.                        | LW90705                    | LW91305                      | LW92105                        | LW93105                      | LW94105                      | LW95005                      |
|---------------------------------|----------------------------|------------------------------|--------------------------------|------------------------------|------------------------------|------------------------------|
| Length                          | 8"                         | 14"                          | 22"                            | 32"                          | 42"                          | 50"                          |
| Beam Pattern                    | Spot                       | Flood/Spot                   | Flood/Spot                     | Flood/Spot                   | Wide Flood/Spot              | Wide Flood/Spot              |
| Raw Lumens                      | 2340                       | 4680                         | 7800                           | 11700                        | 15600                        | 18720                        |
| Effective Lumens                | -                          | -                            | -                              | -                            | -                            | -                            |
| Optimal Penetration             | 900 ft                     | 1300 ft                      | 1600 ft                        | 2100 ft                      | 2200 ft                      | 2300 ft                      |
| OSRAM LED                       | 12 x 1.5W                  | 24 x 1.5W                    | 40 x 1.5W                      | 60 x 1.5W                    | 80 x 1.5W                    | 96 x 1.5W                    |
| Amp Draw                        | 1.6 @ 12V                  | 3.1 @ 12V                    | 5.6 @ 12V                      | 8.3 @ 12V                    | 11.6 @ 12V                   | 14.1 @ 12V                   |
| Mounting (INCLUDED)             | Side ONLY                  | Side ONLY                    | Side ONLY                      | Side ONLY                    | Side ONLY                    | Side ONLY                    |
| Harness                         | Not Included               | Not Included                 | Not Included                   | Not Included                 | Not Included                 | Not Included                 |
| Lens Cover<br>(Sold Separately) | LWCR906-BKP<br>LWCR906-CRP | LWCR906-2BKP<br>LWCR906-2CRP | LWCR9068-3BKP<br>LWCR9068-3CRP | LWCR906-5BKP<br>LWCR906-5CRP | LWCR908-5BKP<br>LWCR908-5CRP | LWCR908-6BKP<br>LWCR908-6CRP |

| Voltage    | Housing                    | Lens          | IP Rating | EMC       | RoHS      |
|------------|----------------------------|---------------|-----------|-----------|-----------|
| 10V to 30V | High UV Resistant Aluminum | Polycarbonate | IP69K     | Certified | Certified |

## FEATURES & BENEFITS

- OSRAM LEDs with Specially Designed Reflectors for Cost-Saving Performance
- 18ft Plug & Go Harness Kit with In-Dash ON-OFF Switch, Relay & Fuse (sold separately)
- Built-In Waterproof Connector (male mating connector included)
- Dual Mount System (Side Mounts included) / (Bottom Mounts are offered separately)
- Pressure relief vent
- Reverse voltage protection. Hi/Low voltage input protection



# SCORCH - DOUBLE ROW CURVED

Super Bright & Powerful - For Off-Road Applications

LED LIGHT BARS  
BARRES LUMINEUX À DEL



| Part No.                     | LW92165                        | LW93165                      | LW94165                      | LW95065                      |
|------------------------------|--------------------------------|------------------------------|------------------------------|------------------------------|
| Length                       | 22"                            | 32"                          | 42"                          | 50"                          |
| Beam Pattern                 | Flood/Spot                     | Flood/Spot                   | Flood/Spot                   | Flood/Spot                   |
| Raw Lumens                   | 7800                           | 11700                        | 15600                        | 18720                        |
| Effective Lumens             | -                              | -                            | -                            | -                            |
| Optimal Penetration          | 1400 ft                        | 1700 ft                      | 1700 ft                      | 1750 ft                      |
| OSRAM LED                    | 40 x 1.5W                      | 60 x 1.5W                    | 80 x 1.5W                    | 96 x 1.5W                    |
| Amp Draw                     | 5.6 @ 12V                      | 8.3 @ 12V                    | 11.6 @ 12V                   | 14.1 @ 12V                   |
| Mounting (INCLUDED)          | Side ONLY                      | Side ONLY                    | Side ONLY                    | Side ONLY                    |
| Harness                      | Not Included                   | Not Included                 | Not Included                 | Not Included                 |
| Lens Cover (Sold Separately) | LWCR9068-3BKP<br>LWCR9068-3CRP | LWCR906-5BKP<br>LWCR906-5CRP | LWCR908-5BKP<br>LWCR908-5CRP | LWCR908-6BKP<br>LWCR908-6CRP |

| Voltage    | Housing                    | Lens          | IP Rating | EMC       | RoHS      |
|------------|----------------------------|---------------|-----------|-----------|-----------|
| 10V to 30V | High UV Resistant Aluminum | Polycarbonate | IP69K     | Certified | Certified |

## FEATURES & BENEFITS

- OSRAM LEDs with Specially Designed Reflectors for Cost-Saving Performance
- 18ft Plug & Go Harness Kit with In-Dash ON-OFF Switch, Relay & Fuse (sold separately)
- Built-In Waterproof Connector (male mating connector included)
- Dual Mount System (Side Mounts included) / (Bottom Mounts are offered separately)
- Pressure relief vent
- Reverse voltage protection. Hi/Low voltage input protection



# LED DUAL LAMP KITS

Designed for those who just want to brighten up their day. Hassle free installation - For Off-Road Applications



| Part No.          | Description                                 |
|-------------------|---|
| <b>LW0302S-2K</b> | (2x) LW0302S with Female Deutsch Connectors |
| <b>LW0303S-2K</b> | (2x) LW0303S with Female Deutsch Connectors |

See Page 37 for individual Lamp Specifications

### KIT CONTENTS

- 18ft PLUG & GO Harness, Switch & Fuse included

| Part No.         | Description                                |
|------------------|--|
| <b>LW0328-2K</b> | (2x) LW0328 with Female Deutsch Connectors |
| <b>LW0338-2K</b> | (2x) LW0338 with Female Deutsch Connectors |

See Page 24 for individual Lamp Specifications

### KIT CONTENTS

- 18ft PLUG & GO Harness, Switch & Fuse included



| Part No.          | Description   |
|-------------------|---|
| <b>LW3029-2K</b>  | (2x) LW3029 with Female Deutsch Connectors          |
| <b>LW3029-2KM</b> | (2x) LW3029 with Magnet & Female Deutsch Connectors |

See Page 23 for individual Lamp Specifications

### KIT CONTENTS

- 18ft PLUG & GO Harness, Switch & Fuse included

| Part No.         | Description                                |
|------------------|--|
| <b>LW6007-2K</b> | (2x) LW6007 with Female Deutsch Connectors |
| <b>LW6008-2K</b> | (2x) LW6008 with Female Deutsch Connectors |
| <b>LW6009-2K</b> | (2x) LW6009 with Female Deutsch Connectors |

See Page 38 for individual Lamp Specifications

### KIT CONTENTS

- 18ft PLUG & GO Harness, Switch & Fuse included



| Part No.         | Description                                |
|------------------|--|
| <b>LW4262-2K</b> | (2x) LW4262 with Female Deutsch Connectors |

See Page 30 for individual Lamp Specifications

### KIT CONTENTS

- 18ft PLUG & GO Harness, Switch & Fuse included

| Part No.         | Description                                |
|------------------|--|
| <b>LW4329-2K</b> | (2x) LW4329 with Female Deutsch Connectors |

See Page 17 for individual Lamp Specifications

### KIT CONTENTS

- 18ft PLUG & GO Harness, Switch & Fuse included



# LED WORK LAMP KITS

Designed for those who just want to brighten up their day. Hassle free installation - For Off-Road Applications

LED LAMP KITS  
KIT DE LAMPES DEL

| Part No.   | Description          | Opt. Penetration |
|------------|----------------------|------------------|
| LW881038K2 | (1x) 10" Light Bar   | 2300 ft          |
|            | (2x) 2.75" Cube Lamp | 400 ft           |

## 10" LIGHT BAR SPECIFICATIONS

|                  |                            |
|------------------|----------------------------|
| Raw Lumens       | 3780                       |
| Effective Lumens | 2703                       |
| LED              | 9 x 5W                     |
| Voltage          | 12V - 30V                  |
| Amp Draw         | 3.0 @ 12V                  |
| Housing          | High UV Resistant Aluminum |
| Lens             | Tempered Glass             |
| CISPR25 Rating   | -                          |
| IP Rating        | IP69K                      |
| EMC              | Certified                  |
| RoHS             | Certified                  |
| Connection       | Deutsch Connector          |

## 2.75" CUBE LAMP SPECIFICATIONS

|                  |                            |
|------------------|----------------------------|
| Raw Lumens       | 1920                       |
| Effective Lumens | -                          |
| LED              | 4 x 5W                     |
| Voltage          | 12V - 30V                  |
| Amp Draw         | 1.94 @ 12V                 |
| Housing          | High UV Resistant Aluminum |
| Lens             | Polycarbonate              |
| CISPR25 Rating   | -                          |
| IP Rating        | IP69K                      |
| EMC              | Certified                  |
| RoHS             | Certified                  |
| Connection       | Deutsch Connector          |

## FEATURES & BENEFITS

- **Electronic Thermal Management** to control lamp temperature
- **Anti-Glare Reflectors**
- **18ft Plug & Go Harness Kit (included)**
- **Built-In Waterproof Connector (male mating connector included)**
- **Side Mounts included - Bottom Mounts are offered seperately**
- Pressure relief valve
- Reverse voltage protection. Hi/Low voltage input protection



# 9.75" LOW PROFILE - AMBER

SAE Class 1

Compact but powerful 360° LED Warning Light Bars. Small enough to fit in a glove compartment.

**E-2110AC**



**E-2110ACB**



**E-2110ACM**



| Part No.         | Mounting             | Connection                             |
|------------------|----------------------|--|
| <b>E-2110AC</b>  | Double Bracket Mount | 3x Lead Wires                          |
| <b>E-2110ACB</b> | Single Bolt Mount    | 3x Lead Wires                          |
| <b>E-2110ACM</b> | Magnetic Mount       | 9.8ft Cigarette Adaptor w/ Dual Switch |

### FEATURES & BENEFITS

- Synchronize up to 8 units easily with dedicated sync wire
- 23 Flash Patterns (includes Rotating Flash)
- Dimming Function capable

### ACCESSORIES

- F-S957** Fuse/Switch Kit for E-2110AC & E-2110ACB
- E-F212** Replacement Double Brackets (sold in pairs)
- E-F211** Replacement Single Bolt Bracket
- E-F212M** Replacement Magnet Set

|                |  |
|----------------|--|
| LED Colour     | Amber  |
| Lens Colour    | Clear  |
| LED            | 30 x 1W  |
| Flash Patterns | 23 Patterns  |
| Voltage        | 12V - 24V  |
| Amp Draw       | 3.8 @ 12V  |
| SAE            | SAE J845 Class 1 on 3 Flashes<br>SAE J845 Class 2 on 3 Flashes |
| Housing        | Polycarbonate Base   |
| Lens           | Polycarbonate  |
| IP Rating      | IP64K  |
| EMC            | Certified  |
| RoHS           | -  |
| Dimensions     | 9.75" L x 6.75" W x 1.5" H                                     |

**E-2210AC**



**E-2210A**

**E-2210ACM**



**E-2210AM**

| Part No.         | Mounting               | Connection                            |
|------------------|------------------------|---------------------------------------|
| <b>E-2210A</b>   | Double Bracket Mount   | 3x Lead Wires                         |
| <b>E-2210AC</b>  |                        |                                       |
| <b>E-2210AM</b>  | Magnetic Suction Mount | 12ft Cigarette Adaptor w/ Dual Switch |
| <b>E-2210ACM</b> |                        |                                       |

### FEATURES & BENEFITS

- Synchronize up to 8 units easily with dedicated sync wire
- 23 Flash Patterns (includes Rotating Flash)
- Dimming Function capable

### ACCESSORIES

- F-S936** Fuse/Switch Kit for E-2210A & E-2210AC
- E-F222** Replacement Double Brackets (sold in pairs)
- E-F222M** Replacement Magnet Set

|                |                             |
|----------------|-----------------------------|
| LED Colour     | Amber                       |
| Lens Colour    | Amber or Clear              |
| LED            | 30 x 1W                     |
| Flash Patterns | 23 Patterns                 |
| Voltage        | 12V - 24V                   |
| Amp Draw       | 3.0 @ 12V                   |
| SAE            | SAE J845 Class 1 on 1 Flash |
| Housing        | Polycarbonate Base          |
| Lens           | Polycarbonate               |
| IP Rating      | IP64K                       |
| EMC            | Certified                   |
| RoHS           | -                           |
| Dimensions     | 9.75" L x 6.75" W x 1.5" H  |



# 9.75" LOW PROFILE - AMBER

SAE Class 1

LED WARNING LIGHT BARS  
BARRE DE FEUX D'AVERTISSEUR DEL

**E-2107AC**



**E-2107ACM**



| Part No.         | Mounting               | Connection                           |
|------------------|------------------------|--------------------------------------|
| <b>E-2107AC</b>  | Single Bolt Mount      | 4x Lead Wires                        |
| <b>E-2107ACM</b> | Magnetic Suction Mount | 8ft Cigarette Adaptor w/ Dual Switch |

#### FEATURES & BENEFITS

- Synchronize up to 8 units easily with dedicated sync wire
- 30 Flash Patterns (includes Rotating Flash & Steady Light)
- Dimming Function capable

#### ACCESSORIES

**F-S936** Fuse/Switch Kit for E-2107AC

|                |                               |
|----------------|-------------------------------|
| LED Colour     | Amber                         |
| Lens Colour    | Clear w/ Black Top            |
| LED            | 24 x 1W                       |
| Flash Patterns | 30 Patterns                   |
| Voltage        | 12V - 24V                     |
| Amp Draw       | 1.85 @ 12V                    |
| SAE            | SAE J845 Class 1 on 5 Flashes |
| Housing        | Polycarbonate Base            |
| Lens           | Polycarbonate                 |
| IP Rating      | IP66                          |
| EMC            | Certified                     |
| RoHS           | -                             |
| Dimensions     | 9.75" L x 6.75" W x 1.6" H    |

**E-2103A**



**E-2103AM**



| Part No.        | Mounting               | Connection                             |
|-----------------|------------------------|--|
| <b>E-2103A</b>  | Single Bolt Mount      | 3x Lead Wires                          |
| <b>E-2103AM</b> | Magnetic Suction Mount | 9.5ft Cigarette Adaptor w/ Dual Switch |

#### FEATURES & BENEFITS

- Synchronize up to 8 units easily with dedicated sync wire
- 26 Flash Patterns (includes Rotating Flash & Steady Light)
- Dimming Function capable

#### ACCESSORIES

**F-S936** Fuse/Switch Kit for E-2103A

|                |                             |
|----------------|-----------------------------|
| LED Colour     | Amber                       |
| Lens Colour    | Smoky                       |
| LED            | 60 x 1.5W                   |
| Flash Patterns | 26 Patterns                 |
| Voltage        | 12V - 24V                   |
| Amp Draw       | 2.75 @ 12V                  |
| SAE            | SAE J845 Class 1 on 1 Flash |
| Housing        | Polycarbonate Base          |
| Lens           | Polycarbonate               |
| IP Rating      | IP67                        |
| EMC            | Certified                   |
| RoHS           | -                           |
| Dimensions     | 9.75" L x 6.75" W x 1.5" H  |

# 10.5" STANDARD - AMBER

SAE Class 1

Compact but powerful 360° LED Warning Light Bars. Medium Profile.

**E-2102AC**



**E-2102ACM**



| Part No.         | Mounting          | Connection                           |
|------------------|-------------------|--------------------------------------|
| <b>E-2102AC</b>  | Single Bolt Mount | 5x Lead Wires                        |
| <b>E-2102ACM</b> | Magnetic Mount    | 8ft Cigarette Adaptor w/ Dual Switch |

### FEATURES & BENEFITS

- Synchronize up to 2 units easily with dedicated sync wire
- 26 Flash Patterns (includes multitudes of Rotating & Steady Light)
- Dimming Function capable

### ACCESSORIES

**F-S936** Fuse/Switch Kit for E-2102AC

|                |                             |
|----------------|-----------------------------|
| LED Colour     | Amber                       |
| Lens Colour    | Milky White                 |
| LED            | 60 x 1.5W                   |
| Flash Patterns | 26 Patterns                 |
| Voltage        | 10V - 30V                   |
| Amp Draw       | 3.5 @ 12V                   |
| SAE            | SAE J845 Class 1 on 1 Flash |
| Housing        | ABS Base                    |
| Lens           | Polycarbonate               |
| IP Rating      | IP67                        |
| EMC            | Certified                   |
| RoHS           | -                           |
| Dimensions     | 10.6" L x 6.33" W x 1.88" H |



| Part No.          | Mounting               | Connection                             |
|-------------------|------------------------|--|
| <b>E-21010ACM</b> | Magnetic Suction Mount | 9.5ft Cigarette Adaptor w/ Dual Switch |

### FEATURES & BENEFITS

- Improved Top Durability, great for construction sites
- 17 Flash Patterns (includes Rotating Flash & Steady Light)

### ACCESSORIES

**F-S936** Fuse/Switch Kit for E-21010ACM

|                |                             |
|----------------|-----------------------------|
| LED Colour     | Amber                       |
| Lens Colour    | Clear w/ Black Top          |
| LED            | 60 x 1W                     |
| Flash Patterns | 17 Patterns                 |
| Voltage        | 12V - 24V                   |
| Amp Draw       | 1.85 @ 12V                  |
| SAE            | SAE J845 Class 1 on 1 Flash |
| Housing        | ABS Top Shield              |
| Lens           | Polycarbonate               |
| IP Rating      | IP67                        |
| EMC            | Certified                   |
| RoHS           | -                           |
| Dimensions     | 10.6" L x 6.33" W x 1.88" H |

# 15" LOW PROFILE - AMBER

SAE Class 1

LED WARNING LIGHT BARS  
BARRE DE FEUX D'AVERTISSEUR DEL



| Part No.       | Mounting          | Connection    |
|----------------|-------------------|---------------|
| <b>E-2143A</b> | Single Bolt Mount | 5x Lead Wires |

#### FEATURES & BENEFITS

- Synchronize up to 8 units easily with dedicated sync wire
- 26 Flash Patterns (includes Rotating Flash & Steady Light)
- Dimming Function capable

#### ACCESSORIES

**F-S936** Fuse/Switch Kit for E-2143A

|                |                             |
|----------------|-----------------------------|
| LED Colour     | Amber                       |
| Lens Colour    | Smoky                       |
| LED            | 72 x 1.5W                   |
| Flash Patterns | 26 Patterns                 |
| Voltage        | 12V - 24V                   |
| Amp Draw       | 4.1 @ 12V                   |
| SAE            | SAE J845 Class 1 on 1 Flash |
| Housing        | ABS Base                    |
| Lens           | Polycarbonate               |
| IP Rating      | IP67                        |
| EMC            | Certified                   |
| RoHS           | -                           |
| Dimensions     | 14.33" L x 6.75" W x 1.5" H |



| Part No.        | Mounting               | Connection               |
|-----------------|------------------------|--------------------------|
| <b>E-2150AM</b> | Magnetic Suction Mount | 12.5ft Cigarette Adaptor |

#### FEATURES & BENEFITS

- Aluminum Top to protect against debris
- Simple 1 pattern light for easy access

|                |                               |
|----------------|-------------------------------|
| LED Colour     | Amber                         |
| Lens Colour    | Amber                         |
| LED            | 32 x 1W                       |
| Flash Patterns | Quad Alternating Left & Right |
| Voltage        | 12V - 24V                     |
| Amp Draw       | 0.85 @ 12V                    |
| SAE            | SAE J595 Class 1              |
| Housing        | Aluminum Top & Bottom         |
| Lens           | Polycarbonate                 |
| IP Rating      | IP65                          |
| EMC            | Certified                     |
| RoHS           | -                             |
| Dimensions     | 15" L x 3.69" W x 1.44" H     |

# 16" LOW PROFILE - AMBER

SAE Class 1

Compact but powerful 360° LED Warning Light Bars.

**E-2115AC**



**E-2115ACM**



| Part No.         | Mounting             | Connection                             |
|------------------|----------------------|--|
| <b>E-2115AC</b>  | Double Bracket Mount | 3x Lead Wires                          |
| <b>E-2115ACM</b> | Magnetic Mount       | 9.8ft Cigarette Adaptor w/ Dual Switch |

**FEATURES & BENEFITS**

- Synchronize up to 2 units easily with dedicated sync wire
- 24 Flash Patterns (includes multitudes of Rotating)

**ACCESSORIES**

- F-S976** Fuse/Switch Kit for E-2115AC
- E-F212** Replacement Brackets (sold in pairs) for E-2115AC
- E-F212M** Replacement Magnet Set for E-2115ACM

|                |  |
|----------------|--|
| LED Colour     | Amber  |
| Lens Colour    | Clear  |
| LED            | 42 x 1W  |
| Flash Patterns | 24 Patterns  |
| Voltage        | 12V - 24V  |
| Amp Draw       | 6.2 @ 12V  |
| SAE            | SAE J845 Class 1 on 4 Flashes<br>SAE J845 Class 2 on 1 Flash |
| Housing        | Polycarbonate Base   |
| Lens           | Polycarbonate  |
| IP Rating      | IP64K  |
| EMC            | Certified  |
| RoHS           | -  |
| Dimensions     | 16" L x 7" W x 1.5" H  |

**E-2215AC**



**E-2215ACM**



| Part No.         | Mounting               | Connection                            |
|------------------|------------------------|---------------------------------------|
| <b>E-2215AC</b>  | Double Bracket Mount   | 3x Lead Wires                         |
| <b>E-2215ACM</b> | Magnetic Suction Mount | 12ft Cigarette Adaptor w/ Dual Switch |

**FEATURES & BENEFITS**

- Synchronize up to 2 units easily with dedicated sync wire
- 23 Flash Patterns (includes Rotating)

**ACCESSORIES**

- F-S936** Fuse/Switch Kit for E-2215AC
- E-F223** Replacement Brackets (sold in pairs) for E-2215AC

|                |                             |
|----------------|-----------------------------|
| LED Colour     | Amber                       |
| Lens Colour    | Clear                       |
| LED            | 30 x 1W                     |
| Flash Patterns | 23 Patterns                 |
| Voltage        | 12V - 24V                   |
| Amp Draw       | 3.0 @ 12V                   |
| SAE            | SAE J845 Class 1 on 1 Flash |
| Housing        | Polycarbonate Base          |
| Lens           | Polycarbonate               |
| IP Rating      | IP65K                       |
| EMC            | Certified                   |
| RoHS           | -                           |
| Dimensions     | 16" L x 8" W x 1.5" H       |

# 16.5" STANDARD - AMBER

SAE Class 1

Compact but powerful 360° LED Warning Light Bars. Medium Profile.

LED WARNING LIGHT BARS  
BARRE DE FEUX D'AVERTISSEUR DEL



E-2161AC



E-2161A



E-2161AM



E-2161ACM

| Part No.  | Mounting               | Connection                            |
|-----------|------------------------|---------------------------------------|
| E-2161A   | Double Bracket Mount   | 4x Lead Wires                         |
| E-2161AC  |                        |                                       |
| E-2161AM  | Magnetic Suction Mount | 10ft Cigarette Adaptor w/ Dual Switch |
| E-2161ACM |                        |                                       |

|                |                               |
|----------------|-------------------------------|
| LED Colour     | Amber                         |
| Lens Colour    | Amber (A) or Clear (AC)       |
| LED            | 18 x 1W                       |
| Flash Patterns | 19 Patterns                   |
| Voltage        | 12V                           |
| Amp Draw       | 3.1 @ 12V                     |
| SAE            | SAE J845 Class 1 on 3 Flashes |
| Housing        | Polycarbonate Base            |
| Lens           | Polycarbonate                 |
| IP Rating      | IP64K                         |
| EMC            | Certified                     |
| RoHS           | -                             |
| Dimensions     | 16.63" L x 6.38" W x 3" H     |

#### FEATURES & BENEFITS

- Synchronize up to 4 units easily with dedicated sync wire
- 19 Flash Patterns (includes Steady Light)
- Dimming Function capable

#### ACCESSORIES

- F-S958 Fuse/Switch Kit for E-2161A & E-2161AC
- E-F216 Replacement Double Brackets (sold in pairs)



E-2163AC

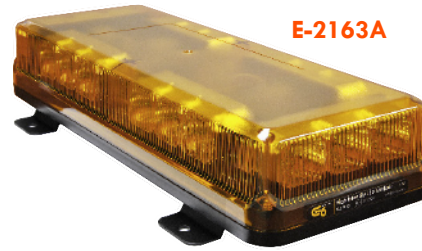

E-2163A

| Part No. | Mounting             | Connection    |
|----------|----------------------|---------------|
| E-2163A  | Double Bracket Mount | 4x Lead Wires |
| E-2163AC | Double Bracket Mount | 4x Lead Wires |

|                |  |
|----------------|--|
| LED Colour     | Amber  |
| Lens Colour    | Amber (A) or Clear (AC)  |
| LED            | 18 x 1W  |
| Flash Patterns | 19 Patterns  |
| Voltage        | 12V  |
| Amp Draw       | 3.1 @ 12V  |
| SAE            | SAE J845 Class 1 on 2 Flashes<br>SAE J845 Class 2 on 3 Flashes |
| Housing        | Polycarbonate Base   |
| Lens           | Polycarbonate  |
| IP Rating      | IP64K  |
| EMC            | Certified  |
| RoHS           | -  |
| Dimensions     | 16.63" L x 6.38" W x 3" H                                      |

#### FEATURES & BENEFITS

- Synchronize up to 4 units easily with dedicated sync wire
- 19 Flash Patterns (includes Rotating)
- Dimming Function capable

#### ACCESSORIES

- F-S958 Fuse/Switch Kit for E-2163A & E-2163AC
- E-F216 Replacement Double Brackets (sold in pairs)

# 23" LOW PROFILE - AMBER

SAE Class 1

Compact but powerful 360° LED Warning Light Bars. Wide but low profile.



| Part No.        | Mounting             | Connection    |
|-----------------|----------------------|---------------|
| <b>E-2223AC</b> | Double Bracket Mount | 3x Lead Wires |

### FEATURES & BENEFITS

- Synchronize up to 2 units easily with dedicated sync wire
- 23 Flash Patterns (includes Rotating)

### ACCESSORIES

- F-S976** Fuse/Switch Kit for E-2223AC
- E-F223** Replacement Brackets (sold in pairs)

|                |                               |
|----------------|-------------------------------|
| LED Colour     | Amber                         |
| Lens Colour    | Clear                         |
| LED            | 42 x 1W                       |
| Flash Patterns | 23 Patterns                   |
| Voltage        | 12V - 24V                     |
| Amp Draw       | 6.2 @ 12V                     |
| SAE            | SAE J845 Class 1 on 3 Flashes |
| Housing        | Polycarbonate Base            |
| Lens           | Polycarbonate                 |
| IP Rating      | IP65                          |
| EMC            | Certified                     |
| RoHS           | -                             |
| Dimensions     | 23" L x 6.75" W x 2.5" H      |



| Part No.        | Mounting               | Connection                                       |
|-----------------|------------------------|--|
| <b>E-2232AM</b> | Magnetic Suction Mount | 12.5ft Cigarette Adaptor w/ Single Button Switch |

### FEATURES & BENEFITS

- 12 Flash Patterns (includes Steady Light)

### ACCESSORIES

- F-S976** Fuse/Switch Kit for E-2223AC
- E-F223** Replacement Brackets (sold in pairs)

|                |                           |
|----------------|---------------------------|
| LED Colour     | Amber                     |
| Lens Colour    | Amber                     |
| LED            | 40 x 1W                   |
| Flash Patterns | 12 Patterns               |
| Voltage        | 12V - 30V                 |
| Amp Draw       | 1.0 @ 12V                 |
| SAE            | -                         |
| Housing        | Aluminum Top & Bottom     |
| Lens           | Polycarbonate             |
| IP Rating      | IP65                      |
| EMC            | Certified                 |
| RoHS           | -                         |
| Dimensions     | 23" L x 3.69" W x 1.44" H |



# 24" LOW PROFILE - AMBER

SAE Class 1

Compact but powerful 360° LED Warning Light Bars. Wide but low profile.



| Part No.        | Mounting             | Connection    |
|-----------------|----------------------|---------------|
| <b>E-2324AC</b> | Double Bracket Mount | 3x Lead Wires |

#### FEATURES & BENEFITS

- Adjustable Permanent Mount (mount as a clamp or on surface)
- 27 Flash Patterns (includes Directional Flash & Steady Light)

|                |                             |
|----------------|-----------------------------|
| LED Colour     | Amber                       |
| Lens Colour    | Clear                       |
| LED            | 162 x 0.4W                  |
| Flash Patterns | 27 Patterns                 |
| Voltage        | 12V - 24V                   |
| Amp Draw       | 2.1 @ 12V                   |
| SAE            | SAE J845 Class 1 on 1 Flash |
| Housing        | ABS Top & Bottom            |
| Lens           | Polycarbonate               |
| IP Rating      | IP67                        |
| EMC            | Certified                   |
| RoHS           | -                           |
| Dimensions     | 24" L x 6.75" W x 2" H      |

**NOTHING LOOKS  
BETTER THAN BEING  
SAFE**

**Low Profile** design  
slim warning light bars offer an  
aesthetic that matches any vehicle  
& provides **SAE CLASS 1**

**LED WARNING LIGHT BARS  
BARRE DE FEUX D'AVERTISSEUR DEL**

# 45" LOW PROFILE - AMBER

SAE Class 1

Compact but powerful 360° LED Warning Light Bars.



| Part No.       | Mounting               | Connection        |
|----------------|------------------------|-------------------|
| <b>E-2450A</b> | Double Permanent Mount | 8-Pin Control Box |

### FEATURES & BENEFITS

- Can be mounted on surface or clamp on to cabin
- 8 Flash Patterns (includes Directional Flash)
- Hardware and Control Box included

### ACCESSORIES

- E-F700-2** Steel Plated Extension Bar
- E-F255** Low Profile Aluminum Brackets (sold in pairs)
- E-F065-8** 6.5ft Extension Wire
- E-F260-8** 26ft Extension Wire
- E-F200-8** Replacement Control Box
- E-F250** Replacement Brackets (sold in pairs)

|                |  |
|----------------|--|
| LED Colour     | Amber  |
| Lens Colour    | Amber  |
| LED            | 72 x 1W  |
| Flash Patterns | 8 Patterns   |
| Voltage        | 12V - 24V  |
| Amp Draw       | 5.6 @ 12V  |
| SAE            | SAE J595 Class 1 on 1 Flash<br>SAE J595 Class 2 on 3 Flashes |
| Housing        | Aluminum Top & Bottom  |
| Lens           | Polycarbonate  |
| IP Rating      | IP65   |
| EMC            | Certified  |
| RoHS           | -  |
| Dimensions     | 45" L x 3.69" W x 1.44" H                                    |



| Part No.        | Mounting               | Connection    |
|-----------------|------------------------|---------------|
| <b>E-2457A1</b> | Double Permanent Mount | 2x Lead Wires |

### FEATURES & BENEFITS

- Can be mounted on surface or clamp on to cabin
- 15 Flash Patterns (includes Directional Flash & Rotating)
- 23 ft wire from controller to light
- 3.2 ft power cable from light to vehicle
- Hardware and Controller included

### ACCESSORIES

- E-F246** Replacement Controller
- E-F247** Replacement Harness

|                |                                       |
|----------------|---------------------------------------|
| LED Colour     | Amber Warning & White Take-Down/Alley |
| Lens Colour    | Clear                                 |
| LED            | 144 (Amber LED) & 18 (White LED)      |
| Flash Patterns | 15 Patterns                           |
| Voltage        | 12V                                   |
| Amp Draw       | up to 8.5 @ 12V                       |
| SAE            | SAE J595 Class 1 on 4 Flashes         |
| Housing        | Aluminum Top & Bottom                 |
| Lens           | Polycarbonate                         |
| IP Rating      | IP68                                  |
| EMC            | Certified                             |
| RoHS           | Certified                             |
| Dimensions     | 44.75" L x 9.5" W x 3.5" H            |

# 11" STANDARD - DUAL COLOUR

Interchangeable Built-In Dual Colour Lamps

Compact but powerful 360° LED Warning Light Bars. Medium profile.

LED WARNING LIGHT BARS  
BARRE DE FEUX D'AVERTISSEUR DEL



| Part No.        | Colour         | Connection    |
|-----------------|----------------|---------------|
| <b>E-7211AB</b> | Amber or Blue  | 6x Lead Wires |
| <b>E-7211AW</b> | Amber or White | 6x Lead Wires |

#### FEATURES & BENEFITS

- Synchronize up to 8 units easily with dedicated sync wire
- Synchronize with E-728 & E-725 series
- 4 Flash Patterns per colour (includes Rotating)

#### ACCESSORIES

- F-S9805** Fuse/Switch Kit
- E-F227** Replacement Brackets (sold in pairs)

|                |                               |
|----------------|-------------------------------|
| Mounting       | Double Bracket Mount          |
| Lens Colour    | Clear                         |
| LED            | 72 x 1W                       |
| Flash Patterns | 4 Patterns                    |
| Voltage        | 12V - 24V                     |
| Amp Draw       | 1.0 @ 12V                     |
| SAE            | SAE J845 Class 2 on 2 Flashes |
| Housing        | ABS Base                      |
| Lens           | Polycarbonate                 |
| IP Rating      | IP65                          |
| EMC            | Certified                     |
| RoHS           | -                             |
| Dimensions     | 11" L x 6.75" W x 2.5" H      |



| Part No.        | Colour         | Connection    |
|-----------------|----------------|---------------|
| <b>E-7212AB</b> | Amber or Blue  | 6x Lead Wires |
| <b>E-7212AW</b> | Amber or White | 6x Lead Wires |

#### FEATURES & BENEFITS

- Synchronize up to 6 units easily with dedicated sync wire
- 10 Flash Patterns per colour (includes Rotating & Steady)

#### ACCESSORIES

- F-S9805** Fuse/Switch Kit

|                |                               |
|----------------|-------------------------------|
| Mounting       | Single Bolt Mount             |
| Lens Colour    | Clear                         |
| LED            | 60 x 1.5W                     |
| Flash Patterns | 10 Patterns                   |
| Voltage        | 12V - 24V                     |
| Amp Draw       | 5.58 @ 12V                    |
| SAE            | SAE J845 Class 1 on 8 Flashes |
| Housing        | ABS Base                      |
| Lens           | Polycarbonate                 |
| IP Rating      | IP67                          |
| EMC            | Certified                     |
| RoHS           | -                             |
| Dimensions     | 11.4" L x 6.75" W x 2" H      |

# 15" STANDARD - DUAL COLOUR

Interchangeable Built-In Dual Colour Lamps

Compact but powerful 360° LED Warning Light Bars. Medium profile.

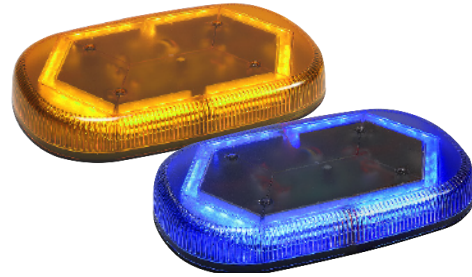

| Part No.        | Colour        | Connection    |
|-----------------|---------------|---------------|
| <b>E-7615AB</b> | Amber or Blue | 6x Lead Wires |

### FEATURES & BENEFITS

- Synchronize multiple units easily with dedicated sync wire
- Synchronize with E-763 & E-765 series
- Super Efficient Diodes for Low Amp Draw Applications
- 5 Flash Patterns per colour (includes Rotating)

### ACCESSORIES

**F-S9805** Fuse/Switch Kit

|                |                                      |
|----------------|--------------------------------------|
| Mounting       | Surface Mount (No Brackets Included) |
| Lens Colour    | Clear                                |
| LED            | 64 x 1W                              |
| Flash Patterns | 5 Patterns                           |
| Voltage        | 12V - 30V                            |
| Amp Draw       | 0.87 @ 12V                           |
| SAE            | SAE J845 Class 1 on 2 Flashes        |
| Housing        | ABS Base                             |
| Lens           | Polycarbonate                        |
| IP Rating      | IP65                                 |
| EMC            | Certified                            |
| RoHS           | -                                    |
| Dimensions     | 15" L x 9.5" W x 2" H                |

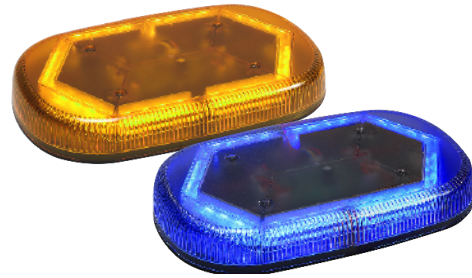

| Part No.        | Colour        | Connection    |
|-----------------|---------------|---------------|
| <b>E-7315AB</b> | Amber or Blue | 4x Lead Wires |

### FEATURES & BENEFITS

- Synchronize up to 10 units easily with dedicated sync wire
- Synchronize with E-736 & E-735 series
- 5 Flash Patterns per colour (includes Rotating)

### ACCESSORIES

**F-S9805** Fuse/Switch Kit

|                |  |
|----------------|--|
| Mounting       | Surface Mount (No Brackets Included)     |
| Lens Colour    | Clear                                    |
| LED            | 64 x 1W                                  |
| Flash Patterns | 7 Dual Colour & 5 Single Colour Patterns |
| Voltage        | 12V - 24V                                |
| Amp Draw       | 3.0 @ 12V                                |
| SAE            | SAE J845 Class 1 on 4 Flashes            |
| Housing        | ABS Base                                 |
| Lens           | Polycarbonate                            |
| IP Rating      | IP65                                     |
| EMC            | Certified                                |
| RoHS           | -  |
| Dimensions     | 15" L x 9.5" W x 2" H                    |

# OVER 17" STANDARD - DUAL COLOUR

Interchangeable Built-In Dual Colour Lamps

LED WARNING LIGHT BARS  
BARRE DE FEUX D'AVERTISSEUR DEL

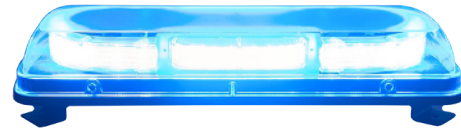

| Part No.        | Colour        | Connection    |
|-----------------|---------------|---------------|
| <b>E-7117AB</b> | Amber or Blue | 6x Lead Wires |

#### FEATURES & BENEFITS

- Synchronize up to 8 units easily with dedicated sync wire
- Synchronize with E-713 & E-7124 series
- 4 Flash Patterns per colour (includes Rotating)

#### ACCESSORIES

- F-S9805** Fuse/Switch Kit
- E-F227** Replacement Brackets (sold in pairs)

|                |                               |
|----------------|-------------------------------|
| Mounting       | Double Bracket Mount          |
| Lens Colour    | Clear                         |
| LED            | 108 x 1W                      |
| Flash Patterns | 4 Patterns                    |
| Voltage        | 12V - 24V                     |
| Amp Draw       | 2.2 @ 12V                     |
| SAE            | SAE J845 Class 1 on 2 Flashes |
| Housing        | Polycarbonate Base            |
| Lens           | Polycarbonate                 |
| IP Rating      | IP65                          |
| EMC            | Certified                     |
| RoHS           | -                             |
| Dimensions     | 17.5" L x 7.25" W x 2.5" H    |



| Part No.        | Colour         | Connection    |
|-----------------|----------------|---------------|
| <b>E-2350AW</b> | Amber or White | 2x Lead Wires |

#### FEATURES & BENEFITS

- 28 Flash Patterns (includes Rotating)
- 14 ft wire from controller to light
- 9.5 ft power cable from light to vehicle
- Mounting Hardware & Control Box included

|                |                               |
|----------------|-------------------------------|
| Mounting       | Double Bracket Mount          |
| Lens Colour    | Clear                         |
| LED            | 360 x 1W                      |
| Flash Patterns | 28 Patterns                   |
| Voltage        | 12V - 24V                     |
| Amp Draw       | 2.2 @ 12V                     |
| SAE            | SAE J845 Class 1 on 2 Flashes |
| Housing        | Polycarbonate Top             |
| Lens           | Polycarbonate                 |
| CISPR25 Rating | Class 3                       |
| IP Rating      | IP66                          |
| EMC            | Certified                     |
| RoHS           | -                             |
| Dimensions     | 35" L x 7.25" W x 2.5" H      |



# OVER 16" - SPLIT COLOUR

Half & Half Colour Splits

Compact but powerful 360° LED Warning Light Bars.

**E-2161AB**



**E-2161ABM**



| Part No.         | Mounting               | Connection                            |
|------------------|------------------------|---------------------------------------|
| <b>E-2161AB</b>  | Double Bracket Mount   | 4x Lead Wires                         |
| <b>E-2161ABM</b> | Magnetic Suction Mount | 10ft Cigarette Adaptor w/ Dual Switch |

|                |                           |
|----------------|---------------------------|
| LED Colour     | Half Amber - Half Blue    |
| Lens Colour    | Clear                     |
| LED            | 18 x 1W                   |
| Flash Patterns | 19 Patterns               |
| Voltage        | 12V                       |
| Amp Draw       | 3.1 @ 12V                 |
| SAE            | -                         |
| Housing        | Polycarbonate Base        |
| Lens           | Polycarbonate             |
| IP Rating      | IP64K                     |
| EMC            | Certified                 |
| RoHS           | -                         |
| Dimensions     | 16.63" L x 6.38" W x 3" H |

### FEATURES & BENEFITS

- Synchronize up to 4 units easily with dedicated sync wire
- 19 Flash Patterns (includes Steady Light)
- Dimming Function capable

### ACCESSORIES

- F-S958** Fuse/Switch Kit for E-2163A & E-2163AC
- E-F216** Replacement Double Brackets (sold in pairs)



| Part No.         | Mounting               | Connection                                       |
|------------------|------------------------|--|
| <b>E-2232AWM</b> | Magnetic Suction Mount | 12.5ft Cigarette Adaptor w/ Single Button Switch |

|                |                           |
|----------------|---------------------------|
| LED Colour     | Half Amber - Half White   |
| Lens Colour    | Clear                     |
| LED            | 40 x 1W                   |
| Flash Patterns | 12 Patterns               |
| Voltage        | 12V - 30V                 |
| Amp Draw       | 1.7 @ 12V                 |
| SAE            | -                         |
| Housing        | Aluminum Top & Bottom     |
| Lens           | Polycarbonate             |
| IP Rating      | IP65                      |
| EMC            | Certified                 |
| RoHS           | -                         |
| Dimensions     | 23" L x 3.69" W x 1.44" H |

### FEATURES & BENEFITS

- 12 Flash Patterns (includes Steady Light)

### ACCESSORIES

- F-S976** Fuse/Switch Kit for E-2223AC
- E-F223** Replacement Brackets (sold in pairs)



# LED WARNING LIGHT STICKS

SAE Class 1

Single face LED warning sticks designed for Utility Vehicles. Controller included.

LED WARNING LIGHT STICK & ARROW SETS  
AVERTISSEUR LUMINEUX DEL - BARRE ET FLÈCHES



**E-7124AB-1**



**E-7124AA**



| Part No.          | Colour       | Dimensions            |
|-------------------|--------------|-----------------------|
| <b>E-7124AB-1</b> | Amber & Blue | 25" L x 1.5" W x 2" H |
| <b>E-7124AA</b>   | Amber        | 25" L x 1.5" W x 2" H |

#### FEATURES & BENEFITS

- Synchronize up to 8 units easily with dedicated sync wire
- Synchronize with E-713 & E-7117 series
- 6 Flash Patterns per colour

#### ACCESSORIES

**F-S9805** Fuse/Switch Kit

|                |                                  |
|----------------|----------------------------------|
| Mounting       | Side Bracket Mount               |
| Lens Colour    | Clear                            |
| LED            | 2x Amber Module & 2x Blue Module |
| Flash Patterns | 6 Patterns                       |
| Voltage        | 12V - 24V                        |
| Amp Draw       | 2.2 @ 12V                        |
| SAE            | SAE J595 Class 1 on 2 Flashes    |
| Housing        | Aluminum                         |
| Lens           | Polycarbonate                    |
| IP Rating      | IP65                             |
| EMC            | Certified                        |
| RoHS           | -                                |
| Connection     | 6x Lead Wires                    |



| Part No.        | LED             | Dimensions            |
|-----------------|-----------------|-----------------------|
| <b>E-2942AC</b> | 8 Amber Modules | 42" L x 2" H x 2.5" D |

#### FEATURES & BENEFITS

- 8 Flash Patterns (includes Directional)
- 12.75 ft wire from controller to light
- 10" power cable from controller to vehicle
- Mounting Hardware & Control Box included

#### ACCESSORIES

**F-S976** Fuse/Switch Kit  
**E-F300** 25 ft Extension w/ Connectors  
**E-F301** 50 ft Extension w/ Connectors  
**E-F292** Replacement "L" Bracket  
**E-F293** Replacement "T" Bracket

|                |                               |
|----------------|-------------------------------|
| Mounting       | "L" / "T" Brackets            |
| Lens Colour    | Clear                         |
| LED            | Amber                         |
| Flash Patterns | 8 Patterns                    |
| Voltage        | 12V - 24V                     |
| Amp Draw       | 7.59 @ 12V                    |
| SAE            | SAE J845 Class 1 on 2 Flashes |
| Housing        | Aluminum                      |
| Lens           | Polycarbonate                 |
| IP Rating      | IP67                          |
| EMC            | Certified                     |
| RoHS           | -                             |
| Connection     | 2x Lead Wires                 |

# LED WARNING LIGHT STICKS - SLIM LINE

SAE Class 1

Single face LED warning sticks designed for Utility Vehicles. Controller included.



| Part No.         | LED        | Dimensions             |
|------------------|------------|------------------------|
| <b>E-26409AC</b> | 96 x 0.25W | 40" L x 1" H x 2.18" D |

#### FEATURES & BENEFITS

- 7 Flash Patterns (includes Directional)
- 12.75 ft wire from controller to light
- 10" power cable from controller to vehicle
- Mounting Hardware & Controller included

#### ACCESSORIES

- F-S976** Fuse/Switch Kit
- E-F300** 25 ft Extension w/ Connectors
- E-F301** 50 ft Extension w/ Connectors
- E-F292** Replacement "L" Bracket
- E-F293** Replacement "T" Bracket

|                |                               |
|----------------|-------------------------------|
| Mounting       | "L" / "T" Brackets            |
| Lens Colour    | Clear                         |
| LED            | Amber                         |
| Flash Patterns | 7 Patterns                    |
| Voltage        | 12V - 24V                     |
| Amp Draw       | 5.0 @ 12V                     |
| SAE            | SAE J845 Class 1 on 2 Flashes |
| Housing        | Aluminum                      |
| Lens           | Polycarbonate                 |
| IP Rating      | IP69K                         |
| EMC            | Certified                     |
| RoHS           | Certified                     |
| Connection     | 2x Lead Wires                 |

**SAE Class 1, Class 2 or Class 3?** Not sure what to use on your application?

## Class 1 Optical Warning Device

is a primary optical warning device for use on authorized emergency vehicles responding to emergency situations. These devices are utilized to capture the attention of motorists and pedestrians to warn them of a potentially hazardous activity or situation. Examples of emergency vehicles are police vehicles, fire trucks and ambulances.

## Class 2 Optical Warning Device

is a primary optical warning device for use on authorized maintenance or service vehicles to warn others of traffic hazards such as a lane blockage or slow moving vehicle. Examples of maintenance or service vehicles are tow trucks, snow plow vehicles, Department of Highway Road maintenance vehicles and other slow moving vehicles.

## Class 3 Optical Warning Device

is a primary optical warning device for use on vehicles authorized to display an optical warning device for identification only.

# LED WARNING LIGHT ARROWS

SAE Class 1

Traffic directing made easy with the E-2900 series LED traffic warning light stick and arrow sets. This series is perfect for use at construction sites, road work and hazardous areas. High power LED diodes ensure greater visibility and increases safety. Advanced tech improves on the fluidity of the LED arrows. Controller included.

LED WARNING LIGHT STICK & ARROW SETS  
AVERTISSEUR LUMINEUX DEL - BARRE ET FLÈCHES

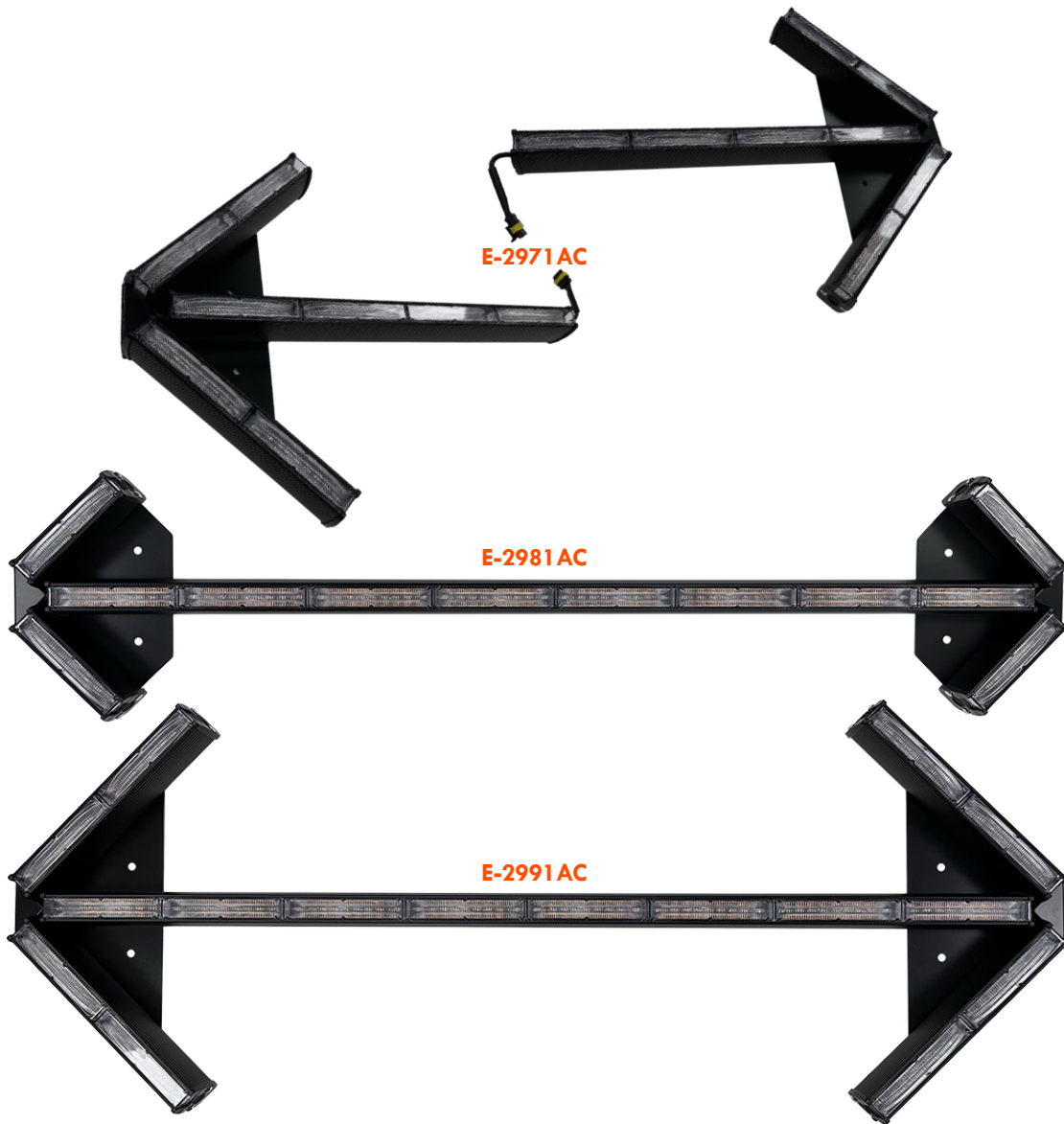

| Part No.         | LED              | Dimensions               |
|------------------|------------------|--------------------------|
| <b>E-2971 AC</b> | 16 Amber Modules | 34" L x 17.7" H x 2.5" D |
| <b>E-2981 AC</b> | 12 Amber Modules | 45" L x 10.5" H x 2.5" D |
| <b>E-2991 AC</b> | 16 Amber Modules | 45" L x 17.7" H x 2.5" D |

## FEATURES & BENEFITS

- This unit is split into 2 separate arrows
- 8 Flash Patterns (includes Directional)
- 12.75 ft wire from controller to light
- 10" power cable from controller to vehicle
- Mounting Hardware & Control Box included

## ACCESSORIES

- F-S976** Fuse/Switch Kit
- E-F300** 25 ft Extension w/ Connectors
- E-F301** 50 ft Extension w/ Connectors
- E-F292** Replacement "L" Bracket
- E-F293** Replacement "T" Bracket

|                |                               |
|----------------|-------------------------------|
| Mounting       | "L" / "T" Brackets            |
| Lens Colour    | Clear                         |
| Colour         | Amber                         |
| Flash Patterns | 8 Patterns                    |
| Voltage        | 12V - 24V                     |
| Amp Draw       | 7.59 @ 12V                    |
| SAE            | SAE J845 Class 1 on 2 Flashes |
| Housing        | Aluminum                      |
| Lens           | Polycarbonate                 |
| IP Rating      | IP67                          |
| EMC            | Certified                     |
| RoHS           | -                             |
| Connection     | 2x Lead Wires                 |

# HIGH DURABILITY BEACONS

SAE Class 1 / SAE Class 2



| Part No.      | Mounting      | Connection    |
|---------------|---------------|---------------|
| <b>E-890A</b> | Surface Mount | 3x Lead Wires |

|                |                             |
|----------------|-----------------------------|
| LED Colour     | Amber                       |
| Lens Colour    | Amber                       |
| LED            | (24 x 1W) + (48 x 0.5W)     |
| Flash Patterns | 6 Patterns                  |
| Voltage        | 12V - 36V                   |
| Amp Draw       | 4.9 @ 12V                   |
| SAE            | SAE J845 Class 1 on 1 Flash |
| Housing        | Aluminum Base               |
| Lens           | Polycarbonate               |
| IP Rating      | IP67                        |
| EMC            | Certified                   |
| RoHS           | -                           |
| Dimensions     | 7.88" H x 8.63" Base Dia.   |

#### FEATURES & BENEFITS

- High Durability Dome
- Mounting Options: 3.5" centre / 7" centre
- 6 Flash Patterns (includes Rotating Flash)

#### ACCESSORIES

- F-S955** Fuse/Switch Kit
- E-F680** Plate & Bracket Set for Pole Mount or Mirror Arm Mount

| Part No.      | Mounting      | Connection    |
|---------------|---------------|---------------|
| <b>E-890B</b> | Surface Mount | 3x Lead Wires |

|                |                             |
|----------------|-----------------------------|
| LED Colour     | Blue                        |
| Lens Colour    | Blue                        |
| LED            | (24 x 1W) + (48 x 0.5W)     |
| Flash Patterns | 6 Patterns                  |
| Voltage        | 12V - 36V                   |
| Amp Draw       | 4.9 @ 12V                   |
| SAE            | SAE J845 Class 2 on 1 Flash |
| Housing        | Aluminum Base               |
| Lens           | Polycarbonate               |
| IP Rating      | IP67                        |
| EMC            | Certified                   |
| RoHS           | -                           |
| Dimensions     | 7.88" H x 8.63" Base Dia.   |

#### FEATURES & BENEFITS

- High Durability Dome
- Mounting Options: 3.5" centre / 7" centre
- 6 Flash Patterns (includes Rotating Flash)

#### ACCESSORIES

- F-S955** Fuse/Switch Kit
- E-F680** Plate & Bracket Set for Pole Mount or Mirror Arm Mount

# HIGH DURABILITY BEACONS

SAE Class 1 / SAE Class 2

LED WARNING BEACONS  
FEUX DE BALISE D'AVERTISSEUR DEL



| Part No.       | Mounting      | Connection    |
|----------------|---------------|---------------|
| <b>E-888AC</b> | Surface Mount | 2x Lead Wires |

|                |                           |
|----------------|---------------------------|
| LED Colour     | Amber                     |
| Lens Colour    | Amber                     |
| LED            | 8 x 1W                    |
| Flash Patterns | Quad Flash                |
| Voltage        | 12V - 40V                 |
| Amp Draw       | 1.3 @ 12V                 |
| SAE            | SAE J845 Class 1          |
| Housing        | Aluminum Base             |
| Lens           | Polycarbonate             |
| IP Rating      | IP65                      |
| EMC            | -                         |
| RoHS           | -                         |
| Dimensions     | 7.88" H x 8.63" Base Dia. |

#### FEATURES & BENEFITS

- High Durability Clear Dome
- Mounting Options: 3.5" centre / 7" centre

#### ACCESSORIES

- F-S950** Fuse/Switch Kit
- E-F680** Plate & Bracket Set for Pole Mount or Mirror Arm Mount
- EC-880** Replacement Clear Dome
- CL-550A** Replacement Amber Lens

| Part No.       | Mounting      | Connection    |
|----------------|---------------|---------------|
| <b>E-882AC</b> | Surface Mount | 3x Lead Wires |

|                |                           |
|----------------|---------------------------|
| LED Colour     | Amber                     |
| Lens Colour    | Amber                     |
| LED            | 4 x 1W                    |
| Flash Patterns | Hexad (6 Flashes)         |
| Voltage        | 12V - 40V                 |
| Amp Draw       | 0.9 @ 12V                 |
| SAE            | SAE J845 Class 2          |
| Housing        | Aluminum Base             |
| Lens           | Polycarbonate             |
| IP Rating      | IP65                      |
| EMC            | -                         |
| RoHS           | -                         |
| Dimensions     | 7.88" H x 8.63" Base Dia. |

#### FEATURES & BENEFITS

- High Durability Clear Dome
- Mounting Options: 3.5" centre / 7" centre

#### ACCESSORIES

- F-S950** Fuse/Switch Kit
- E-F680** Plate & Bracket Set for Pole Mount or Mirror Arm Mount
- EC-880** Replacement Clear Dome
- CL-550A** Replacement Amber Lens

# MEDIUM PROFILE

SAE Class 2



| Part No.      | Mounting           | Connection    |
|---------------|--------------------|---------------|
| <b>E-661A</b> | Surface/Pole Mount | 2x Lead Wires |

|                |                           |
|----------------|---------------------------|
| LED Colour     | Amber                     |
| Lens Colour    | Amber                     |
| LED            | 8 x 1W                    |
| Flash Patterns | Quad Flash                |
| Voltage        | 12V - 110V                |
| Amp Draw       | 0.3 @ 12V                 |
| SAE            | SAE J845 Class 2          |
| Housing        | Polycarbonate Base        |
| Lens           | Polycarbonate             |
| IP Rating      | IP65                      |
| EMC            | Certified                 |
| RoHS           | Certified                 |
| Dimensions     | 6.25" H x 6.63" Base Dia. |

#### FEATURES & BENEFITS

- Supports up to 110V DC applications
- Mounting Options: 3 mounting holes @ 6" diameter / 1" NPT

#### ACCESSORIES

- F-S950** Fuse/Switch Kit
- E-F680** Plate & Bracket Set for Pole Mount or Mirror Arm Mount
- E-FM600** Magnet Mount Kit w/ Coiled Wire & Cigarette Adaptor

| Part No.      | Mounting      | Connection    |
|---------------|---------------|---------------|
| <b>E-650A</b> | Surface Mount | 2x Lead Wires |

|                |                       |
|----------------|-----------------------|
| LED Colour     | Amber                 |
| Lens Colour    | Amber                 |
| LED            | 8 x 2W                |
| Flash Patterns | Rotating Flash        |
| Voltage        | 12V - 40V             |
| Amp Draw       | 0.6 @ 12V             |
| SAE            | SAE J845 Class 2      |
| Housing        | ABS Base              |
| Lens           | Polycarbonate         |
| IP Rating      | IP65                  |
| EMC            | -                     |
| RoHS           | -                     |
| Dimensions     | 5" H x 6.5" Base Dia. |

#### FEATURES & BENEFITS

- Mounting Options: 3 mounting holes @ 6" diameter

#### ACCESSORIES

- F-S950** Fuse/Switch Kit
- E-F680** Plate & Bracket Set for Pole Mount or Mirror Arm Mount
- E-FM600** Magnet Mount Kit w/ Coiled Wire & Cigarette Adaptor



# MEDIUM PROFILE

SAE Class 2

LED WARNING BEACONS  
FEUX DE BALISE D'AVERTISSEUR DEL



| Part No.      | Mounting           | Connection    |
|---------------|--------------------|---------------|
| <b>E-551A</b> | Surface/Pole Mount | 2x Lead Wires |

|                |                        |
|----------------|------------------------|
| LED Colour     | Amber                  |
| Lens Colour    | Amber                  |
| LED            | 3 x 1W                 |
| Flash Patterns | Quad Flash             |
| Voltage        | 12V - 110V             |
| Amp Draw       | 0.3 @ 12V              |
| SAE            | SAE J845 Class 2       |
| Housing        | Polycarbonate Base     |
| Lens           | Polycarbonate          |
| IP Rating      | IP65                   |
| EMC            | Certified              |
| RoHS           | Certified              |
| Dimensions     | 5" H x 6.63" Base Dia. |

#### FEATURES & BENEFITS

- Supports up to 110V DC applications
- Mounting Options: 3 mounting holes @ 6" diameter / 1" NPT

#### ACCESSORIES

- F-S950** Fuse/Switch Kit
- E-F680** Plate & Bracket Set for Pole Mount or Mirror Arm Mount
- E-FM600** Magnet Mount Kit w/ Coiled Wire & Cigarette Adaptor

| Part No.      | Mounting           | Connection    |
|---------------|--------------------|---------------|
| <b>E-554B</b> | Surface/Pole Mount | 2x Lead Wires |

|                |                       |
|----------------|-----------------------|
| LED Colour     | Blue                  |
| Lens Colour    | Blue                  |
| LED            | 8 x 2W                |
| Flash Patterns | Hexad Flash           |
| Voltage        | 12V - 40V             |
| Amp Draw       | 0.5 @ 12V             |
| SAE            | SAE J845 Class 2      |
| Housing        | ABS Base              |
| Lens           | Polycarbonate         |
| IP Rating      | IP66                  |
| EMC            | -                     |
| RoHS           | -                     |
| Dimensions     | 5" H x 6.5" Base Dia. |

#### FEATURES & BENEFITS

- Mounting Options: 3 mounting holes @ 6" diameter / 1" NPT

#### ACCESSORIES

- F-S950** Fuse/Switch Kit
- E-F680** Plate & Bracket Set for Pole Mount or Mirror Arm Mount
- E-FM600** Magnet Mount Kit w/ Coiled Wire & Cigarette Adaptor

# MEDIUM PROFILE

SAE Class 1



| Part No.       | Mounting       | Connection                              |
|----------------|----------------|---|
| <b>E-556A</b>  | Surface Mount  | 3x Lead Wires                           |
| <b>E-556AM</b> | Magnetic Mount | 11.8ft Cigarette Adaptor w/ Dual Switch |

|                |                             |
|----------------|-----------------------------|
| LED Colour     | Amber                       |
| Lens Colour    | Amber                       |
| LED            | 8 x 3W                      |
| Flash Patterns | 6 Patterns                  |
| Voltage        | 12V - 24V                   |
| Amp Draw       | 1.0 @ 12V                   |
| SAE            | SAE J845 Class 1 on 1 Flash |
| Housing        | Polycarbonate Base          |
| Lens           | Polycarbonate               |
| IP Rating      | IP65                        |
| EMC            | Certified                   |
| RoHS           | -                           |
| Dimensions     | 5" H x 6.63" Base Dia.      |

#### FEATURES & BENEFITS

- Mounting Options: 3 mounting holes @ 6" diameter

#### ACCESSORIES

- F-S950** Fuse/Switch Kit
- E-F680** Plate & Bracket Set for Pole Mount or Mirror Arm Mount
- E-FM600** Magnet Mount Kit w/ Coiled Wire & Cigarette Adaptor

| Part No.       | Mounting               | Connection                           |
|----------------|------------------------|--------------------------------------|
| <b>E-557A</b>  | Surface/Pole Mount     | 3x Lead Wires                        |
| <b>E-557AM</b> | Magnetic Suction Mount | 5ft Cigarette Adaptor w/ Dual Switch |

|                |                             |
|----------------|-----------------------------|
| LED Colour     | Amber                       |
| Lens Colour    | Amber                       |
| LED            | 48 x 1W                     |
| Flash Patterns | 6 Patterns                  |
| Voltage        | 12V - 48V                   |
| Amp Draw       | 1.5 @ 12V                   |
| SAE            | SAE J845 Class 1 on 1 Flash |
| Housing        | Aluminum Base               |
| Lens           | Polycarbonate               |
| IP Rating      | IP67                        |
| EMC            | Certified                   |
| RoHS           | -                           |
| Dimensions     | 4.65" H x 6.63" Base Dia.   |

#### FEATURES & BENEFITS

- Mounting Options: 3 mounting holes @ 6" diameter / 1" NPT

#### ACCESSORIES

- F-S950** Fuse/Switch Kit
- E-F680** Plate & Bracket Set for Pole Mount or Mirror Arm Mount
- E-FM600** Magnet Mount Kit w/ Coiled Wire & Cigarette Adaptor

# MEDIUM PROFILE

SAE Class 1 / SAE Class 2

LED WARNING BEACONS  
FEUX DE BALISE D'AVERTISSEUR DEL



| Part No.      | Mounting      | Connection    |
|---------------|---------------|---------------|
| <b>E-250A</b> | Surface Mount | 2x Lead Wires |

|                |                                |
|----------------|--------------------------------|
| LED Colour     | Amber                          |
| Lens Colour    | Amber                          |
| LED            | 3 x 1W                         |
| Flash Patterns | 1 Pattern (8-Flash)            |
| Voltage        | 12V - 110V                     |
| Amp Draw       | 0.5 @ 12V                      |
| SAE            | SAE J845 Class 2               |
| Housing        | Polycarbonate Base             |
| Lens           | Polycarbonate                  |
| IP Rating      | IP64                           |
| EMC            | Certified                      |
| RoHS           | -                              |
| Dimensions     | 5.13" H x (2.88" x 3.88") Base |

#### FEATURES & BENEFITS

- Supports up to 110V DC applications
- Mounting Options: 2 mounting holes @ 3.38" centres

#### ACCESSORIES

**F-S950** Fuse/Switch Kit

| Part No.      | Mounting           | Connection    |
|---------------|--------------------|---------------|
| <b>E-540A</b> | Surface/Pole Mount | 3x Lead Wires |

|                |                             |
|----------------|-----------------------------|
| LED Colour     | Amber                       |
| Lens Colour    | Amber                       |
| LED            | 12 x 2W                     |
| Flash Patterns | 6 Patterns                  |
| Voltage        | 12V - 24V                   |
| Amp Draw       | 2.5 @ 12V                   |
| SAE            | SAE J845 Class 1 on 1 Flash |
| Housing        | Aluminum Base               |
| Lens           | Polycarbonate               |
| IP Rating      | IP66                        |
| EMC            | -                           |
| RoHS           | -                           |
| Dimensions     | 4.5" H x 6.5" Base Dia.     |

#### FEATURES & BENEFITS

- High Durability Aluminum Base
- Mounting Options: 3 mounting holes @ 6" diameter / 1" NPT

#### ACCESSORIES

**F-S950** Fuse/Switch Kit

**E-F680** Plate & Bracket Set for Pole Mount or Mirror Arm Mount

**E-FM600** Magnet Mount Kit w/ Coiled Wire & Cigarette Adaptor

# SHORT PROFILE

SAE Class 1



| Part No.      | Lens Colour | LED Colour |
|---------------|-------------|------------|
| <b>E-333A</b> | Amber       | White      |
| <b>E-333B</b> | Blue        | White      |
| <b>E-333R</b> | Red         | White      |
| <b>E-333W</b> | White       | White      |

| Part No.       | Lens Colour | LED Colour |
|----------------|-------------|------------|
| <b>E-333AM</b> | Amber       | White      |
| <b>E-333BM</b> | Blue        | White      |

|                |                             |
|----------------|-----------------------------|
| Mounting       | Surface Mount               |
| LED            | 32 x 0.2W                   |
| Flash Patterns | 6 Patterns                  |
| Voltage        | 9V - 30V                    |
| Amp Draw       | 0.2 @ 12V                   |
| SAE            | SAE J845 Class 1 on 1 Flash |
| Housing        | Polycarbonate Base          |
| Lens           | Polycarbonate               |
| IP Rating      | IP66                        |
| EMC            | Certified                   |
| RoHS           | -                           |
| Dimensions     | 3.75" H x 5" Base Dia.      |
| Connection     | 3x Lead Wires               |

|                |                                       |
|----------------|---------------------------------------|
| Mounting       | Magnetic Mount                        |
| LED            | 32 x 0.2W                             |
| Flash Patterns | 6 Patterns                            |
| Voltage        | 9V - 30V                              |
| Amp Draw       | 0.2 @ 12V                             |
| SAE            | SAE J845 Class 1 on 1 Flash           |
| Housing        | Polycarbonate Base                    |
| Lens           | Polycarbonate                         |
| IP Rating      | IP66                                  |
| EMC            | Certified                             |
| RoHS           | -                                     |
| Dimensions     | 3.75" H x 5" Base Dia.                |
| Connection     | 12ft Cigarette Adaptor w/ Dual Switch |

## FEATURES & BENEFITS

- Interchangeable Lens allows for multiple application
- Mounting Options: 3 mounting holes @ 4.75" diameter

## ACCESSORIES

- F-S955** Fuse/Switch Kit
  - E-F680** Plate & Bracket Set for Pole Mount or Mirror Arm Mount
- For Different Coloured Lens, contact your distributor

## FEATURES & BENEFITS

- Interchangeable Lens allows for multiple application

## ACCESSORIES

- F-S955** Fuse/Switch Kit
  - E-F680** Plate & Bracket Set for Pole Mount or Mirror Arm Mount
- For Different Coloured Lens, contact your distributor

# DUAL COLOUR

Interchangeable Built-In Dual Colour Lamps

LED WARNING BEACONS  
FEUX DE BALISE D'AVERTISSEUR DEL



| Part No.       | Colour         | Connection    |
|----------------|----------------|---------------|
| <b>E-728AB</b> | Amber or Blue  | 6x Lead Wires |
| <b>E-728AW</b> | Amber or White | 6x Lead Wires |

|                |                               |
|----------------|-------------------------------|
| Mounting       | Surface/Pole Mount            |
| Lens Colour    | Clear                         |
| LED            | 16 x 1W                       |
| Flash Patterns | 4 Patterns                    |
| Voltage        | 12V - 24V                     |
| Amp Draw       | 0.7 @ 12V                     |
| SAE            | SAE J845 Class 2 on 2 Flashes |
| Housing        | ABS Base                      |
| Lens           | Polycarbonate                 |
| IP Rating      | IP65                          |
| EMC            | Certified                     |
| RoHS           | -                             |
| Dimensions     | 6.75" H x 6.5" Base Dia.      |

#### FEATURES & BENEFITS

- Synchronize up to 8 units easily with dedicated sync wire
- Synchronize with E-7211 & E-725 series
- 4 Flash Patterns per colour (includes Rotating)
- Mounting Options: 3 mounting holes @ 6" diameter / 1" NPT

#### ACCESSORIES

- F-S9805** Fuse/Switch Kit
- E-F680** Plate & Bracket Set for Pole Mount or Mirror Arm Mount
- E-FM600** Magnet Mount Kit w/ Coiled Wire & Cigarette Adaptor

| Part No.       | Colour        | Connection    |
|----------------|---------------|---------------|
| <b>E-736AB</b> | Amber or Blue | 4x Lead Wires |

|                |  |
|----------------|--|
| Mounting       | Surface/Pole Mount                       |
| Lens Colour    | Clear                                    |
| LED            | 24 x 1W                                  |
| Flash Patterns | 7 Dual Colour & 5 Single Colour Patterns |
| Voltage        | 12V - 24V                                |
| Amp Draw       | 2.0 @ 12V                                |
| SAE            | SAE J845 Class 1 on 4 Flashes            |
| Housing        | ABS Base                                 |
| Lens           | Polycarbonate                            |
| IP Rating      | IP65                                     |
| EMC            | Certified                                |
| RoHS           | -  |
| Dimensions     | 6.5" H x 6.5" Base Dia.                  |

#### FEATURES & BENEFITS

- Synchronize up to 10 units easily with dedicated sync wire
- Synchronize with E-7315 & E-735 series
- 5 Flash Patterns per colour (includes Rotating)
- Mounting Options: 3 mounting holes @ 6" diameter / 1" NPT

#### ACCESSORIES

- F-S9805** Fuse/Switch Kit
- E-F680** Plate & Bracket Set for Pole Mount or Mirror Arm Mount
- E-FM600** Magnet Mount Kit w/ Coiled Wire & Cigarette Adaptor

# DUAL COLOUR

Interchangeable Built-In Dual Colour Lamps



| Part No.       | Colour        | Connection    |
|----------------|---------------|---------------|
| <b>E-713AB</b> | Amber or Blue | 6x Lead Wires |

|                |                               |
|----------------|-------------------------------|
| Mounting       | Surface Mount                 |
| Lens Colour    | Clear                         |
| LED            | 16 x 1W                       |
| Flash Patterns | 4 Patterns                    |
| Voltage        | 12V - 24V                     |
| Amp Draw       | 0.6 @ 12V                     |
| SAE            | SAE J845 Class 1 on 2 Flashes |
| Housing        | Polycarbonate Base            |
| Lens           | Polycarbonate                 |
| IP Rating      | IP65                          |
| EMC            | Certified                     |
| RoHS           | -                             |
| Dimensions     | 3.38" H x 6.63" Base Dia.     |

#### FEATURES & BENEFITS

- Synchronize up to 8 units easily with dedicated sync wire
- Synchronize with E-7117 & E-7124 series
- 4 Flash Patterns per colour (includes Rotating)
- Mounting Options: 3 mounting holes @ 6.19" diameter

#### ACCESSORIES

- F-S9805** Fuse/Switch Kit
- E-FM600** Magnet Mount Kit w/ Coiled Wire & Cigarette Adaptor

| Part No.       | Colour        | Connection    |
|----------------|---------------|---------------|
| <b>E-763AB</b> | Amber or Blue | 6x Lead Wires |

|                |                               |
|----------------|-------------------------------|
| Mounting       | Surface Mount                 |
| Lens Colour    | Clear                         |
| LED            | 24 x 3W                       |
| Flash Patterns | 5 Patterns                    |
| Voltage        | 12V - 36V                     |
| Amp Draw       | 0.73 @ 12V                    |
| SAE            | SAE J845 Class 1 on 2 Flashes |
| Housing        | ABS Base                      |
| Lens           | Polycarbonate                 |
| IP Rating      | IP65                          |
| EMC            | Certified                     |
| RoHS           | -                             |
| Dimensions     | 3.88" H x 6.5" Base Dia.      |

#### FEATURES & BENEFITS

- Synchronize multiple units easily with dedicated sync wire
- Synchronize with E-7615 & E-765 series
- Super Efficient Diodes for Low Amp Draw Applications
- 5 Flash Patterns per colour (includes Rotating)
- Mounting Options: 3 mounting holes @ 6" diameter

#### ACCESSORIES

- F-S9805** Fuse/Switch Kit
- E-F680** Plate & Bracket Set for Pole Mount or Mirror Arm Mount
- E-FM600** Magnet Mount Kit w/ Coiled Wire & Cigarette Adaptor



# LOW PROFILE

SAE Class 1 / SAE Class 2

LED WARNING BEACONS  
FEUX DE BALISE D'AVERTISSEUR DEL



| Part No.       | Mounting       | Connection                                    |
|----------------|----------------|---|
| <b>E-530A</b>  | Surface Mount  | 2x Lead Wires                                 |
| <b>E-530AM</b> | Magnetic Mount | 8ft Cigarette Adaptor w/ Single Button Switch |

|                |                                 |
|----------------|---------------------------------|
| LED Colour     | Amber                           |
| Lens Colour    | Amber                           |
| LED            | 3 x 1W                          |
| Flash Patterns | 5 Patterns                      |
| Voltage        | 12V - 110V                      |
| Amp Draw       | 0.5 @ 12V                       |
| SAE            | SAE J845 Class 2 on All Flashes |
| Housing        | Polycarbonate Base              |
| Lens           | Polycarbonate                   |
| IP Rating      | IP65                            |
| EMC            | Certified                       |
| RoHS           | Certified                       |
| Dimensions     | 3.25" H x 5.63" Base Dia.       |

#### FEATURES & BENEFITS

- Built-In Pattern Selection Switch
- Supports up to 110V DC applications
- Mounting Options: 3 mounting holes @ 5.31" diameter

#### ACCESSORIES

- F-S950** Fuse/Switch Kit
- E-F680** Plate & Bracket Set for Pole Mount or Mirror Arm Mount

| Part No.       | Mounting      | Lens Colour |
|----------------|---------------|-------------|
| <b>E-230A</b>  | Surface Mount | Amber       |
| <b>E-230W</b>  | Surface Mount | Clear       |
| <b>E-230AD</b> | DIN Mount     | Amber       |

|                |                             |
|----------------|-----------------------------|
| LED Colour     | White                       |
| LED            | 32 x 0.5W                   |
| Flash Patterns | 3 Patterns                  |
| Voltage        | 10V - 30V                   |
| Amp Draw       | 1.0 @ 12V                   |
| SAE            | SAE J845 Class 1 on 1 Flash |
| Housing        | Polycarbonate Base          |
| Lens           | Polycarbonate               |
| IP Rating      | IP69K                       |
| EMC            | Certified                   |
| RoHS           | -                           |
| Dimensions     | 2" H x 4.38" Base Dia.      |
| Connection     | 3x Lead Wires               |

#### FEATURES & BENEFITS

- DIN Mount Version uses a built-in waterproof switch
- Surface Mounting Options: 3 mounting holes @ 6" diameter

#### ACCESSORIES

- F-S950** Fuse/Switch Kit
- E-F680** Plate & Bracket Set for Pole Mount or Mirror Arm Mount
- DIN020** DIN Mount Adaptor w/ 2x Lead Wires



DIN020

# BATTERY OPERATED

**E-480AM**



**E-480BM**



**E-480AB**



| Part No.       | Mounting             | Colour |
|----------------|----------------------|--------|
| <b>E-480AM</b> | Magnetic Mount       | Amber  |
| <b>E-480BM</b> | Magnetic Mount       | Blue   |
| <b>E-480AB</b> | Single Bracket Mount | Amber  |

|                |                       |
|----------------|-----------------------|
| LED            | 3 x 1W                |
| Flash Patterns | 1 Pattern - Rotating  |
| Battery Type   | 4x AA (not included)  |
| Housing        | Polycarbonate Base    |
| Lens           | Polycarbonate         |
| EMC            | Certified             |
| Dimensions     | 4.5" H x 5" Base Dia. |

**FEATURES & BENEFITS**

- Built-In Pattern Selection Switch



| Part No.       | Mounting       | Colour |
|----------------|----------------|--------|
| <b>E-460AM</b> | Magnetic Mount | Amber  |

**FEATURES & BENEFITS**

- Built-In Pattern Selection Switch
- Photocell Switch: Allows a built-in sensor to detect the surrounding environment and will turn ON in the dark automatically if photocell switch is "ON"

|                |                       |
|----------------|-----------------------|
| LED            | 15 x 1W               |
| Flash Patterns | Quad Flash            |
| Battery Type   | 2x D (not included)   |
| Housing        | ABS Base              |
| Lens           | Polycarbonate         |
| EMC            | -                     |
| Dimensions     | 4.5" H x 4" Base Dia. |



| Part No.       | Mounting       | Colour |
|----------------|----------------|--------|
| <b>E-438AM</b> | Magnetic Mount | Amber  |

**FEATURES & BENEFITS**

- Built-In Pattern Selection Switch

|                |                         |
|----------------|-------------------------|
| LED            | 15 x 1W                 |
| Flash Patterns | Double Flash / Rotating |
| Battery Type   | 4x AA (not included)    |
| Housing        | Polycarbonate Base      |
| Lens           | Polycarbonate           |
| EMC            | Certified               |
| Dimensions     | 4" H x 4" Base Dia.     |

# DUAL COLOUR

Interchangeable Built-In Dual Colour Lamps

SURFACE MOUNT LED DIRECTIONALS  
DIRECTIONNELS DEL À MONTAGE EN SURFACE



| Part No.       | Colour         | Connection    |
|----------------|----------------|---------------|
| <b>E-725AB</b> | Amber or Blue  | 6x Lead Wires |
| <b>E-725AW</b> | Amber or White | 6x Lead Wires |

### FEATURES & BENEFITS

- Synchronize up to 8 units easily with dedicated sync wire
- Synchronize with E-7211 & E-728 series
- 4 Flash Patterns per colour (includes Rotating)
- Mounting Options: 2 mounting holes @ 5.5" diameter

### ACCESSORIES

**F-S9805** Fuse/Switch Kit

|                |                               |
|----------------|-------------------------------|
| Mounting       | Surface Mount                 |
| Lens Colour    | Clear                         |
| LED            | 18 x 1W                       |
| Flash Patterns | 4 Patterns                    |
| Voltage        | 12V - 24V                     |
| Amp Draw       | 0.5 @ 12V                     |
| SAE            | SAE J845 Class 1 on 2 Flashes |
| Housing        | Aluminum                      |
| Lens           | Polycarbonate                 |
| IP Rating      | IP65                          |
| EMC            | Certified                     |
| RoHS           | -                             |
| Dimensions     | 6" L x 1.38" W x 1.25" D      |



| Part No.       | Colour         | Connection    |
|----------------|----------------|---------------|
| <b>E-735AB</b> | Amber or Blue  | 4x Lead Wires |
| <b>E-735AW</b> | Amber or White | 4x Lead Wires |

### FEATURES & BENEFITS

- Synchronize up to 10 units easily with dedicated sync wire
- Synchronize with E-7315 & E-736 series
- 5 Flash Patterns per colour (includes Rotating)
- Mounting Options: 2 mounting holes @ 5" diameter

### ACCESSORIES

**F-S955** Fuse/Switch Kit

|                |  |
|----------------|--|
| Mounting       | Surface Mount                            |
| Lens Colour    | Clear                                    |
| LED            | 12 x 1W                                  |
| Flash Patterns | 7 Dual Colour & 5 Single Colour Patterns |
| Voltage        | 12V - 24V                                |
| Amp Draw       | 0.7 @ 12V                                |
| SAE            | SAE J845 Class 1 on 4 Flashes            |
| Housing        | Aluminum                                 |
| Lens           | Polycarbonate                            |
| IP Rating      | IP67                                     |
| EMC            | Certified                                |
| RoHS           | -  |
| Dimensions     | 5.31" L x 1.25" W x 0.56" D              |

# DUAL COLOUR

Interchangeable Built-In Dual Colour Lamps



| Part No.       | Colour        | Connection    |
|----------------|---------------|---------------|
| <b>E-765AB</b> | Amber or Blue | 6x Lead Wires |

### FEATURES & BENEFITS

- Synchronize multiple units easily with dedicated sync wire
- Synchronize with E-7615 & E-763 series
- Super Efficient Diodes for Low Amp Draw Applications
- 5 Flash Patterns per colour (includes Rotating)
- Mounting Options: 2 mounting holes @ 5" diameter

### ACCESSORIES

- F-S9805** Fuse/Switch Kit
- E-F680** Plate & Bracket Set for Pole Mount or Mirror Arm Mount
- E-FM600** Magnet Mount Kit w/ Coiled Wire & Cigarette Adaptor

|                |                               |
|----------------|-------------------------------|
| Mounting       | Surface Mount                 |
| Lens Colour    | Clear                         |
| LED            | 12 x 1W                       |
| Flash Patterns | 5 Patterns                    |
| Voltage        | 12V - 24V                     |
| Amp Draw       | 0.59 @ 12V                    |
| SAE            | SAE J845 Class 1 on 2 Flashes |
| Housing        | Aluminum                      |
| Lens           | Polycarbonate                 |
| IP Rating      | IP65                          |
| EMC            | Certified                     |
| RoHS           | -                             |
| Dimensions     | 5.31" L x 1.25" W x 0.56" D   |

## Steel Mounting Pad for aluminum / non-metal cabs

| Part No.        | Material               | Qty   |
|-----------------|------------------------|-------|
| <b>MM3030</b>   | 3 Ga Steel - 3mm thick | 1 pc  |
| <b>MM3030-2</b> | 3 Ga Steel - 3mm thick | 2 pcs |

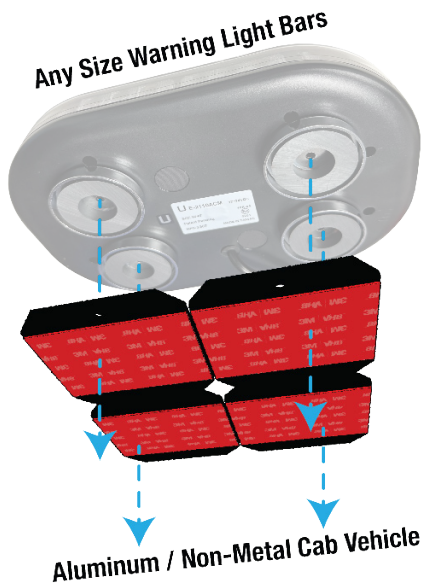

**Works with most Uni-Bond Magnetic Warning Lights**

# SUPER LOW PROFILE - SPLIT COLOUR

Half & Half Colour Splits

SURFACE MOUNT LED DIRECTIONALS  
DIRECTIONNELS DEL À MONTAGE EN SURFACE



| Part No.       | Colour        | SAE                       |
|----------------|---------------|---------------------------|
| <b>E-916AA</b> | Amber   Amber | J595 Class 1 on 5 Flashes |
| <b>E-916AB</b> | Amber   Blue  | -                         |
| <b>E-916AW</b> | Amber   White | -                         |
| <b>E-916BB</b> | Blue   Blue   | J595 Class 1 on 3 Flashes |
| <b>E-916GG</b> | Green   Green | -                         |
| <b>E-916RR</b> | Red   Red     | J595 Class 1 on 5 Flashes |

|                |                             |
|----------------|-----------------------------|
| Mounting       | Surface Mount               |
| Lens Colour    | Clear                       |
| LED            | 6 x 1W                      |
| Flash Patterns | 23 Patterns                 |
| Voltage        | 12V - 24V                   |
| Amp Draw       | 0.6 @ 12V                   |
| Housing        | Aluminum                    |
| Lens           | Polycarbonate               |
| IP Rating      | IP67                        |
| EMC            | Certified                   |
| RoHS           | -                           |
| Dimensions     | 5.13" L x 1.25" W x 0.25" D |
| Connection     | 3x Lead Wires               |

## FEATURES & BENEFITS

- Mounting Options: 2 mounting holes @ 4.75" diameter / Stick-On

## ACCESSORIES

- F-S936** Fuse/Switch Kit
- E-F951** "L" Bracket
- E-F953** "T" Bracket
- E-F954** Adjustable Swivel Bracket



| Part No.       | Colour        | SAE                     |
|----------------|---------------|-------------------------|
| <b>E-906AA</b> | Amber   Amber | J595 Class 1 on 1 Flash |
| <b>E-906AW</b> | Amber   White | J595 Class 1 on 1 Flash |

|                |                             |
|----------------|-----------------------------|
| Mounting       | Surface Mount               |
| Lens Colour    | Clear                       |
| LED            | 6 x 3W                      |
| Flash Patterns | 23 Patterns                 |
| Voltage        | 12V - 24V                   |
| Amp Draw       | 0.7 @ 12V                   |
| Housing        | Aluminum                    |
| Lens           | Polycarbonate               |
| IP Rating      | IP65                        |
| EMC            | -                           |
| RoHS           | -                           |
| Dimensions     | 5.13" L x 1.25" W x 0.33" D |
| Connection     | 3x Lead Wires               |

## FEATURES & BENEFITS

- Mounting Options: 2 mounting holes @ 4.75" diameter / Stick-On

## ACCESSORIES

- F-S936** Fuse/Switch Kit
- E-F951** "L" Bracket
- E-F953** "T" Bracket
- E-F954** Adjustable Swivel Bracket

# SUPER LOW PROFILE

SAE Class 1



| Part No.      | Colour | SAE                       |
|---------------|--------|---------------------------|
| <b>E-912A</b> | Amber  | J595 Class 1 on 6 Flashes |

### FEATURES & BENEFITS

- Mounting Options: 2 mounting holes @ 3" diameter / Stick-On

### ACCESSORIES

- F-S936** Fuse/Switch Kit

|                |                            |
|----------------|----------------------------|
| Mounting       | Surface Mount              |
| Lens Colour    | Clear                      |
| LED            | 3 x 1W                     |
| Flash Patterns | 12 Patterns                |
| Voltage        | 12V - 24V                  |
| Amp Draw       | 0.6 @ 12V                  |
| Housing        | Aluminum                   |
| Lens           | Polycarbonate              |
| IP Rating      | IP68                       |
| EMC            | Certified                  |
| RoHS           | -                          |
| Dimensions     | 3.5" L x 1.25" W x 0.25" D |
| Connection     | 3x Lead Wires              |



| Part No.      | Colour | SAE                     |
|---------------|--------|-------------------------|
| <b>E-902A</b> | Amber  | J595 Class 1 on 1 Flash |

### FEATURES & BENEFITS

- Mounting Options: 2 mounting holes @ 3" diameter / Stick-On

### ACCESSORIES

- F-S936** Fuse/Switch Kit

|                |                            |
|----------------|----------------------------|
| Mounting       | Surface Mount              |
| Lens Colour    | Clear                      |
| LED            | 3 x 3W                     |
| Flash Patterns | 12 Patterns                |
| Voltage        | 12V - 24V                  |
| Amp Draw       | 0.6 @ 12V                  |
| Housing        | Aluminum                   |
| Lens           | Polycarbonate              |
| IP Rating      | IP65                       |
| EMC            | -                          |
| RoHS           | -                          |
| Dimensions     | 3.5" L x 1.25" W x 0.25" D |
| Connection     | 3x Lead Wires              |



# LOW PROFILE - SPLIT COLOUR

Half & Half Colour Splits

SURFACE MOUNT LED DIRECTIONALS  
DIRECTIONNELS DEL À MONTAGE EN SURFACE



| Part No.       | Colour        | SAE                       |
|----------------|---------------|---------------------------|
| <b>E-915AA</b> | Amber   Amber | J595 Class 1 on 5 Flashes |
| <b>E-915AW</b> | Amber   White | -                         |
| <b>E-915BB</b> | Blue   Blue   | J595 Class 1 on 5 Flashes |
| <b>E-915BR</b> | Blue   Red    | -                         |
| <b>E-915GG</b> | Green   Green | -                         |
| <b>E-915WW</b> | White   White | J595 Class 1 on 5 Flashes |

|                |                       |
|----------------|-----------------------|
| Mounting       | Surface Mount         |
| Lens Colour    | Clear                 |
| LED            | 6 x 1W                |
| Flash Patterns | 19 Patterns           |
| Voltage        | 12V - 24V             |
| Amp Draw       | 0.8 @ 12V             |
| Housing        | Aluminum              |
| Lens           | Polycarbonate         |
| IP Rating      | IP67                  |
| EMC            | Certified             |
| RoHS           | -                     |
| Dimensions     | 5" L x 1" W x 0.69" D |
| Connection     | 3x Lead Wires         |

## FEATURES & BENEFITS

- Mounting Options: 2 mounting holes @ 4.75" diameter

## ACCESSORIES

- F-S936** Fuse/Switch Kit
- E-F951** "L" Bracket
- E-F953** "T" Bracket
- E-F954** Adjustable Swivel Bracket



| Part No.       | Colour        | SAE                       |
|----------------|---------------|---------------------------|
| <b>E-917AA</b> | Amber   Amber | J845 Class 1 on 5 Flashes |

|                |                             |
|----------------|-----------------------------|
| Mounting       | Surface Mount               |
| Lens Colour    | Clear                       |
| LED            | 6 x 1.5W                    |
| Flash Patterns | 14 Patterns                 |
| Voltage        | 12V - 36V                   |
| Amp Draw       | 0.7 @ 12V                   |
| Housing        | Aluminum                    |
| Lens           | Polycarbonate               |
| IP Rating      | IP65                        |
| EMC            | -                           |
| RoHS           | -                           |
| Dimensions     | 5.13" L x 1.25" W x 0.33" D |
| Connection     | 3x Lead Wires               |

## FEATURES & BENEFITS

- Mounting Options: 2 mounting holes @ 4.75" diameter / Stick-On

## ACCESSORIES

- F-S936** Fuse/Switch Kit
- E-F951** "L" Bracket
- E-F953** "T" Bracket
- E-F954** Adjustable Swivel Bracket

# LOW PROFILE

SAE Class 1 / SAE Class 2



| Part No.      | Colour | SAE                       |
|---------------|--------|---------------------------|
| <b>E-913A</b> | Amber  | J595 Class 2 on 7 Flashes |
| <b>E-913R</b> | Red    | J595 Class 1 on 7 Flashes |
| <b>E-913W</b> | White  | J595 Class 2 on 7 Flashes |

### FEATURES & BENEFITS

- Mounting Options: 2 mounting holes @ 3" diameter

### ACCESSORIES

- F-5936** Fuse/Switch Kit

|                |                          |
|----------------|--------------------------|
| Mounting       | Surface Mount            |
| Lens Colour    | Clear                    |
| LED            | 3 x 1W                   |
| Flash Patterns | 12 Patterns              |
| Voltage        | 12V - 24V                |
| Amp Draw       | 0.2 @ 12V                |
| Housing        | Aluminum                 |
| Lens           | Polycarbonate            |
| IP Rating      | IP67                     |
| EMC            | Certified                |
| RoHS           | -                        |
| Dimensions     | 3.38" L x 1" W x 0.69" D |
| Connection     | 3x Lead Wires            |



**E-921A**



**E-921A-K**

**E-921A-KM**

| Part No.         | Mounting                       |
|------------------|--------------------------------|
| <b>E-921A</b>    | -                              |
| <b>E-921A-K</b>  | Open Grommet                   |
| <b>E-921A-KM</b> | Open Grommet & Steel L-Bracket |

### FEATURES & BENEFITS

- Visible Directional Arrow Design
- Fits into any existing 6" Oval Stop/Turn/Tail Housing

### ACCESSORIES

- F-5950** Fuse/Switch Kit

|                |                         |
|----------------|-------------------------|
| LED Colour     | Amber                   |
| Lens Colour    | Amber                   |
| LED            | 35 x 0.2W               |
| Flash Patterns | Sequential Arrow        |
| Voltage        | 9V - 36V                |
| Amp Draw       | 0.4 @ 12V               |
| Housing        | -                       |
| Lens           | Polycarbonate           |
| IP Rating      | IP67                    |
| EMC            | -                       |
| RoHS           | -                       |
| Dimensions     | 6.5" L x 2.25" W x 2" D |
| Connection     | 3-Prong Pigtail         |

# MEDIUM PROFILE

SAE Class 2

STROBE LIGHTS  
LAMPES STROBOSCOPIQUES

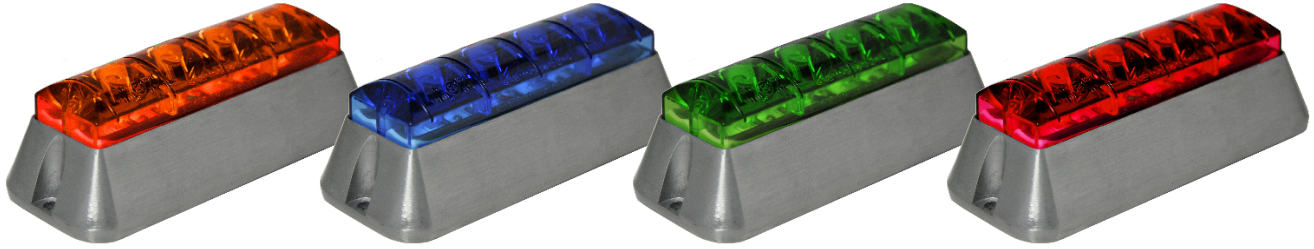

| Part No.      | Colour | SAE          |
|---------------|--------|--------------|
| <b>E-950A</b> | Amber  | J595 Class 2 |
| <b>E-950B</b> | Blue   | -            |
| <b>E-950G</b> | Green  | -            |
| <b>E-950R</b> | Red    | J595 Class 2 |

#### FEATURES & BENEFITS

- Mounting Options: 2 mounting holes @ 4.5" diameter

#### ACCESSORIES

- F-S950** Fuse/Switch Kit

|                |                             |
|----------------|-----------------------------|
| Mounting       | Surface Mount               |
| Lens Colour    | Same As Colour              |
| LED            | 4 x 1.5W                    |
| Flash Patterns | Quad Flash                  |
| Voltage        | 9V - 36V                    |
| Amp Draw       | 0.4 @ 12V                   |
| Housing        | Aluminum                    |
| Lens           | Polycarbonate               |
| IP Rating      | IP67                        |
| EMC            | Certified                   |
| RoHS           | -                           |
| Dimensions     | 4.75" L x 1.88" W x 1.63" D |
| Connection     | 3x Lead Wires               |



| Part No.       | Colour | SAE          |
|----------------|--------|--------------|
| <b>E-950CA</b> | Amber  | J595 Class 2 |
| <b>E-950CG</b> | Green  | -            |
| <b>E-950CW</b> | White  | J595 Class 2 |

#### FEATURES & BENEFITS

- Mounting Options: 2 mounting holes @ 4.5" diameter

#### ACCESSORIES

- F-S950** Fuse/Switch Kit

|                |                             |
|----------------|-----------------------------|
| Mounting       | Surface Mount               |
| Lens Colour    | Clear                       |
| LED            | 4 x 1.5W                    |
| Flash Patterns | Quad Flash                  |
| Voltage        | 9V - 36V                    |
| Amp Draw       | 0.4 @ 12V                   |
| Housing        | Aluminum                    |
| Lens           | Polycarbonate               |
| IP Rating      | IP67                        |
| EMC            | Certified                   |
| RoHS           | -                           |
| Dimensions     | 4.75" L x 1.88" W x 1.63" D |
| Connection     | 3x Lead Wires               |

# 6" OVAL

SAE Class 2

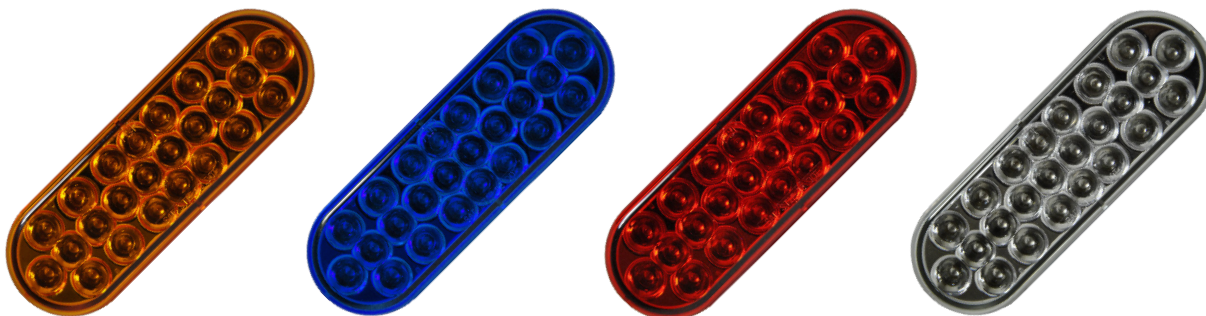

| Part No.               | Colour | SAE                         |
|------------------------|--------|-----------------------------|
| <b>E-920A</b>          | Amber  | J595 Class 2 & J845 Class 2 |
| <b>E-920B</b>          | Blue   | -                           |
| <b>E-920R</b>          | Red    | J595 Class 2 & J845 Class 2 |
| <b>CLEAR LENS LAMP</b> |        |                             |
| <b>E-920CA</b>         | Amber  | -                           |

**ACCESSORIES**

- F-S950** Fuse/Switch Kit
- Grommets** GR2238, GR2239
- Pigtails** PT9530, PT9532, PT9180, PT9182
- Mounting Brackets** MB2238
- Decorative Bezels** BZ2238, BZ2238V

|                |                            |
|----------------|----------------------------|
| LED            | 24 Diodes                  |
| Flash Patterns | Quad Flash                 |
| Voltage        | 9V - 36V                   |
| Amp Draw       | 0.4 @ 12V                  |
| Housing        | Polycarbonate Base         |
| Lens           | Polycarbonate              |
| IP Rating      | IP67                       |
| EMC            | Certified                  |
| RoHS           | -                          |
| Dimensions     | 6.5" L x 2.25" W x 1.75" D |
| Connection     | 3-Prong Pigtail            |

| AMBER KITS              |  |
|-------------------------|--|
| <b>E-920A-K</b>         | Amber • Open Grommet • Double Contact Pigtail                          |
| <b>E-920A-KM</b>        | Amber • Open Grommet • Double Contact Pigtail • Steel Mounting Bracket |
| BLUE KITS               |  |
| <b>E-920B-K</b>         | Blue • Open Grommet • Double Contact Pigtail                           |
| <b>E-920B-KM</b>        | Blue • Open Grommet • Double Contact Pigtail • Steel Mounting Bracket  |
| RED KITS                |  |
| <b>E-920R-K</b>         | Red • Open Grommet • Double Contact Pigtail                            |
| <b>E-920R-KM</b>        | Red • Open Grommet • Double Contact Pigtail • Steel Mounting Bracket   |
| AMBER KITS - CLEAR LENS |  |
| <b>E-920CA-K</b>        | Amber • Open Grommet • Double Contact Pigtail                          |
| <b>E-920CA-KM</b>       | Amber • Open Grommet • Double Contact Pigtail • Steel Mounting Bracket |



# 4" ROUND

SAE Class 2

STROBE LIGHTS  
LAMPES STROBOSCOPIQUES

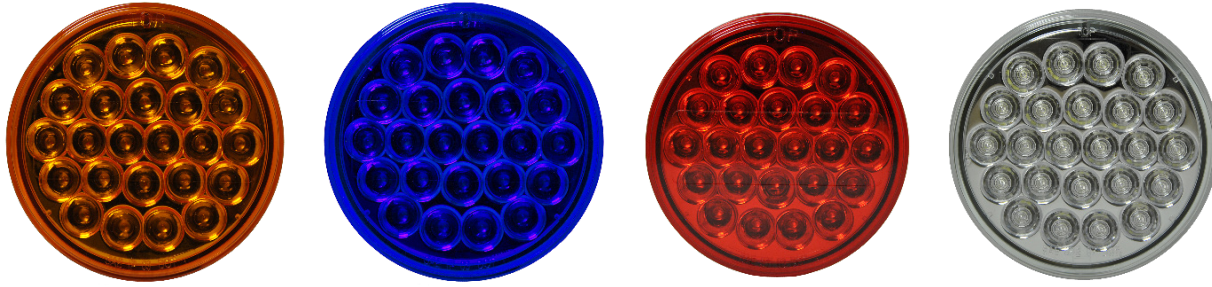

| Part No.               | Colour | SAE                         |
|------------------------|--------|-----------------------------|
| <b>E-940A</b>          | Amber  | J595 Class 2 & J845 Class 2 |
| <b>E-940B</b>          | Blue   | -                           |
| <b>E-940R</b>          | Red    | J595 Class 2 & J845 Class 2 |
| <b>CLEAR LENS LAMP</b> |        |                             |
| <b>E-940CA</b>         | Amber  | -                           |

|                |                            |
|----------------|----------------------------|
| LED            | 24 Diodes                  |
| Flash Patterns | Quad Flash                 |
| Voltage        | 9V - 36V                   |
| Amp Draw       | 0.4 @ 12V                  |
| Housing        | Polycarbonate Base         |
| Lens           | Polycarbonate              |
| IP Rating      | IP67                       |
| EMC            | Certified                  |
| RoHS           | -                          |
| Dimensions     | 6.5" L x 2.25" W x 1.75" D |
| Connection     | 3-Prong Pigtail            |

#### ACCESSORIES

|                          |                                |
|--------------------------|--------------------------------|
| <b>F-S950</b>            | Fuse/Switch Kit                |
| <b>Grommets</b>          | GR4000, GR4001                 |
| <b>Pigtails</b>          | PT9530, PT9532, PT9180, PT9182 |
| <b>Mounting Brackets</b> | MB4000                         |
| <b>Decorative Bezels</b> | BZ4000, BZ4000V                |

| AMBER KITS       |  |
|------------------|--|
| <b>E-940A-K</b>  | Amber • Open Grommet • Double Contact Pigtail                          |
| <b>E-940A-KM</b> | Amber • Open Grommet • Double Contact Pigtail • Steel Mounting Bracket |
| <b>EH-940A</b>   | Amber • Rubber Assembly • Double Contact Pigtail                       |
| <b>EHM-940A</b>  | Amber • Rubber Assembly • Cigarette Adaptor • Magnetic Base            |

| BLUE KITS        |   |
|------------------|---|
| <b>E-940B-K</b>  | Blue • Open Grommet • Double Contact Pigtail                          |
| <b>E-940B-KM</b> | Blue • Open Grommet • Double Contact Pigtail • Steel Mounting Bracket |
| <b>EH-940B</b>   | Blue • Rubber Assembly • Double Contact Pigtail                       |
| <b>EHM-940B</b>  | Blue • Rubber Assembly • Cigarette Adaptor • Magnetic Base            |

| RED KITS         |  |
|------------------|--|
| <b>E-940R-K</b>  | Red • Open Grommet • Double Contact Pigtail                          |
| <b>E-940R-KM</b> | Red • Open Grommet • Double Contact Pigtail • Steel Mounting Bracket |
| <b>EH-940R</b>   | Red • Rubber Assembly • Double Contact Pigtail                       |
| <b>EHM-940R</b>  | Red • Rubber Assembly • Cigarette Adaptor • Magnetic Base            |

| AMBER KITS - CLEAR LENS |  |
|-------------------------|--|
| <b>E-940CA-K</b>        | Amber • Open Grommet • Double Contact Pigtail                          |
| <b>E-940CA-KM</b>       | Amber • Open Grommet • Double Contact Pigtail • Steel Mounting Bracket |
| <b>EH-940CA</b>         | Amber • Rubber Assembly • Double Contact Pigtail                       |
| <b>EHM-940CA</b>        | Amber • Rubber Assembly • Cigarette Adaptor • Magnetic Base            |





# 6.5" BATTERY OPERATED



| Part No.            | Colour | Mounting           | SAE |
|---------------------|--------|--------------------|-----|
| <b>LEDM4065-18A</b> | Amber  | Regular Magnets    | T   |
| <b>LEDM4066-18A</b> | Amber  | Standard Magnets   | -   |
| <b>LEDM4165-18A</b> | Amber  | Heavy Duty Magnets | T   |
| <b>LEDH4065-18A</b> | Amber  | Surface Mount      | T   |
| <b>LEDM4065-18G</b> | Green  | Regular Magnets    | -   |
| <b>LEDM4065-18R</b> | Red    | Regular Magnets    | T   |
| <b>LEDM4066-18R</b> | Red    | Standard Magnets   | -   |
| <b>LEDM4165-18R</b> | Red    | Heavy Duty Magnets | T   |
| <b>LEDH4065-18R</b> | Red    | Surface Mount      | T   |
| <b>LEDM4065-18W</b> | White  | Regular Magnets    | -   |

|                |                          |
|----------------|--------------------------|
| LED            | 18 Diodes                |
| Flash Patterns | Single Flash / Steady ON |
| Battery Type   | 4x AA (not included)     |
| Housing        | ABS Base                 |
| Lens           | Acrylic                  |
| IP Rating      | -                        |
| EMC            | -                        |
| RoHS           | -                        |
| Dimensions     | 6.38" L x 4" W x 2.25" D |

#### FEATURES & BENEFITS

- Built-In ON-OFF Switch
- Universal strobe light application. Can be used for any situation.

For Retail Bag, add the suffix 'P' to the end of the Part No.

**Regular Magnets**



**Standard Magnets**



**Heavy Duty Magnets**



**Surface Mount**





# MINI LED STROBE HEADS

Surface Mount / Internal Head & Tail Lamp Assembly

STROBE LIGHTS  
LAMPES STROBOSCOPIQUES

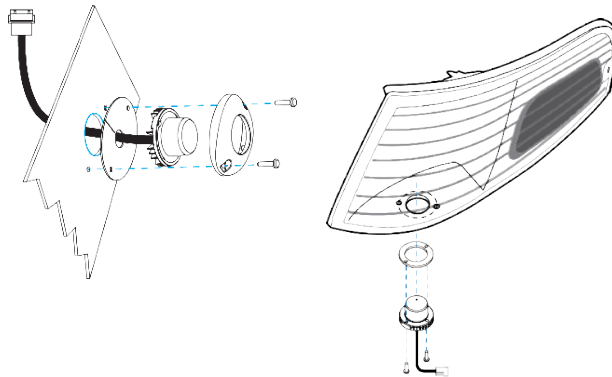

| Part No.        | Colour | Connection    |
|-----------------|--------|---------------|
| <b>E-986CAK</b> | Amber  | 3x Lead Wires |

### FEATURES & BENEFITS

- Can be installed into head/tail lamp assemblies
- Waterproof Connectors
- Gasket & Screws included
- Black Flanges included
- Mounting Options: 2 mounting holes @ 1.28" centre

### ACCESSORIES

- F-S955** Fuse/Switch Kit
- E-F985-5** Chrome Flange

|                |                                      |
|----------------|--------------------------------------|
| Mounting       | Surface Mount / Lamp Assembly Insert |
| Lens Colour    | Clear                                |
| LED            | 6 Diodes                             |
| Flash Patterns | 19 Patterns                          |
| Voltage        | 12V                                  |
| Amp Draw       | 0.7 @ 12V                            |
| Housing        | Aluminum Base                        |
| Lens           | Polycarbonate                        |
| IP Rating      | -                                    |
| EMC            | -                                    |
| RoHS           | -                                    |
| Dimensions     | 1.5" Dia. x 1.06" H                  |
| Connection     | 3x Lead Wires                        |

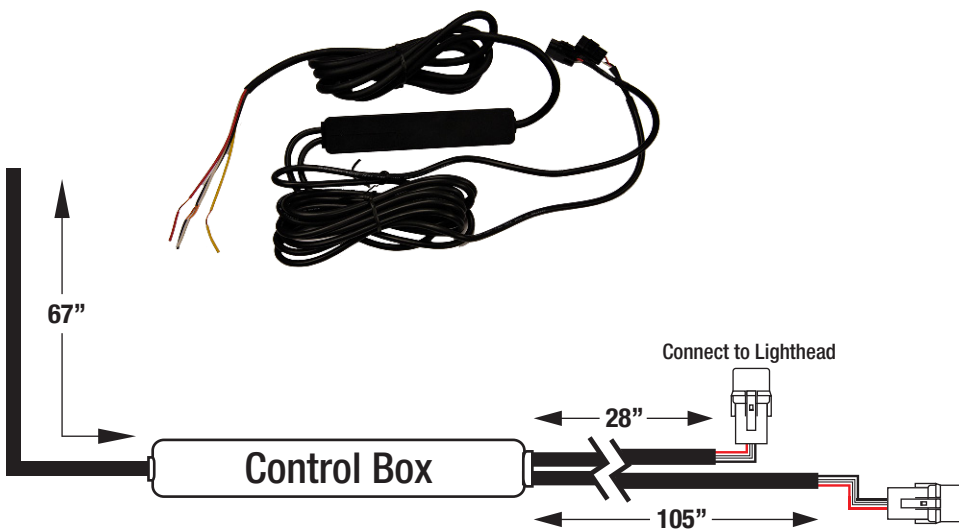

# EW20 SERIES

Fully Lit - Super Glow

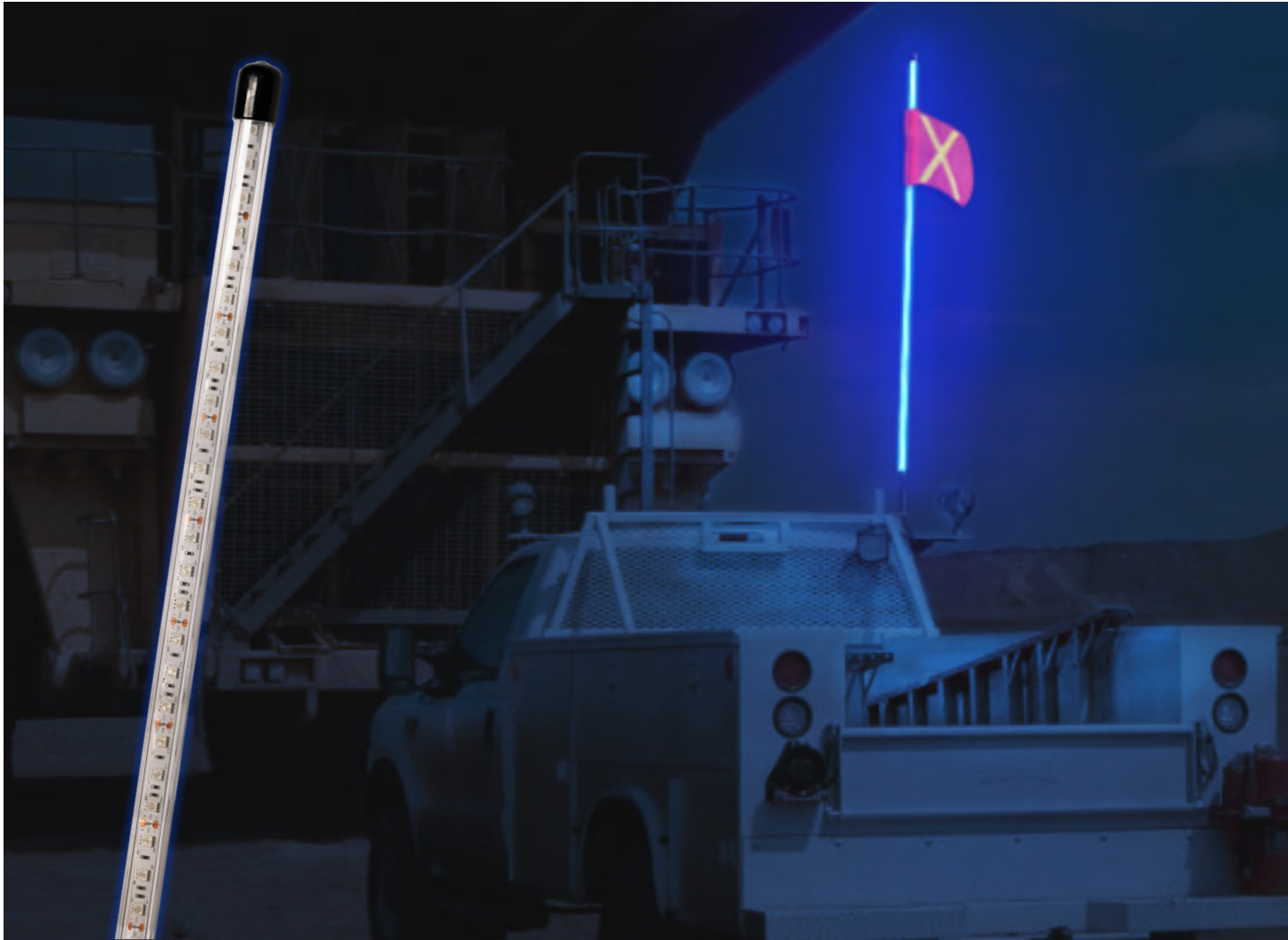

| Length | Part No.       | Colour |
|--------|----------------|--------|
| 4 FT   | <b>EW2040A</b> | Amber  |
|        | <b>EW2040B</b> | Blue   |
|        | <b>EW2040G</b> | Green  |
|        | <b>EW2040R</b> | Red    |
|        | <b>EW2040W</b> | White  |
| 5 FT   | <b>EW2050A</b> | Amber  |
|        | <b>EW2050B</b> | Blue   |
|        | <b>EW2050G</b> | Green  |
|        | <b>EW2050R</b> | Red    |
|        | <b>EW2050W</b> | White  |
| 6 FT   | <b>EW2060A</b> | Amber  |
|        | <b>EW2060B</b> | Blue   |
|        | <b>EW2060G</b> | Green  |
|        | <b>EW2060R</b> | Red    |
|        | <b>EW2060W</b> | White  |

|            |                        |
|------------|------------------------|
| Mounting   | Quick Disconnect Mount |
| Type       | Steady ON              |
| Voltage    | 12V                    |
| Amp Draw   | 3.5 @ 12V              |
| Housing    | Aluminum Base          |
| Lens       | Flexi Fiberglass Tube  |
| Connection | 2x Lead Wires          |

#### FEATURES & BENEFITS

- Working Temperature: down to -40°C

#### ACCESSORIES

- EWR610** 12" Reflective Flag with Amber X
- EWR616** 16" Reflective Flag with Amber X
- EWR620** Black Electroplated Stainless Steel Spring Mount
- EWR710** Right Angle Bracket
- EWR720** Mount with Lay Down Bracket
- EWR730** Retainer Hook

# EW30 SERIES

Fully Lit - Uniform Glow

LED SAFETY WHIPS  
FOUET DE SÉCURITÉ À DEL

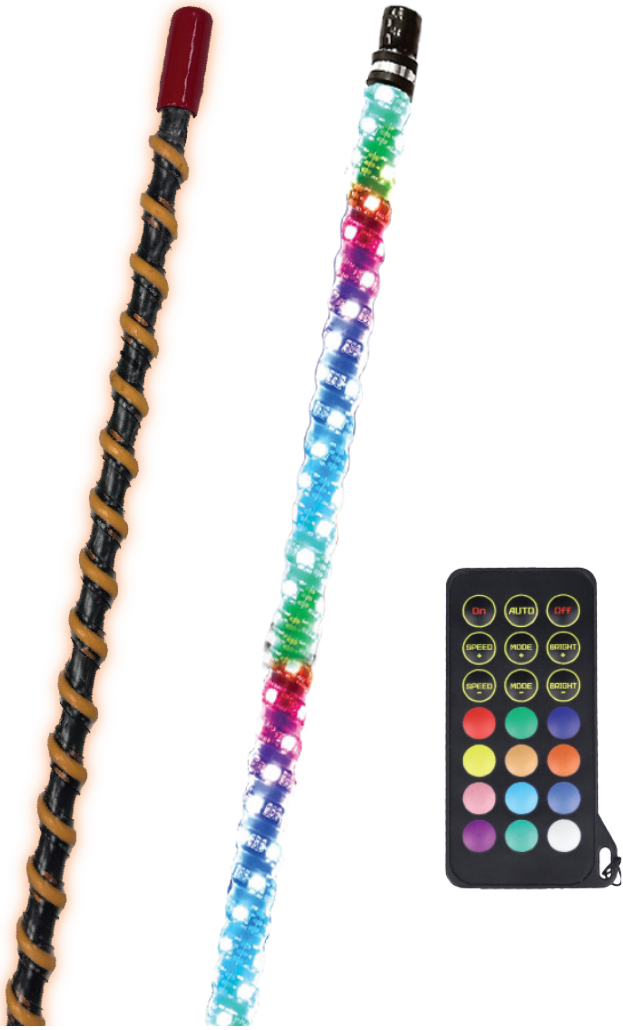

| Length | Part No.            | Colour |
|--------|---------------------|--------|
| 4 FT   | <b>EW3040RGB</b>    | RGB    |
|        | <b>EW3040RGB-2K</b> | RGB    |

\*EW3040RGB-2K is synchronizeable

| Length | Part No.       | Colour |
|--------|----------------|--------|
| 5 FT   | <b>EW3050A</b> | Amber  |
| 6 FT   | <b>EW3060A</b> | Amber  |

|            |                        |
|------------|------------------------|
| Mounting   | Quick Disconnect Mount |
| Type       | Steady ON              |
| Voltage    | 12V                    |
| Amp Draw   | 3.0 @ 12V              |
| Housing    | Aluminum Base          |
| Lens       | Flexi Fiberglass Tube  |
| Connection | 2x Lead Wires          |

**FEATURES & BENEFITS**

- Working Temperature: down to -40°C
- New Design for Improved Durability

**ACCESSORIES**

- EWR610** 12" Reflective Flag with Amber X
- EWR616** 16" Reflective Flag with Amber X
- EWR620** Black Electroplated Stainless Steel Spring Mount
- EWR710** Right Angle Bracket
- EWR720** Mount with Lay Down Bracket
- EWR730** Retainer Hook

# EW60 SERIES

Top Lit - Steady Light

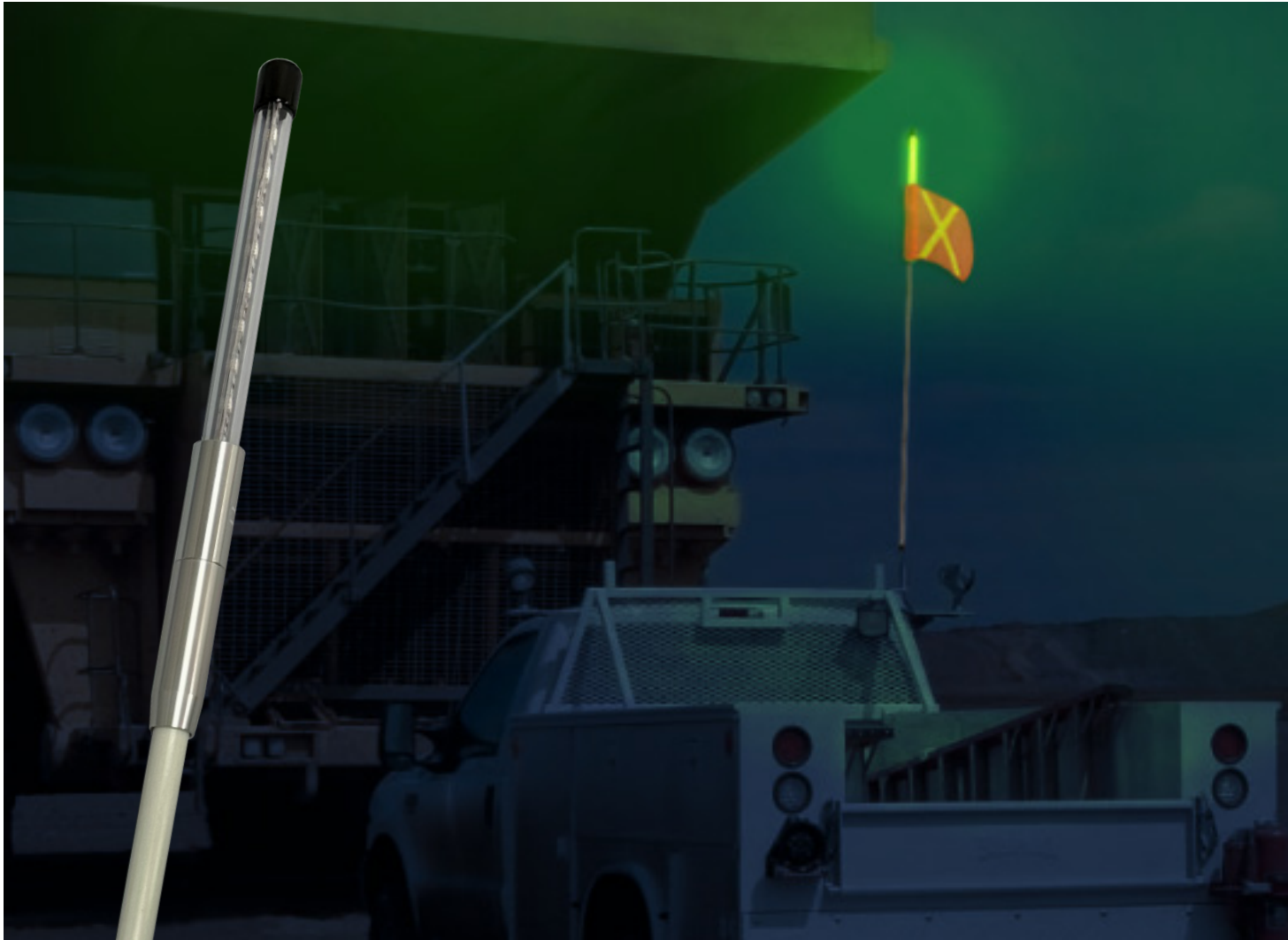

| Length | Part No.        | Colour      |
|--------|-----------------|-------------|
| 3 FT   | <b>EW6030AR</b> | Amber & Red |
|        | <b>EW6060A</b>  | Amber       |
| 6 FT   | <b>EW6060G</b>  | Green       |
|        | <b>EW6060R</b>  | Red         |
|        | <b>EW6060W</b>  | White       |
|        | <b>EW6080A</b>  | Amber       |
| 8 FT   | <b>EW6080G</b>  | Green       |
|        | <b>EW6080R</b>  | Red         |
|        | <b>EW6080W</b>  | White       |
|        | <b>EW6100A</b>  | Amber       |
| 10 FT  | <b>EW6100G</b>  | Green       |
|        | <b>EW6100R</b>  | Red         |
|        | <b>EW6100W</b>  | White       |

|            |                        |
|------------|------------------------|
| Mounting   | Quick Disconnect Mount |
| Type       | Steady ON              |
| Voltage    | 12V                    |
| Amp Draw   | 3.5 @ 12V              |
| Housing    | Aluminum Base          |
| Lens       | Flexi Fiberglass Tube  |
| Connection | 2x Lead Wires          |

#### FEATURES & BENEFITS

- Working Temperature: down to  $-40^{\circ}\text{C}$
- 12" Reflective Flag (included)

#### ACCESSORIES

- EWR610** 12" Reflective Flag with Amber X
- EWR616** 16" Reflective Flag with Amber X
- EWR620** Black Electroplated Stainless Steel Spring Mount
- EWR710** Right Angle Bracket
- EWR720** Mount with Lay Down Bracket
- EWR730** Retainer Hook
- EWL600A** Screw On Top Light ONLY - Steady Amber
- EWL600G** Screw On Top Light ONLY - Steady Green
- EWL600R** Screw On Top Light ONLY - Steady Red
- EWL600W** Screw On Top Light ONLY - Steady White



# EW60 SERIES

Top Lit - Flashing Light

LED SAFETY WHIPS  
FOUET DE SÉCURITÉ À DEL



| Length | Part No.       | Colour |
|--------|----------------|--------|
| 6 FT   | <b>EW6061A</b> | Amber  |
|        | <b>EW6061G</b> | Green  |
|        | <b>EW6061R</b> | Red    |
|        | <b>EW6061W</b> | White  |
| 8 FT   | <b>EW6081A</b> | Amber  |
|        | <b>EW6081G</b> | Green  |
|        | <b>EW6081R</b> | Red    |
|        | <b>EW6081W</b> | White  |
| 10 FT  | <b>EW6101A</b> | Amber  |
|        | <b>EW6101G</b> | Green  |
|        | <b>EW6101R</b> | Red    |
|        | <b>EW6101W</b> | White  |
| 12 FT  | <b>EW6120A</b> | Amber  |
| 14 FT  | <b>EW6140A</b> | Amber  |

|            |                        |
|------------|------------------------|
| Mounting   | Quick Disconnect Mount |
| Type       | Single Flash           |
| Voltage    | 12V                    |
| Amp Draw   | 3.5 @ 12V              |
| Housing    | Aluminum Base          |
| Lens       | Flexi Fiberglass Tube  |
| Connection | 2x Lead Wires          |

#### FEATURES & BENEFITS

- Working Temperature: down to -40°C
- 12" Reflective Flag (included)

#### ACCESSORIES

- EWR610** 12" Reflective Flag with Amber X
- EWR616** 16" Reflective Flag with Amber X
- EWR620** Black Electroplated Stainless Steel Spring Mount
- EWR710** Right Angle Bracket
- EWR720** Mount with Lay Down Bracket
- EWR730** Retainer Hook
- EWL601A** Screw On Top Light ONLY - Flashing Amber
- EWL601G** Screw On Top Light ONLY - Flashing Green
- EWL601R** Screw On Top Light ONLY - Flashing Red
- EWL601W** Screw On Top Light ONLY - Flashing White

# INTERIOR LAMPS



| Part No.         | Colour |
|------------------|--------|
| <b>LDR3030-C</b> | White  |

### FEATURES & BENEFITS

- **Touch Sensor Capability. Tap to Turn ON-Dim-OFF.**
- **USB Charging Cable included**
- **Run Time up to 3 Hours**
- **Battery Charging Time: 3 Hours**

|              |                          |
|--------------|--------------------------|
| Mounting     | Slide On Bracket Mount   |
| Lumens       | -                        |
| Lens Colour  | Clear                    |
| LED          | 8 Diodes                 |
| Battery Type | Built-In Rechargeable    |
| Housing      | Polycarbonate            |
| Lens         | Polycarbonate            |
| IP Rating    | -                        |
| EMC          | -                        |
| RoHS         | -                        |
| Dimensions   | 3.13" L x 3.13" W x 1" H |



**12V**

| Part No.        | Colour     | Connection    |
|-----------------|------------|---------------|
| <b>LDL6034C</b> | Cool White | 2x Lead Wires |

For Retail Bag, Add the nomenclature 'P' to the end of the Part No.

### FEATURES & BENEFITS

- **Low Profile Design**

|             |                             |
|-------------|-----------------------------|
| Mounting    | Surface Mount               |
| Lumens      | 185                         |
| Lens Colour | Clear                       |
| LED         | 15 Diodes                   |
| Amp Draw    | 0.41 @ 12V                  |
| Housing     | ABS Base                    |
| Lens        | Polycarbonate               |
| IP Rating   | -                           |
| EMC         | Certified                   |
| RoHS        | -                           |
| Dimensions  | 5.75" L x 2.75" W x 0.75" H |



**12V**

| Part No.        | Colour     | Connection    |
|-----------------|------------|---------------|
| <b>LDL6030C</b> | Cool White | 2x Lead Wires |

For Retail Bag, Add the nomenclature 'P' to the end of the Part No.

### FEATURES & BENEFITS

- **Low Profile Design**

|             |                             |
|-------------|-----------------------------|
| Mounting    | Surface Mount               |
| Lumens      | 400                         |
| Lens Colour | Clear                       |
| LED         | 12 Diodes                   |
| Amp Draw    | 0.4 @ 12V                   |
| Housing     | Polycarbonate               |
| Lens        | Polycarbonate               |
| IP Rating   | -                           |
| EMC         | -                           |
| RoHS        | -                           |
| Dimensions  | 5.75" L x 2.75" W x 0.75" H |





12V

| Part No.        | Colour     | Connection    |
|-----------------|------------|---------------|
| <b>LDL6061C</b> | Warm White | 2x Lead Wires |

For Retail Bag, Add the nomenclature 'P' to the end of the Part No.

#### FEATURES & BENEFITS

- **Low Profile Design**

|             |                          |
|-------------|--------------------------|
| Mounting    | Surface Mount            |
| Lumens      | 360                      |
| Lens Colour | White                    |
| LED         | 9 Diodes                 |
| Amp Draw    | 0.3 @ 12V                |
| Housing     | ABS Base                 |
| Lens        | Polycarbonate            |
| IP Rating   | -                        |
| EMC         | Certified                |
| RoHS        | -                        |
| Dimensions  | 6.38" L x 6" W x 0.63" H |



12V

| Part No.        | Colour | Connection    |
|-----------------|--------|---------------|
| <b>LDL7550C</b> | White  | 2x Lead Wires |

For Retail Bag, Add the nomenclature 'P' to the end of the Part No.

#### FEATURES & BENEFITS

- **Bigger & More Robust Size**
- **Diamond Shaped Lens for a more Uniform Beam Spread**

|             |                       |
|-------------|-----------------------|
| Mounting    | Surface Mount         |
| Lumens      | 250                   |
| Lens Colour | Clear                 |
| LED         | 60 Diodes             |
| Amp Draw    | 0.57 @ 12V            |
| Housing     | ABS Base              |
| Lens        | Polycarbonate         |
| IP Rating   | -                     |
| EMC         | -                     |
| RoHS        | -                     |
| Dimensions  | 7" L x 4" W x 1.38" H |



12V

| Part No.        | Colour | Connection    |
|-----------------|--------|---------------|
| <b>LDL8015C</b> | White  | 2x Lead Wires |

For Retail Bag, Add the nomenclature 'P' to the end of the Part No.

#### FEATURES & BENEFITS

- **Slim & Long, great for tight and narrow spaces**
- **Diamond Shaped Lens for a more Uniform Beam Spread**
- **Built-In ON-OFF Switch**

|             |                             |
|-------------|-----------------------------|
| Mounting    | Surface Mount               |
| Lumens      | 80                          |
| Lens Colour | Clear                       |
| LED         | 33 Diodes                   |
| Amp Draw    | 0.47 @ 12V                  |
| Housing     | Aluminum Base & ABS Body    |
| Lens        | Polycarbonate               |
| IP Rating   | -                           |
| EMC         | -                           |
| RoHS        | -                           |
| Dimensions  | 8.25" L x 1.63" W x 0.75" H |

# INTERIOR LAMPS

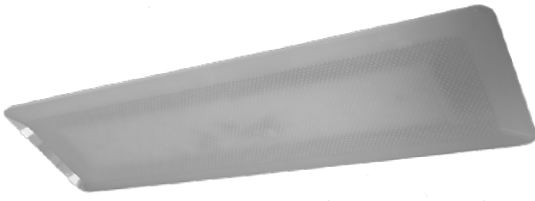

**12V to 24V**

| Part No.        | Colour     | Connection    |
|-----------------|------------|---------------|
| <b>LDL1140C</b> | Cool White | 2x Lead Wires |

For Retail Bag, Add the nomenclature 'P' to the end of the Part No.

**FEATURES & BENEFITS**

- Super Low Profile Design

|             |                          |
|-------------|--------------------------|
| Mounting    | Surface Mount            |
| Lumens      | 303                      |
| Lens Colour | White                    |
| LED         | 30 Diodes                |
| Amp Draw    | 0.4 @ 12V                |
| Housing     | Polycarbonate            |
| Lens        | Polycarbonate            |
| IP Rating   | -                        |
| EMC         | Certified                |
| RoHS        | -                        |
| Dimensions  | 11.5" L x 4" W x 0.75" H |

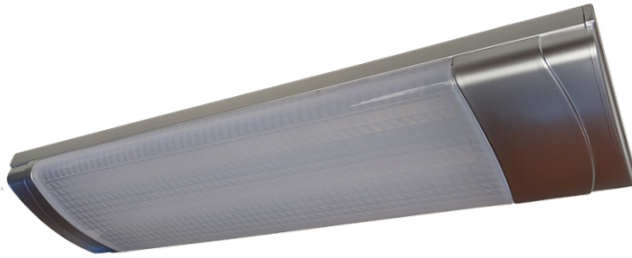

**12V to 24V**

| Part No.        | Colour     | Connection    |
|-----------------|------------|---------------|
| <b>LDL1540C</b> | Cool White | 2x Lead Wires |

**FEATURES & BENEFITS**

- Bigger & More Robust Size
- Built-In HI-LOW-OFF Switch

|             |                              |
|-------------|------------------------------|
| Mounting    | Surface Mount                |
| Lumens      | 317                          |
| Lens Colour | White                        |
| LED         | 30 Diodes                    |
| Amp Draw    | 0.55 @ 12V                   |
| Housing     | Aluminum Base & ABS Body     |
| Lens        | Polyethylene                 |
| IP Rating   | -                            |
| EMC         | Certified                    |
| RoHS        | -                            |
| Dimensions  | 15.63" L x 4.25" W x 1.25" H |



**12V**

| Part No.        | Colour | Connection    |
|-----------------|--------|---------------|
| <b>LDL6000C</b> | White  | 2x Lead Wires |

For Retail Bag, Add the nomenclature 'P' to the end of the Part No.

**FEATURES & BENEFITS**

- Low Profile Design
- Built-In ON-OFF Switch

|             |                      |
|-------------|----------------------|
| Mounting    | Surface Mount        |
| Lumens      | 120                  |
| Lens Colour | Clear                |
| LED         | 40 Diodes            |
| Amp Draw    | 0.51 @ 12V           |
| Housing     | ABS Base             |
| Lens        | Polycarbonate        |
| IP Rating   | -                    |
| EMC         | -                    |
| RoHS        | -                    |
| Dimensions  | 5.64" Dia. x 1.13" H |

# OUTDOOR LAMPS



12V

| Part No.        | Colour | Connection    |
|-----------------|--------|---------------|
| <b>LDL2040C</b> | White  | 2x Lead Wires |

For Retail Bag, Add the nomenclature 'P' to the end of the Part No.

**FEATURES & BENEFITS**

- Hermetically Designed Lens
- Replaceable Bulb

|             |                      |
|-------------|----------------------|
| Mounting    | Surface Mount        |
| Lens Colour | Clear                |
| Bulb Type   | (2x) #194            |
| Amp Draw    | 0.2 @ 12V            |
| Housing     | ABS Base             |
| Lens        | Polycarbonate        |
| IP Rating   | -                    |
| EMC         | -                    |
| RoHS        | -                    |
| Dimensions  | 4" L x 2" W x 1.5" H |



12V

| Part No.          | Colour | Connection    |
|-------------------|--------|---------------|
| <b>LED1115-4C</b> | White  | 2x Lead Wires |

For Retail Bag, Add the nomenclature 'P' to the end of the Part No.

**FEATURES & BENEFITS**

- Decorative ABS Chrome Bezel included
- Waterproof Design

|             |                            |
|-------------|----------------------------|
| Mounting    | Surface Mount              |
| Lumens      | 50                         |
| Lens Colour | Clear                      |
| LED         | 4 Diodes                   |
| Amp Draw    | 0.3 @ 12V                  |
| Housing     | Polycarbonate              |
| Lens        | Polycarbonate              |
| IP Rating   | -                          |
| EMC         | -                          |
| RoHS        | -                          |
| Dimensions  | 4.69" L x 1.5" W x 0.75" H |



10V to 30V

| Part No.           | Colour | Connection           |
|--------------------|--------|----------------------|
| <b>LDL6018M-12</b> | White  | 2x Bullet Connectors |

**FEATURES & BENEFITS**

- Motion Sensor up to 12ft

|             |                          |
|-------------|--------------------------|
| Mounting    | Surface Mount            |
| Lumens      | 2400                     |
| Lens Colour | Clear                    |
| LED         | 12 Diodes                |
| Amp Draw    | 1.1 @ 12V                |
| Housing     | Steel                    |
| Lens        | Polycarbonate            |
| IP Rating   | -                        |
| EMC         | -                        |
| RoHS        | -                        |
| Dimensions  | 18.5" L x 5.75" W x 1" H |

# OUTDOOR LAMPS



**9V to 36V**

| Part No.      | Colour | Connection    |
|---------------|--------|---------------|
| <b>LW5015</b> | White  | 2x Lead Wires |

**FEATURES & BENEFITS**

- **Electronic Thermal Management to control lamp temperature**
- **Sealed Deutsch Connectors (male mating connector included)**
- **Surface Mount @ 35° angle / Rubber Mount @ 48° angle**
- Pressure relief valve. Reverse voltage protection

|              |                             |
|--------------|-----------------------------|
| Mounting     | Surface Mount               |
| Beam Pattern | Wide Flood                  |
| Lumens       | 2800                        |
| Lens Colour  | Clear                       |
| LED          | 4 x 6W                      |
| Amp Draw     | 1.6 @ 12V                   |
| Housing      | Aluminum Body               |
| Lens         | Polycarbonate               |
| CISPR Rating | Class 3                     |
| IP Rating    | -                           |
| EMC          | Certified                   |
| RoHS         | Certified                   |
| Dimensions   | 5.13" L x 1.63" W x 0.75" H |



**12V**

| Part No.        | Colour     | Connection    |
|-----------------|------------|---------------|
| <b>LDL8030C</b> | Cool White | 2x Lead Wires |

For Retail Bag, add the suffix 'P' to the end of the Part No.

**FEATURES & BENEFITS**

- **Designed to be used as a Porch Lamp**

|             |                         |
|-------------|-------------------------|
| Mounting    | Surface Mount           |
| Lumens      | 240                     |
| Lens Colour | Clear                   |
| LED         | 6 Diodes                |
| Amp Draw    | 0.3 @ 12V               |
| Housing     | ABS Body                |
| Lens        | Polycarbonate           |
| IP Rating   | IP65                    |
| EMC         | Certified               |
| RoHS        | -                       |
| Dimensions  | 7.88" L x 3.5" W x 1" H |



**12V**

| Part No.        | Colour     | Connection    |
|-----------------|------------|---------------|
| <b>LDL6004C</b> | Cool White | 2x Lead Wires |

For Retail Bag, add the suffix 'P' to the end of the Part No.

**FEATURES & BENEFITS**

- **Low Profile Design**

|             |                      |
|-------------|----------------------|
| Mounting    | Surface Mount        |
| Lumens      | 160                  |
| Lens Colour | Clear                |
| LED         | 42 Diodes            |
| Amp Draw    | 0.54 @ 12V           |
| Housing     | ABS Base             |
| Lens        | Polycarbonate        |
| IP Rating   | IP66                 |
| EMC         | Certified            |
| RoHS        | -                    |
| Dimensions  | 5.88" Dia. x 0.75" H |

# TRADITIONAL LAMPS



Sealed Polycarbonate Lens  
Mounts in Maximum 0.81" hole  
Amp Draw: 0.04 @ 12V

| Part No.        | Colour | Function | Lens Type    | SAE | Voltage | Connection      |
|-----------------|--------|----------|--------------|-----|---------|-----------------|
| <b>LED0700G</b> | Green  | Utility  | Double Point | -   | 12V     | (2x) Lead Wires |
| <b>LED0720B</b> | Blue   | Utility  | Smooth Lens  | -   | 12V     | (2x) Lead Wires |
| <b>LED0720G</b> | Green  | Utility  | Smooth Lens  | -   | 12V     | (2x) Lead Wires |

### CLEAR LENS LAMPS

|                 |       |         |              |   |     |                 |
|-----------------|-------|---------|--------------|---|-----|-----------------|
| <b>LED0700C</b> | White | Utility | Double Point | - | 12V | (2x) Lead Wires |
| <b>LED0720C</b> | White | Utility | Smooth Lens  | - | 12V | (2x) Lead Wires |

For Retail Bag, add the suffix 'P' to the end of the Part No.

Grommets GR0700  
Decorative Bezels BZ0700

## Mini Hooded Utility Lamp

12V

Chrome Plated Steel Housing & Polycarbonate Lens w/ Hooded Visor  
Mounting: 2" centre



| Part No.       | Type         | Diodes/Bulb | Function     | Amp Draw |
|----------------|--------------|-------------|--------------|----------|
| <b>LLP2020</b> | LED          | 2 Diodes    | Utility/Dome | 0.1      |
| <b>DL2020</b>  | Incandescent | #193        | Utility/Dome | 0.27     |

For Retail Bag, add the suffix 'P' to the end of the Part No.



10V to 30V

| Part No.      | Colour | Connection    |
|---------------|--------|---------------|
| <b>LW2017</b> | White  | 2x Lead Wires |

### FEATURES & BENEFITS

- Designed for Compact Spaces
- Super Wide Beam for it's mini size
- Rubber Mounting Pad
- Reverse voltage protection

|                  |                            |
|------------------|----------------------------|
| Mounting         | Surface Mount              |
| Beam Pattern     | Wide Flood                 |
| Raw Lumens       | 945                        |
| Effective Lumens | 745                        |
| LED              | 6 x 1.5W                   |
| Amp Draw         | 0.6 @ 12V                  |
| Housing          | High UV Resistant Aluminum |
| Lens             | Polycarbonate              |
| IP Rating        | IP68                       |
| EMC              | Certified                  |
| RoHS             | Certified                  |
| Dimensions       | 2.83" L x 1.5" W x 0.5" D  |

# TRADITIONAL LAMPS



## 2" Rectangular Incandescent Lamp 12V

Sealed Polycarbonate Lens & Base

| Part No.       | Colour | Function     | SAE | Amp Draw |
|----------------|--------|--------------|-----|----------|
| <b>SE1225C</b> | White  | Utility/Dome | -   | 0.33     |

For Retail Bag, Add the nomenclature 'P' to the end of each Part No.

**Pigtails** PT6020 / PT6022  
**Replacement Housing**



| INCANDESCENT KITS |   |
|-------------------|---|
| <b>KT2132C</b>    | Incandescent • Black Base Mount w/ Built-In Ground        |
| <b>KT2133C</b>    | Incandescent • Gray Base Mount w/ Built-In Ground         |
| <b>KT2134C</b>    | Incandescent • Chrome Base Mount w/ Built-In Ground       |
| <b>KT2126C</b>    | Incandescent • Chrome Base Mount • Single Contact Pigtail |
| <b>KT2128C</b>    | Incandescent • Black Base Mount • Single Contact Pigtail  |
| <b>KT2129C</b>    | Incandescent • Gray Base Mount • Single Contact Pigtail   |
| <b>KT3127C</b>    | Incandescent • White Rail Mount • Single Contact Pigtail  |
| <b>KT2130C</b>    | Incandescent • Black Rail Mount • Single Contact Pigtail  |
| <b>KT2131C</b>    | Incandescent • Gray Rail Mount • Single Contact Pigtail   |



## 4" Bullseye Incandescent Lamp 12V

Sealed Polycarbonate Lens & Base

| Part No.       | Colour | Function     | SAE | Amp Draw |
|----------------|--------|--------------|-----|----------|
| <b>ML2040C</b> | White  | Utility/Dome | -   | 0.54     |

For Retail Bag, Add the nomenclature 'P' to the end of each Part No.

**Pigtails** PT6020 / PT6022  
**Replacement Lens** MLR2040C  
**Replacement Bulb** HB194

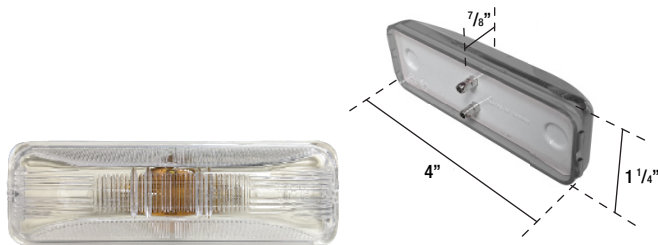
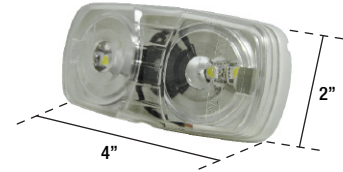

## 4" Rectangular Incandescent Lamp 12V

Sealed Polycarbonate Lens & Base

| Part No.       | Colour | Function     | SAE | Amp Draw |
|----------------|--------|--------------|-----|----------|
| <b>SE1040C</b> | Clear  | Utility/Dome | -   | 0.33     |

For Retail Bag, Add the nomenclature 'P' to the end of each Part No.

**Pigtails** PT6020 / PT6022  
**Base Mounts w/ Ground** BM1040B / BM1040BB / BM1040BC



| INCANDESCENT KITS |   |
|-------------------|---|
| <b>KT2140C</b>    | Incandescent • Gray Base Mount w/ Built-In Ground & Hotwire   |
| <b>KT2142C</b>    | Incandescent • Black Base Mount w/ Built-In Ground & Hotwire  |
| <b>KT2143C</b>    | Incandescent • Chrome Base Mount w/ Built-In Ground & Hotwire |



# TRADITIONAL LAMPS

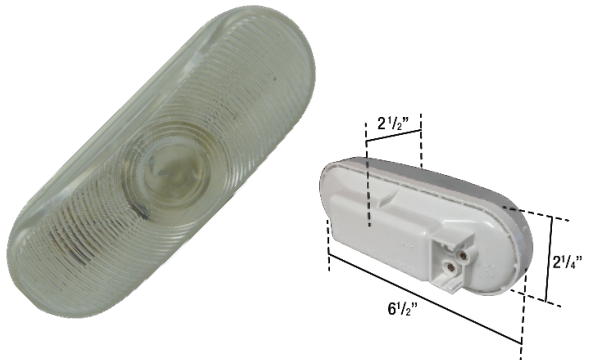

**6" Oval Incandescent Series** **12V**  
Sealed Polycarbonate Lens & Base



| Part No.       | Colour | Function     | SAE | Amp Draw |
|----------------|--------|--------------|-----|----------|
| <b>SE2238C</b> | Clear  | Utility/Dome | -   | 0.48     |

For Retail Bag, Add the nomenclature 'P' to the end of each Part No.

- Grommets** GR2238, GR2239
- Pigtails** PT9530, PT9532, PT9180, PT9182
- Mounting Brackets** MB2238
- Decorative Bezels** BZ2238, BZ2238V

| LED DOME / UTILITY KITS |  |
|-------------------------|--|
| <b>SEF2238C-0</b>       | Clear • White ABS Flange   |
| <b>SEF2238C-1</b>       | Clear • Black ABS Flange   |
| <b>SEF2238C-2</b>       | Clear • Gray ABS Flange  |
| <b>SEF2238C-5</b>       | Clear • Chrome ABS Flange  |
| <b>KT3260C</b>          | Clear • Open Grommet • Double Contact Pigtail                            |
| <b>KT3261C</b>          | Clear • Closed Grommet • Double Contact Pigtail                          |
| <b>KTM2239C</b>         | Clear • Closed Grommet • Double Contact Pigtail • Steel Mounting Bracket |



**6" Oval 24 Diodes Series** **12V**  
Sealed Polycarbonate Lens & Base



| Part No.           | Colour | Function     | SAE | Amp Draw |
|--------------------|--------|--------------|-----|----------|
| <b>LDL2238-24C</b> | White  | Utility/Dome | -   | 0.4      |

For Retail Bag, Add the nomenclature 'P' to the end of each Part No.

- Grommets** GR2238, GR2239
- Pigtails** PT9530, PT9532, PT9180, PT9182
- Mounting Brackets** MB2238
- Decorative Bezels** BZ2238, BZ2238V

| LED DOME / UTILITY KITS |   |
|-------------------------|---|
| <b>KDL2238-24C</b>      | White • Open Grommet • Double Contact Pigtail |



# LED LIGHT STRIPS



## Silicone Coated (3-Pin Type)

| Part No.  | LDS04206P          | LDS04120RP      | LDS04120R-5P    |
|-----------|--------------------|-----------------|-----------------|
| Length    | 20"                | 12"             | 12"             |
| Lumens    | 630                | 36              | 36              |
| Colour    | Day White          | Red             | Red             |
| Qty       | 1 pc               | 1 pc            | 5 pcs           |
| LED       | 30 Diodes          | 12 Diodes       | 12 Diodes       |
| Amp Draw  | 0.8 @ 12V          | 0.3 @ 12V       | 0.3 @ 12V       |
| Dimension | 20.25" L x 0.44" W | 12" L x 0.44" W | 12" L x 0.44" W |

For Kits with Power Cable, replace the suffix 'P' with the suffix 'K' at the end of each Part No.

| Voltage | Housing          | Mounting         | Connection Type | EMC       | FCC       |
|---------|------------------|------------------|-----------------|-----------|-----------|
| 12V     | Silicone Coating | 3M Adhesive Back | Pin             | Certified | Certified |

### ACCESSORIES

**Power Cable** LDS0470P  
**ON-OFF Switch** SW010P



## Aluminum Housing (3-Pin Type)

| Part No.            | LDS06127S         | LDS06207S         | LDS06407          | LDS06407S         | LDS06404S         |
|---------------------|-------------------|-------------------|-------------------|-------------------|-------------------|
| Length              | 12"               | 20"               | 40"               | 40"               | 40"               |
| Lumens              | 630               | 1050              | 1260              | 2100              | 2100              |
| Colour              | Cool White        | Cool White        | Cool White        | Cool White        | Neutral White     |
| Qty                 | 1 pc              | 1 pc              | 1 pc              | 1 pc              | 1 pc              |
| LED                 | 18 Diodes         | 30 Diodes         | 60 Diodes         | 60 Diodes         | 60 Diodes         |
| Amp Draw            | 0.7 @ 12V         | 1.1 @ 12V         | 2.1 @ 12V         | 2.1 @ 12V         | 2.1 @ 12V         |
| Dimension           | 12.6" L x 0.75" W | 20.5" L x 0.75" W | 40.2" L x 0.75" W | 40.2" L x 0.75" W | 40.2" L x 0.75" W |
| Mounting (INCLUDED) | YES               | YES               | YES               | YES               | YES               |

For Kits with Power Cable, add the suffix 'K' to the end of each Part No.

| Voltage | Housing                    | Lens     | Mounting    | Connection Type | EMC       |
|---------|----------------------------|----------|-------------|-----------------|-----------|
| 12V     | High UV Resistant Aluminum | Silicone | 2x Brackets | Pin             | Certified |

### ACCESSORIES

**Power Cable** LDS0670P  
**Mounting Brackets** LDS0675P  
**ON-OFF Switch** SW010P



# LED LIGHT STRIPS - OUTDOOR



## Aluminum Housing (3-Wire Type) - RED/WHITE

| Part No.  | LDS0612RW             | LDS0620RW             | LDS0640RW              |
|-----------|-----------------------|-----------------------|------------------------|
| Length    | 12"                   | 20"                   | 40"                    |
| Lumens    | RED: 240 / WHITE: 420 | RED: 360 / WHITE: 630 | RED: 720 / WHITE: 1260 |
| Colour    | Red / Cool White      | Red / Cool White      | Red / Cool White       |
| Qty       | 1 pc                  | 1 pc                  | 1 pc                   |
| LED       | 12 Diodes             | 18 Diodes             | 36 Diodes              |
| Amp Draw  | 0.6 @ 12V             | 0.8 @ 12V             | 1.4 @ 12V              |
| Dimension | 13.5" L x 0.75" W     | 20.1" L x 0.75" W     | 39.8" L x 0.75" W      |

Mounting Brackets (x2) are included for all Part No. above.

| Voltage | Housing                    | Lens     | Mounting    | Connection Type | EMC       |
|---------|----------------------------|----------|-------------|-----------------|-----------|
| 12V     | High UV Resistant Aluminum | Silicone | 2x Brackets | Lead Wire       | Certified |

### ACCESSORIES

|                   |          |
|-------------------|----------|
| Mounting Brackets | LDS0675P |
| ON-OFF Switch     | SW010P   |



## Aluminum Housing (2-Wire Type) - WHITE

| Part No.  | LDS061275-1        | LDS062075-1       | LDS064075-1       |
|-----------|--------------------|-------------------|-------------------|
| Length    | 12"                | 20"               | 40"               |
| Lumens    | 630                | 1050              | 2100              |
| Colour    | Cool White         | Cool White        | Cool White        |
| Qty       | 1 pc               | 1 pc              | 1 pc              |
| LED       | 18 Diodes          | 30 Diodes         | 60 Diodes         |
| Amp Draw  | 0.8 @ 12V          | 1.2 @ 12V         | 2.1 @ 12V         |
| Dimension | 12.25" L x 0.75" W | 20.1" L x 0.75" W | 39.8" L x 0.75" W |

Mounting Brackets (x2) are included for all Part No. above.

| Voltage | Housing                    | Lens     | Mounting    | Connection Type | EMC       |
|---------|----------------------------|----------|-------------|-----------------|-----------|
| 12V     | High UV Resistant Aluminum | Silicone | 2x Brackets | Lead Wire       | Certified |

### ACCESSORIES

|                   |          |
|-------------------|----------|
| Mounting Brackets | LDS0675P |
| ON-OFF Switch     | SW010P   |

# 6" OVAL LED LAMPS

Sealed lamps are hermetically sealed to keep out road contaminants and moisture. Connections are plated to resist corrosion, internally soldered and compatible with industry pigtailed. All lamps are compliant to DOT FMVSS108 standards & MOT CMVSS108 safety standards and are coded accordingly.

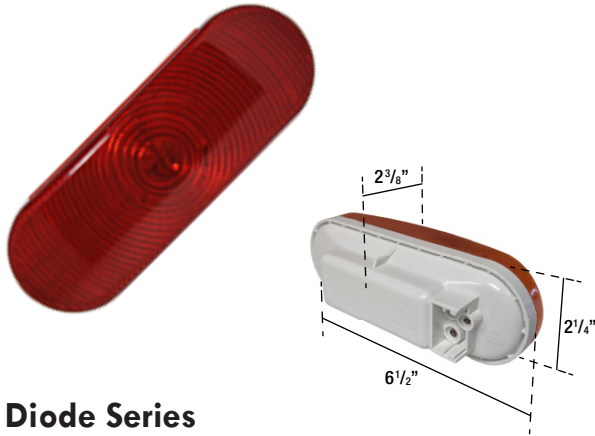

## 1 Diode Series

Sealed Acrylic Lens & ABS Base • 12V

| Part No.          | Colour | Function            | SAE  | Amp Draw |
|-------------------|--------|---------------------|------|----------|
| <b>LED2238-1A</b> | Amber  | Signal/Park         | IP   | 0.03/0.3 |
| <b>LED2238-1R</b> | Red    | Stop/Turn/Tail/Park | STIP | 0.03/0.3 |
| <b>LED2238-1C</b> | Clear  | Back Up             | 2R   | 0.3      |

For Retail Bag, add the suffix 'P' to the end of the Part No.

|                          |                                |
|--------------------------|--------------------------------|
| <b>Grommets</b>          | GR2238, GR2239                 |
| <b>Pigtails</b>          | PT9530, PT9532, PT9180, PT9182 |
| <b>Mounting Brackets</b> | MB2238                         |
| <b>Decorative Bezels</b> | BZ2238, BZ2238V                |



| SIGNAL / PARK KITS  |  |
|---------------------|--|
| <b>LEDF2238-1A1</b> | Amber • Black ABS Flange   |
| <b>KTL2238-1A</b>   | Amber • Open Grommet • Double Contact Pigtail                            |
| <b>KTL2239-1A</b>   | Amber • Closed Grommet • Double Contact Pigtail                          |
| <b>KTLM2239-1A</b>  | Amber • Closed Grommet • Double Contact Pigtail • Steel Mounting Bracket |

| STOP / TURN / TAIL / PARK KITS |  |
|--------------------------------|--|
| <b>LEDF2238-1R1</b>            | Red • Black ABS Flange   |
| <b>KTL2238-1R</b>              | Red • Open Grommet • Double Contact Pigtail                            |
| <b>KTL2239-1R</b>              | Red • Closed Grommet • Double Contact Pigtail                          |
| <b>KTLM2239-1R</b>             | Red • Closed Grommet • Double Contact Pigtail • Steel Mounting Bracket |

| BACK UP KITS        |  |
|---------------------|--|
| <b>LEDF2238-1C1</b> | Clear • Black ABS Flange   |
| <b>KTL2238-1C</b>   | Clear • Open Grommet • Double Contact Pigtail                            |
| <b>KTL2239-1C</b>   | Clear • Closed Grommet • Double Contact Pigtail                          |
| <b>KTLM2239-1C</b>  | Clear • Closed Grommet • Double Contact Pigtail • Steel Mounting Bracket |

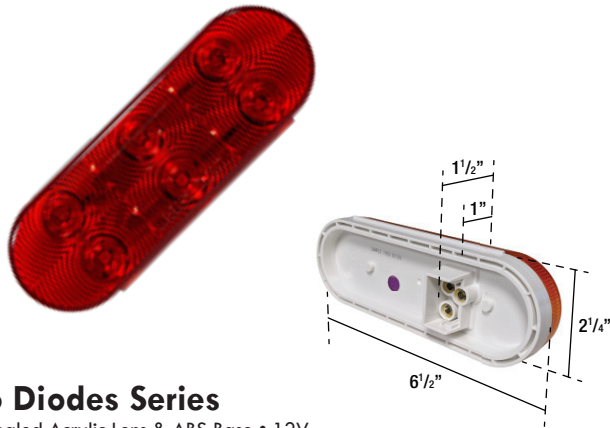

## 6 Diodes Series

Sealed Acrylic Lens & ABS Base • 12V

| Part No.          | Colour | Function            | SAE       | Amp Draw  |
|-------------------|--------|---------------------|-----------|-----------|
| <b>LED2238-6A</b> | Amber  | Signal/Park         | I6P       | 0.01/0.18 |
| <b>LED2238-6R</b> | Red    | Stop/Turn/Tail/Park | S216 (3)T | 0.01/0.18 |
| <b>LED2238-6C</b> | Clear  | Back Up             | 2R        | 0.08      |

For Retail Bag, add the suffix 'P' to the end of the Part No.

|                          |                                |
|--------------------------|--------------------------------|
| <b>Grommets</b>          | GR2238, GR2239                 |
| <b>Pigtails</b>          | PT9530, PT9532, PT9180, PT9182 |
| <b>Mounting Brackets</b> | MB2238                         |
| <b>Decorative Bezels</b> | BZ2238, BZ2238V                |



| SIGNAL / PARK KITS  |  |
|---------------------|--|
| <b>LEDF2238-6A1</b> | Amber • Black ABS Flange   |
| <b>KTL2238-6A</b>   | Amber • Open Grommet • Double Contact Pigtail                            |
| <b>KTL2239-6A</b>   | Amber • Closed Grommet • Double Contact Pigtail                          |
| <b>KTLM2239-6A</b>  | Amber • Closed Grommet • Double Contact Pigtail • Steel Mounting Bracket |

| STOP / TURN / TAIL / PARK KITS |  |
|--------------------------------|--|
| <b>LEDF2238-6R1</b>            | Red • Black ABS Flange   |
| <b>KTL2238-6R</b>              | Red • Open Grommet • Double Contact Pigtail                            |
| <b>KTL2239-6R</b>              | Red • Closed Grommet • Double Contact Pigtail                          |
| <b>KTLM2239-6R</b>             | Red • Closed Grommet • Double Contact Pigtail • Steel Mounting Bracket |

| BACK UP KITS        |  |
|---------------------|--|
| <b>LEDF2238-6C1</b> | Clear • Black ABS Flange   |
| <b>KTL2238-6C</b>   | Clear • Open Grommet • Double Contact Pigtail                            |
| <b>KTL2239-6C</b>   | Clear • Closed Grommet • Double Contact Pigtail                          |
| <b>KTLM2239-6C</b>  | Clear • Closed Grommet • Double Contact Pigtail • Steel Mounting Bracket |



# 6" OVAL LED LAMPS

STOP / TURN / TAIL / BACK UP LAMPS  
FEUX DE CHANGEMENT DE DIRECTION / ARRÊT / ARRIÈRE / RECUL

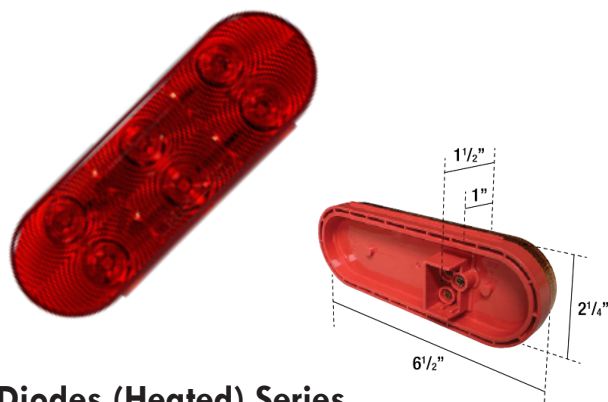

## 6 Diodes (Heated) Series

Sealed Polycarbonate Lens & Base • 12V

| Part No.           | Colour | Function       | SAE        | Amp Draw |
|--------------------|--------|----------------|------------|----------|
| <b>LED2238H-6A</b> | Amber  | Signal         | I6         | 0.8      |
| <b>LED2238H-6R</b> | Red    | Stop/Turn/Tail | S2716 (3)T | 0.2/0.5  |
| <b>LED2238H-6C</b> | Clear  | Back Up        | 2R         | 0.6      |

For Retail Bag, add the suffix 'P' to the end of the Part No.

|                          |                                |
|--------------------------|--------------------------------|
| <b>Grommets</b>          | GR2238, GR2239                 |
| <b>Pigtails</b>          | PT9530, PT9532, PT9180, PT9182 |
| <b>Mounting Brackets</b> | MB2238                         |
| <b>Decorative Bezels</b> | BZ2238, BZ2238V                |



| SIGNAL / PARK KITS   |  |
|----------------------|--|
| <b>LEDF2238H-6A1</b> | Amber • Black ABS Flange   |
| <b>KTL2238H-6A</b>   | Amber • Open Grommet • Double Contact Pigtail                            |
| <b>KTL2239H-6A</b>   | Amber • Closed Grommet • Double Contact Pigtail                          |
| <b>KTLM2239H-6A</b>  | Amber • Closed Grommet • Double Contact Pigtail • Steel Mounting Bracket |

| STOP / TURN / TAIL / PARK KITS |  |
|--------------------------------|--|
| <b>LEDF2238H-6R1</b>           | Red • Black ABS Flange   |
| <b>KTL2238H-6R</b>             | Red • Open Grommet • Double Contact Pigtail                            |
| <b>KTL2239H-6R</b>             | Red • Closed Grommet • Double Contact Pigtail                          |
| <b>KTLM2239H-6R</b>            | Red • Closed Grommet • Double Contact Pigtail • Steel Mounting Bracket |

| BACK UP KITS         |  |
|----------------------|--|
| <b>LEDF2238H-6C1</b> | Clear • Black ABS Flange   |
| <b>KTL2238H-6C</b>   | Clear • Open Grommet • Double Contact Pigtail                            |
| <b>KTL2239H-6C</b>   | Clear • Closed Grommet • Double Contact Pigtail                          |
| <b>KTLM2239H-6C</b>  | Clear • Closed Grommet • Double Contact Pigtail • Steel Mounting Bracket |

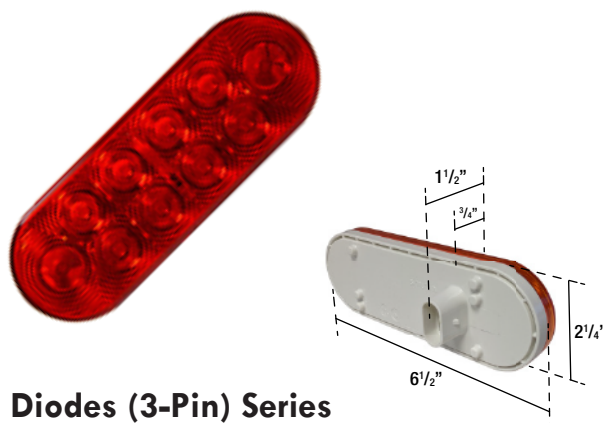

## 10 Diodes (3-Pin) Series

Sealed Acrylic Lens & ABS Base • 12V

| Part No.            | Colour | Function       | SAE    | Amp Draw  |
|---------------------|--------|----------------|--------|-----------|
| <b>LED2238G-10A</b> | Amber  | Signal/Park    | I6P    | 0.03/0.21 |
| <b>LED2238G-10R</b> | Red    | Stop/Turn/Tail | S2T216 | 0.02/0.11 |
| <b>LED2238G-10C</b> | Clear  | Back Up        | 2R     | 0.1       |

For Retail Bag, add the suffix 'P' to the end of the Part No.

|                          |                 |
|--------------------------|-----------------|
| <b>Grommets</b>          | GR2238, GR2239  |
| <b>Pigtails</b>          | PT9181-1        |
| <b>Mounting Brackets</b> | MB2238          |
| <b>Decorative Bezels</b> | BZ2238, BZ2238V |



| SIGNAL / PARK KITS    |  |
|-----------------------|--|
| <b>LEDF2238G-10A1</b> | Amber • Black ABS Flange   |
| <b>KTL2238G-10A</b>   | Amber • Open Grommet • Weatherproof Pigtail                            |
| <b>KTL2239G-10A</b>   | Amber • Closed Grommet • Weatherproof Pigtail                          |
| <b>KTLM2239G-10A</b>  | Amber • Closed Grommet • Weatherproof Pigtail • Steel Mounting Bracket |

| STOP / TURN / TAIL / PARK KITS |  |
|--------------------------------|--|
| <b>LEDF2238G-10R1</b>          | Red • Black ABS Flange   |
| <b>KTL2238G-10R</b>            | Red • Open Grommet • Weatherproof Pigtail                            |
| <b>KTL2239G-10R</b>            | Red • Closed Grommet • Weatherproof Pigtail                          |
| <b>KTLM2239G-10R</b>           | Red • Closed Grommet • Weatherproof Pigtail • Steel Mounting Bracket |

| BACK UP KITS          |  |
|-----------------------|--|
| <b>LEDF2238G-10C1</b> | Clear • Black ABS Flange   |
| <b>KTL2238G-10C</b>   | Clear • Open Grommet • Weatherproof Pigtail                            |
| <b>KTL2239G-10C</b>   | Clear • Closed Grommet • Weatherproof Pigtail                          |
| <b>KTLM2239G-10C</b>  | Clear • Closed Grommet • Weatherproof Pigtail • Steel Mounting Bracket |

# 6" OVAL LED LAMPS

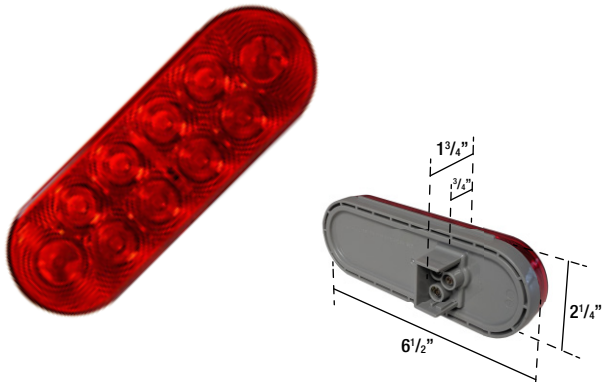

## 10 Diode (Multi-Voltage) Series

Sealed Acrylic Lens & ABS Base

**MULTI-VOLTAGE**  
**12V - 24V**

| Part No.            | Colour | Function       | SAE   | Amp Draw  |
|---------------------|--------|----------------|-------|-----------|
| <b>LED2238M-10R</b> | Red    | Stop/Turn/Tail | S2T16 | 0.02/0.11 |

For Retail Bag, add the suffix 'P' to the end of the Part No.

|                          |                                |
|--------------------------|--------------------------------|
| <b>Grommets</b>          | GR2238, GR2239                 |
| <b>Pigtails</b>          | PT9530, PT9532, PT9180, PT9182 |
| <b>Mounting Brackets</b> | MB2238                         |
| <b>Decorative Bezels</b> | BZ2238, BZ2238V                |

| STOP / TURN / TAIL / PARK KITS |  |
|--------------------------------|--|
| <b>LEDF2238M-10R1</b>          | Red • Black ABS Flange   |
| <b>KTL2238M-10R</b>            | Red • Open Grommet • Double Contact Pigtail                            |
| <b>KTL2239M-10R</b>            | Red • Closed Grommet • Double Contact Pigtail                          |
| <b>KTLM2239M-10R</b>           | Red • Closed Grommet • Double Contact Pigtail • Steel Mounting Bracket |

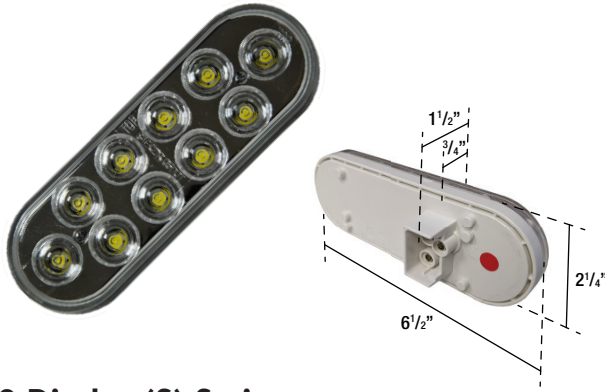

## 10 Diodes (S) Series

Sealed Acrylic Lens & ABS Base • 12V

| Part No.            | Colour | Function       | SAE       | Amp Draw  |
|---------------------|--------|----------------|-----------|-----------|
| <b>LED2238S-10A</b> | Amber  | Signal/Park    | I6P       | 0.03/0.21 |
| <b>LED2238S-10R</b> | Red    | Stop/Turn/Tail | I6S2 (3T) | 0.02/0.11 |

### CLEAR LENS LAMPS

|                      |       |                |           |           |
|----------------------|-------|----------------|-----------|-----------|
| <b>LED2238CS-10A</b> | Amber | Signal/Park    | I6P       | 0.03/0.21 |
| <b>LED2238CS-10R</b> | Red   | Stop/Turn/Tail | I6S2 (3T) | 0.02/0.11 |

For Retail Bag, add the suffix 'P' to the end of the Part No.

|                          |                                |
|--------------------------|--------------------------------|
| <b>Grommets</b>          | GR2238, GR2239                 |
| <b>Pigtails</b>          | PT9530, PT9532, PT9180, PT9182 |
| <b>Mounting Brackets</b> | MB2238                         |
| <b>Decorative Bezels</b> | BZ2238, BZ2238V                |

| SIGNAL / PARK KITS    |  |
|-----------------------|--|
| <b>LEDF2238S-10A0</b> | Amber • White ABS Flange   |
| <b>LEDF2238S-10A1</b> | Amber • Black ABS Flange   |
| <b>LEDF2238S-10A2</b> | Amber • Gray ABS Flange  |
| <b>LEDF2238S-10A5</b> | Amber • Chrome ABS Flange  |
| <b>KTL2238S-10A</b>   | Amber • Open Grommet • Double Contact Pigtail                            |
| <b>KTL2239S-10A</b>   | Amber • Closed Grommet • Double Contact Pigtail                          |
| <b>KTLM2239S-10A</b>  | Amber • Closed Grommet • Double Contact Pigtail • Steel Mounting Bracket |

| STOP / TURN / TAIL / PARK KITS |  |
|--------------------------------|--|
| <b>LEDF2238S-10R0</b>          | Red • White ABS Flange   |
| <b>LEDF2238S-10R1</b>          | Red • Black ABS Flange   |
| <b>LEDF2238S-10R2</b>          | Red • Gray ABS Flange  |
| <b>LEDF2238S-10R5</b>          | Red • Chrome ABS Flange  |
| <b>KTL2238S-10R</b>            | Red • Open Grommet • Double Contact Pigtail                            |
| <b>KTL2239S-10R</b>            | Red • Closed Grommet • Double Contact Pigtail                          |
| <b>KTLM2239S-10R</b>           | Red • Closed Grommet • Double Contact Pigtail • Steel Mounting Bracket |

| SIGNAL / PARK KITS - CLEAR LENS |  |
|---------------------------------|--|
| <b>LEDF2238CS-10A0</b>          | Amber • White ABS Flange   |
| <b>LEDF2238CS-10A1</b>          | Amber • Black ABS Flange   |
| <b>LEDF2238CS-10A2</b>          | Amber • Gray ABS Flange  |
| <b>LEDF2238CS-10A5</b>          | Amber • Chrome ABS Flange  |
| <b>KTL2238CS-10A</b>            | Amber • Open Grommet • Double Contact Pigtail                            |
| <b>KTL2239CS-10A</b>            | Amber • Closed Grommet • Double Contact Pigtail                          |
| <b>KTLM2239CS-10A</b>           | Amber • Closed Grommet • Double Contact Pigtail • Steel Mounting Bracket |

| STOP / TURN / TAIL / PARK KITS - CLEAR LENS |  |
|---|--|
| <b>LEDF2238CS-10R0</b>                      | Red • White ABS Flange   |
| <b>LEDF2238CS-10R1</b>                      | Red • Black ABS Flange   |
| <b>LEDF2238CS-10R2</b>                      | Red • Gray ABS Flange  |
| <b>LEDF2238CS-10R5</b>                      | Red • Chrome ABS Flange  |
| <b>KTL2238CS-10R</b>                        | Red • Open Grommet • Double Contact Pigtail                            |
| <b>KTL2239CS-10R</b>                        | Red • Closed Grommet • Double Contact Pigtail                          |
| <b>KTLM2239CS-10R</b>                       | Red • Closed Grommet • Double Contact Pigtail • Steel Mounting Bracket |



# 6" OVAL LED LAMPS

STOP / TURN / TAIL / BACK UP LAMPS  
FEUX DE CHANGEMENT DE DIRECTION / ARRÊT / ARRIÈRE / RECUL

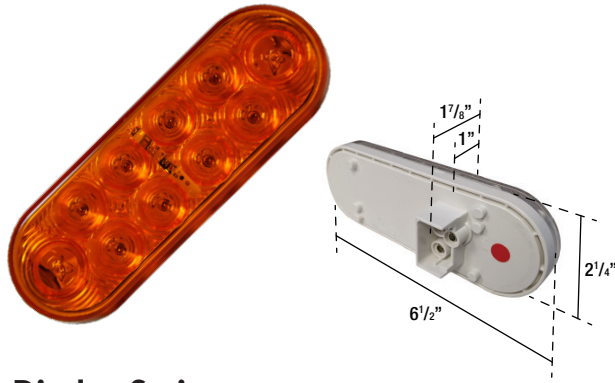

## 10 Diodes Series

Sealed Polycarbonate Lens & ABS Base • 12V

| Part No.           | Colour | Function       | SAE    | Amp Draw  |
|--------------------|--------|----------------|--------|-----------|
| <b>LED2238-10A</b> | Amber  | Signal/Park    | I6P    | 0.03/0.21 |
| <b>LED2238-10R</b> | Red    | Stop/Turn/Tail | S2T2I6 | 0.02/0.11 |
| <b>LED2238-10C</b> | Clear  | Back Up        | 2R     | 0.18      |

### CLEAR LENS LAMPS

|                     |       |                |        |           |
|---------------------|-------|----------------|--------|-----------|
| <b>LED2238C-10A</b> | Amber | Signal/Park    | I6P    | 0.03/0.21 |
| <b>LED2238C-10R</b> | Red   | Stop/Turn/Tail | S2T2I6 | 0.02/0.11 |

For Retail Bag, add the suffix 'P' to the end of the Part No.

|                          |                                |
|--------------------------|--------------------------------|
| <b>Grommets</b>          | GR2238, GR2239                 |
| <b>Pigtails</b>          | PT9530, PT9532, PT9180, PT9182 |
| <b>Mounting Brackets</b> | MB2238                         |
| <b>Decorative Bezels</b> | BZ2238, BZ2238V                |

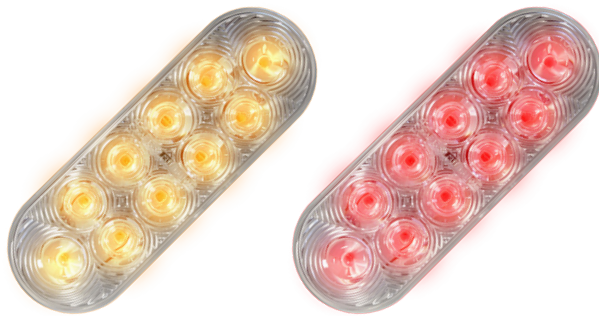

| SIGNAL / PARK KITS   |  |
|----------------------|--|
| <b>LEDF2238-10A0</b> | Amber • White ABS Flange   |
| <b>LEDF2238-10A1</b> | Amber • Black ABS Flange   |
| <b>LEDF2238-10A2</b> | Amber • Gray ABS Flange  |
| <b>LEDF2238-10A5</b> | Amber • Chrome ABS Flange  |
| <b>KTL2238-10A</b>   | Amber • Open Grommet • Double Contact Pigtail                            |
| <b>KTL2239-10A</b>   | Amber • Closed Grommet • Double Contact Pigtail                          |
| <b>KTLM2239-10A</b>  | Amber • Closed Grommet • Double Contact Pigtail • Steel Mounting Bracket |

| STOP / TURN / TAIL KITS |  |
|-------------------------|--|
| <b>LEDF2238-10R0</b>    | Red • White ABS Flange   |
| <b>LEDF2238-10R1</b>    | Red • Black ABS Flange   |
| <b>LEDF2238-10R2</b>    | Red • Gray ABS Flange  |
| <b>LEDF2238-10R5</b>    | Red • Chrome ABS Flange  |
| <b>KTL2238-10R</b>      | Red • Open Grommet • Double Contact Pigtail                            |
| <b>KTL2239-10R</b>      | Red • Closed Grommet • Double Contact Pigtail                          |
| <b>KTLM2239-10R</b>     | Red • Closed Grommet • Double Contact Pigtail • Steel Mounting Bracket |

| BACK UP KITS         |  |
|----------------------|--|
| <b>LEDF2238-10C0</b> | Clear • White ABS Flange   |
| <b>LEDF2238-10C1</b> | Clear • Black ABS Flange   |
| <b>LEDF2238-10C2</b> | Clear • Gray ABS Flange  |
| <b>LEDF2238-10C5</b> | Clear • Chrome ABS Flange  |
| <b>KTL2238-10C</b>   | Clear • Open Grommet • Double Contact Pigtail                            |
| <b>KTL2239-10C</b>   | Clear • Closed Grommet • Double Contact Pigtail                          |
| <b>KTLM2239-10C</b>  | Clear • Closed Grommet • Double Contact Pigtail • Steel Mounting Bracket |

| SIGNAL / PARK KITS - CLEAR LENS |  |
|---------------------------------|--|
| <b>LEDF2238C-10A0</b>           | Amber • White ABS Flange   |
| <b>LEDF2238C-10A1</b>           | Amber • Black ABS Flange   |
| <b>LEDF2238C-10A2</b>           | Amber • Gray ABS Flange  |
| <b>LEDF2238C-10A5</b>           | Amber • Chrome ABS Flange  |
| <b>KTL2238C-10A</b>             | Amber • Open Grommet • Double Contact Pigtail                            |
| <b>KTL2239C-10A</b>             | Amber • Closed Grommet • Double Contact Pigtail                          |
| <b>KTLM2239C-10A</b>            | Amber • Closed Grommet • Double Contact Pigtail • Steel Mounting Bracket |

| STOP / TURN / TAIL KITS - CLEAR LENS |  |
|--------------------------------------|--|
| <b>LEDF2238C-10R0</b>                | Red • White ABS Flange   |
| <b>LEDF2238C-10R1</b>                | Red • Black ABS Flange   |
| <b>LEDF2238C-10R2</b>                | Red • Gray ABS Flange  |
| <b>LEDF2238C-10R5</b>                | Red • Chrome ABS Flange  |
| <b>KTL2238C-10R</b>                  | Red • Open Grommet • Double Contact Pigtail                            |
| <b>KTL2239C-10R</b>                  | Red • Closed Grommet • Double Contact Pigtail                          |
| <b>KTLM2239C-10R</b>                 | Red • Closed Grommet • Double Contact Pigtail • Steel Mounting Bracket |



# 6" OVAL LED LAMPS



## 10 Diodes (Surface Mount) Series

Lamps comes with 3 wires (no pigtail required). Surface mount installation eliminates the need to cut mounting hole and does not require grommets.

Sealed Acrylic Lens & ABS Base • 12V

| Part No.            | Colour | Function       | SAE    | Amp Draw  |
|---------------------|--------|----------------|--------|-----------|
| <b>LEDS2238-10A</b> | Amber  | Signal/Park    | I6P    | 0.03/0.21 |
| <b>LEDS2238-10R</b> | Red    | Stop/Turn/Tail | S2T2I6 | 0.03/0.11 |
| <b>LEDS2238-10C</b> | Clear  | Back Up        | 2R     | 0.18      |

For Retail Bag, add the suffix 'P' to the end of the Part No.

**Decorative Bezels** BZ2238-5S

| SIGNAL / PARK KITS |                      |
|--------------------|----------------------|
| <b>KTS2238-10A</b> | Amber • Chrome Bezel |

| STOP / TURN / TAIL / PARK KITS |                    |
|--------------------------------|--------------------|
| <b>KTS2238-10R</b>             | Red • Chrome Bezel |

| BACK UP KITS       |                      |
|--------------------|----------------------|
| <b>KTS2238-10C</b> | Clear • Chrome Bezel |

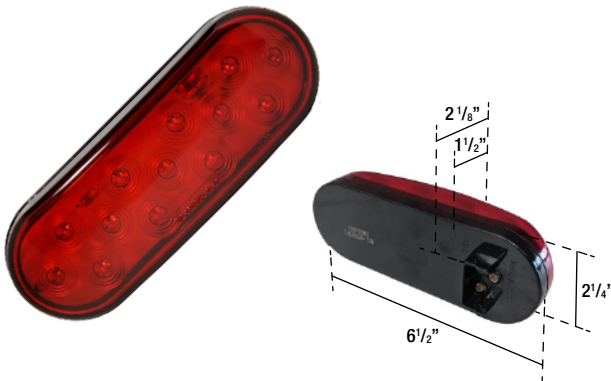

## 13 Diodes Series

Sealed Polycarbonate Lens & Base • 12V

| Part No.           | Colour | Function       | SAE | Amp Draw  |
|--------------------|--------|----------------|-----|-----------|
| <b>LED2238-13R</b> | Red    | Stop/Turn/Tail | STI | 0.01/0.12 |

For Retail Bag, add the suffix 'P' to the end of the Part No.

**Grommets** GR2238, GR2239  
**Pigtails** PT9530, PT9532, PT9180, PT9182  
**Mounting Brackets** MB2238  
**Decorative Bezels** BZ2238, BZ2238V

| STOP / TURN / TAIL / PARK KITS |  |
|--------------------------------|--|
| <b>LEDF2238-13R0</b>           | Red • White ABS Flange   |
| <b>LEDF2238-13R1</b>           | Red • Black ABS Flange   |
| <b>LEDF2238-13R2</b>           | Red • Gray ABS Flange  |
| <b>LEDF2238-13R5</b>           | Red • Chrome ABS Flange  |
| <b>KTL2238-13R</b>             | Red • Open Grommet • Double Contact Pigtail                            |
| <b>KTL2239-13R</b>             | Red • Closed Grommet • Double Contact Pigtail                          |
| <b>KTLM2239-13R</b>            | Red • Closed Grommet • Double Contact Pigtail • Steel Mounting Bracket |



# 6" OVAL LED LAMPS

STOP / TURN / TAIL / BACK UP LAMPS  
FEUX DE CHANGEMENT DE DIRECTION / ARRÊT / ARRIÈRE / RECUL

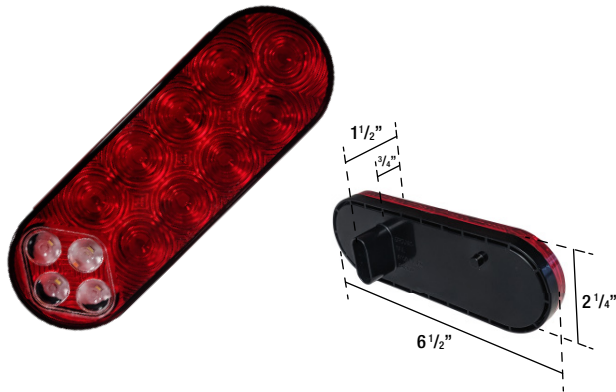

## 14 Diodes (4-Pin) Series

LED: 10 Stop/Turn/Tail + 4 Back Up  
Sealed Acrylic Lens & ABS Base • 12V

| Part No.             | Colour       | Function                   | SAE     | Amp Draw  |
|----------------------|--------------|----------------------------|---------|-----------|
| <b>LED2238G-14RW</b> | Red<br>White | Stop/Turn/Tail/<br>Back Up | STI(2)R | 0.02/0.27 |

For Retail Bag, add the suffix 'P' to the end of the Part No.

|                   |                 |
|-------------------|-----------------|
| Grommets          | GR2238, GR2239  |
| Pigtails          | PT9181-4        |
| Mounting Brackets | MB2238          |
| Decorative Bezels | BZ2238, BZ2238V |

| STOP / TURN / TAIL / PARK KITS |   |
|--------------------------------|---|
| <b>LEDF2238G-14RW1</b>         | Lamp • Black ABS Flange   |
| <b>KTL2238G-14RW</b>           | Lamp • Open Grommet • Weatherproof Pigtail                            |
| <b>KTL2239G-14RW</b>           | Lamp • Closed Grommet • Weatherproof Pigtail                          |
| <b>KTLM2239G-14RW</b>          | Lamp • Closed Grommet • Weatherproof Pigtail • Steel Mounting Bracket |



**CLEAR & SAFE  
NO MATTER THE WEATHER**



## Heating Element

is thermostat controlled to ensure constant level of heat and to ensure over heating does not occur.

## Heated Tail Lamps

For More Info, Check Out  
Pg. 111 for 6" Ovals  
Pg. 120 for 4" Round



# 6" OVAL LED LAMPS

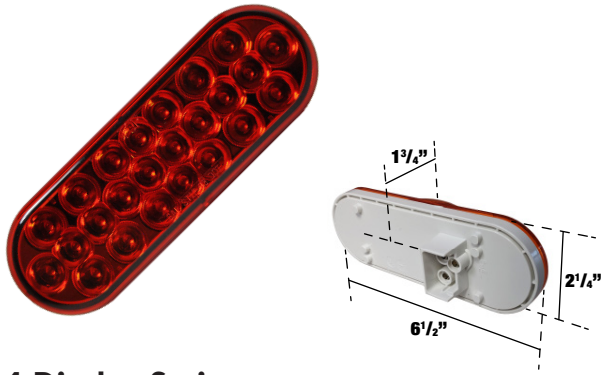

## 24 Diodes Series

Sealed Polycarbonate Lens & Base • 12V

| Part No.           | Colour | Function            | SAE  | Amp Draw  |
|--------------------|--------|---------------------|------|-----------|
| <b>LED2238-24A</b> | Amber  | Signal/Park         | IP   | 0.01/0.16 |
| <b>LED2238-24R</b> | Red    | Stop/Turn/Tail/Park | STIP | 0.01/0.20 |
| <b>LED2238-24C</b> | Clear  | Back Up             | 2R   | 0.09      |

### CLEAR LENS LAMPS

|                     |       |                     |      |           |
|---------------------|-------|---------------------|------|-----------|
| <b>LED2238C-24A</b> | Amber | Signal/Park         | IP   | 0.01/0.16 |
| <b>LED2238C-24R</b> | Red   | Stop/Turn/Tail/Park | STIP | 0.01/0.17 |

For Retail Bag, add the suffix 'P' to the end of the Part No.

|                          |                                |
|--------------------------|--------------------------------|
| <b>Grommets</b>          | GR2238, GR2239                 |
| <b>Pigtails</b>          | PT9530, PT9532, PT9180, PT9182 |
| <b>Mounting Brackets</b> | MB2238                         |
| <b>Decorative Bezels</b> | BZ2238, BZ2238V                |



| SIGNAL / PARK KITS   |  |
|----------------------|--|
| <b>LEDF2238-24A0</b> | Amber • White ABS Flange   |
| <b>LEDF2238-24A1</b> | Amber • Black ABS Flange   |
| <b>LEDF2238-24A2</b> | Amber • Gray ABS Flange  |
| <b>LEDF2238-24A5</b> | Amber • Chrome ABS Flange  |
| <b>KTL2238-24A</b>   | Amber • Open Grommet • Double Contact Pigtail                            |
| <b>KTL2239-24A</b>   | Amber • Closed Grommet • Double Contact Pigtail                          |
| <b>KTLM2239-24A</b>  | Amber • Closed Grommet • Double Contact Pigtail • Steel Mounting Bracket |

| STOP / TURN / TAIL KITS |  |
|-------------------------|--|
| <b>LEDF2238-24R0</b>    | Red • White ABS Flange   |
| <b>LEDF2238-24R1</b>    | Red • Black ABS Flange   |
| <b>LEDF2238-24R2</b>    | Red • Gray ABS Flange  |
| <b>LEDF2238-24R5</b>    | Red • Chrome ABS Flange  |
| <b>KTL2238-24R</b>      | Red • Open Grommet • Double Contact Pigtail                            |
| <b>KTL2239-24R</b>      | Red • Closed Grommet • Double Contact Pigtail                          |
| <b>KTLM2239-24R</b>     | Red • Closed Grommet • Double Contact Pigtail • Steel Mounting Bracket |

| BACK UP KITS         |  |
|----------------------|--|
| <b>LEDF2238-24C0</b> | Clear • White ABS Flange   |
| <b>LEDF2238-24C1</b> | Clear • Black ABS Flange   |
| <b>LEDF2238-24C2</b> | Clear • Gray ABS Flange  |
| <b>LEDF2238-24C5</b> | Clear • Chrome ABS Flange  |
| <b>KTL2238-24C</b>   | Clear • Open Grommet • Double Contact Pigtail                            |
| <b>KTL2239-24C</b>   | Clear • Closed Grommet • Double Contact Pigtail                          |
| <b>KTLM2239-24C</b>  | Clear • Closed Grommet • Double Contact Pigtail • Steel Mounting Bracket |

| SIGNAL / PARK KITS - CLEAR LENS |  |
|---------------------------------|--|
| <b>LEDF2238C-24A0</b>           | Amber • White ABS Flange   |
| <b>LEDF2238C-24A1</b>           | Amber • Black ABS Flange   |
| <b>LEDF2238C-24A2</b>           | Amber • Gray ABS Flange  |
| <b>LEDF2238C-24A5</b>           | Amber • Chrome ABS Flange  |
| <b>KTL2238C-24A</b>             | Amber • Open Grommet • Double Contact Pigtail                            |
| <b>KTL2239C-24A</b>             | Amber • Closed Grommet • Double Contact Pigtail                          |
| <b>KTLM2239C-24A</b>            | Amber • Closed Grommet • Double Contact Pigtail • Steel Mounting Bracket |

| STOP / TURN / TAIL KITS - CLEAR LENS |  |
|--------------------------------------|--|
| <b>LEDF2238C-24R0</b>                | Red • White ABS Flange   |
| <b>LEDF2238C-24R1</b>                | Red • Black ABS Flange   |
| <b>LEDF2238C-24R2</b>                | Red • Gray ABS Flange  |
| <b>LEDF2238C-24R5</b>                | Red • Chrome ABS Flange  |
| <b>KTL2238C-24R</b>                  | Red • Open Grommet • Double Contact Pigtail                            |
| <b>KTL2239C-24R</b>                  | Red • Closed Grommet • Double Contact Pigtail                          |
| <b>KTLM2239C-24R</b>                 | Red • Closed Grommet • Double Contact Pigtail • Steel Mounting Bracket |

# 6" SPECIALTY OVAL LAMPS

STOP / TURN / TAIL / BACK UP LAMPS  
FEUX DE CHANGEMENT DE DIRECTION / ARRÊT / ARRIÈRE / RECUL



## 22 Diodes (Combo) LED Series

5 Flash Patterns • IP67  
Sealed Acrylic Lens & ABS Base • 12V

| Part No.             | Colour         | Function                                      | SAE                      | Amp Draw |
|----------------------|----------------|---|--------------------------|----------|
| <b>LED2238E-22AW</b> | Amber<br>White | Stop/Turn/Tail/<br>Back Up<br>+ Warning Light | S2T2I6R<br>SAE<br>Class1 | 0.8      |

For Retail Bag, add the suffix 'P' to the end of the Part No.

**Grommets** GR2238, GR2239  
**Pigtails** PT9530, PT9532, PT9180, PT9182  
**Mounting Brackets** MB2238

| STOP / TURN / TAIL / PARK KITS |   |
|--------------------------------|---|
| <b>KTL2238E-22AW</b>           | Lamp • Open Grommet • Double Contact Pigtail                            |
| <b>KTL2239E-22AW</b>           | Lamp • Closed Grommet • Double Contact Pigtail                          |
| <b>KTLM2239E-22AW</b>          | Lamp • Closed Grommet • Double Contact Pigtail • Steel Mounting Bracket |

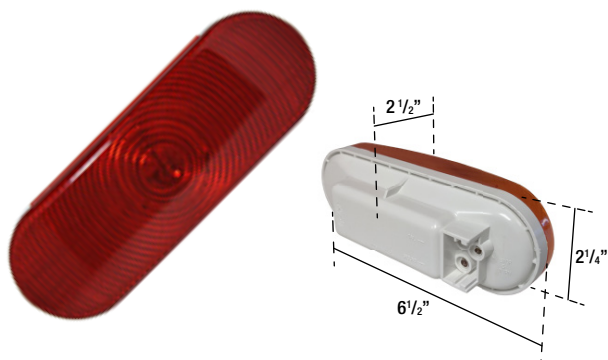

## Incandescent Series

Sealed Polycarbonate Lens & Base • 12V

| Part No.        | Colour | Function            | SAE  | Amp Draw  |
|-----------------|--------|---------------------|------|-----------|
| <b>SE2238A</b>  | Amber  | Signal/Park         | IP   | 0.48/2.10 |
| <b>SE2238R</b>  | Red    | Stop/Turn/Tail/Park | STIP | 0.48/2.10 |
| <b>SE2238WC</b> | Clear  | Back Up             | 2R   | 0.48      |

For Retail Bag, add the suffix 'P' to the end of the Part No.

**Grommets** GR2238, GR2239  
**Pigtails** PT9530, PT9532, PT9180, PT9182  
**Mounting Brackets** MB2238  
**Decorative Bezels** BZ2238, BZ2238V



| SIGNAL / PARK KITS |  |
|--------------------|--|
| <b>SEF2238A-0</b>  | Amber • White ABS Flange   |
| <b>SEF2238A-1</b>  | Amber • Black ABS Flange   |
| <b>SEF2238A-2</b>  | Amber • Gray ABS Flange  |
| <b>SEF2238A-5</b>  | Amber • Chrome ABS Flange  |
| <b>KT3260A</b>     | Amber • Open Grommet • Double Contact Pigtail                            |
| <b>KT3261A</b>     | Amber • Closed Grommet • Double Contact Pigtail                          |
| <b>KTM2239A</b>    | Amber • Closed Grommet • Double Contact Pigtail • Steel Mounting Bracket |

| STOP / TURN / TAIL / PARK KITS |  |
|--------------------------------|--|
| <b>SEF2238R-0</b>              | Red • White ABS Flange   |
| <b>SEF2238R-1</b>              | Red • Black ABS Flange   |
| <b>SEF2238R-2</b>              | Red • Gray ABS Flange  |
| <b>SEF2238R-5</b>              | Red • Chrome ABS Flange  |
| <b>KT3260R</b>                 | Red • Open Grommet • Double Contact Pigtail                            |
| <b>KT3261R</b>                 | Red • Closed Grommet • Double Contact Pigtail                          |
| <b>KTM2239R</b>                | Red • Closed Grommet • Double Contact Pigtail • Steel Mounting Bracket |

| BACK UP KITS       |  |
|--------------------|--|
| <b>SEF2238WC-0</b> | Clear • White ABS Flange   |
| <b>SEF2238WC-1</b> | Clear • Black ABS Flange   |
| <b>SEF2238WC-2</b> | Clear • Gray ABS Flange  |
| <b>SEF2238WC-5</b> | Clear • Chrome ABS Flange  |
| <b>KT3260WC</b>    | Clear • Open Grommet • Double Contact Pigtail                            |
| <b>KT3261WC</b>    | Clear • Closed Grommet • Double Contact Pigtail                          |
| <b>KTM2239WC</b>   | Clear • Closed Grommet • Double Contact Pigtail • Steel Mounting Bracket |

# 6" OVAL LAMPS - REFLECTIVE MID-TURN SIGNAL

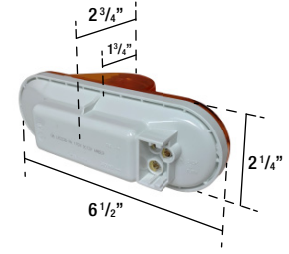
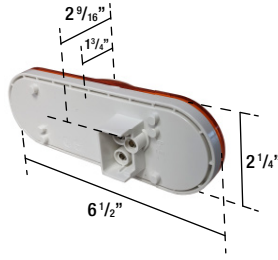

## 9 Diodes LED Reflective Mid-Turn Signal

| Part No.  | Colour | Function                                | SAE   | Amp Draw  |
|---|--------|---|-------|-----------|
| <b>For Vehicle Under 40ft in length</b><br>Sealed Polycarbonate Lens & Base • 12V |        |   |       |           |
| <b>LR2238-9A</b>  | Amber  | Mid Turn Reflector/<br>Clearance Marker | AE2P2 | 0.06/0.09 |

|  |       |   |      |          |
|--|-------|---|------|----------|
| <b>For Vehicle Over 40ft in length</b><br>Sealed Acrylic Lens & ABS Base • 12V |       |   |      |          |
| <b>LR2248-9A</b>   | Amber | Mid Turn Reflector/<br>Clearance Marker | AEP2 | 0.1/0.36 |

For Retail Bag, add the suffix 'P' to the end of the Part No.

|                          |                                |
|--------------------------|--------------------------------|
| <b>Grommets</b>          | GR2238, GR2239                 |
| <b>Pigtails</b>          | PT9530, PT9532, PT9180, PT9182 |
| <b>Mounting Brackets</b> | MB2238                         |
| <b>Decorative Bezels</b> | BZ2238, BZ2238V                |

| FOR VEHICLE UNDER 40FT KITS |   |
|-----------------------------|---|
| <b>KTLR2248-9A</b>          | Amber • Open Grommet • Double Contact Pigtail                               |
| <b>KTLR2249-9A</b>          | Amber • Closed Grommet • Double Contact Pigtail                             |
| <b>KTLRM2249-9A</b>         | Amber • Closed Grommet • Double Contact Pigtail<br>• Steel Mounting Bracket |

| FOR VEHICLE OVER 40FT KITS |   |
|----------------------------|---|
| <b>KTLR2248-9A</b>         | Amber • Open Grommet • Double Contact Pigtail                               |
| <b>KTLR2249-9A</b>         | Amber • Closed Grommet • Double Contact Pigtail                             |
| <b>KTLRM2249-9A</b>        | Amber • Closed Grommet • Double Contact Pigtail<br>• Steel Mounting Bracket |

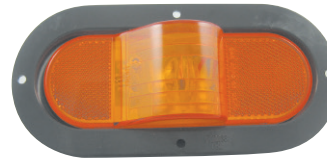
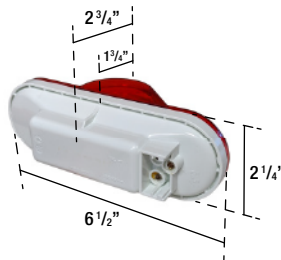

## Incandescent Reflective Mid-Turn Signal

**For Vehicle Over 40ft in length**  
Sealed Polycarbonate Lens & Base • 12V

| Part No.       | Colour | Function                                | SAE  | Amp Draw  |
|----------------|--------|---|------|-----------|
| <b>SR2238A</b> | Amber  | Mid Turn Reflector/<br>Clearance Marker | AEP2 | 0.48/2.10 |
| <b>SR2238R</b> | Red    | Mid Turn Reflector/<br>Clearance Marker | AEP2 | 0.48/2.10 |

For Retail Bag, add the suffix 'P' to the end of the Part No.

|                          |                                |
|--------------------------|--------------------------------|
| <b>Grommets</b>          | GR2238, GR2239                 |
| <b>Pigtails</b>          | PT9530, PT9532, PT9180, PT9182 |
| <b>Mounting Brackets</b> | MB2238                         |
| <b>Decorative Bezels</b> | BZ2238, BZ2238V                |

| AMBER KITS - FOR VEHICLE OVER 40FT |   |
|------------------------------------|---|
| <b>SRF2238A-0</b>                  | Amber • White ABS Flange  |
| <b>SRF2238A-1</b>                  | Amber • Black ABS Flange  |
| <b>SRF2238A-2</b>                  | Amber • Gray ABS Flange   |
| <b>SRF2238A-5</b>                  | Amber • Chrome ABS Flange   |
| <b>KTR2238A</b>                    | Amber • Open Grommet • Double Contact Pigtail                               |
| <b>KTR2239A</b>                    | Amber • Closed Grommet • Double Contact Pigtail                             |
| <b>KTMR2239A</b>                   | Amber • Closed Grommet • Double Contact Pigtail<br>• Steel Mounting Bracket |

| RED KITS - FOR VEHICLE OVER 40FT |   |
|----------------------------------|---|
| <b>SRF2238R-0</b>                | Red • White ABS Flange  |
| <b>SRF2238R-1</b>                | Red • Black ABS Flange  |
| <b>SRF2238R-2</b>                | Red • Gray ABS Flange   |
| <b>SRF2238R-5</b>                | Red • Chrome ABS Flange   |
| <b>KTR2238R</b>                  | Red • Open Grommet • Double Contact Pigtail                               |
| <b>KTR2239R</b>                  | Red • Closed Grommet • Double Contact Pigtail                             |
| <b>KTMR2239R</b>                 | Red • Closed Grommet • Double Contact Pigtail<br>• Steel Mounting Bracket |



# 4" ROUND LED LAMPS

STOP / TURN / TAIL / BACK UP LAMPS  
FEUX DE CHANGEMENT DE DIRECTION / ARRÊT / ARRIÈRE / RECUL

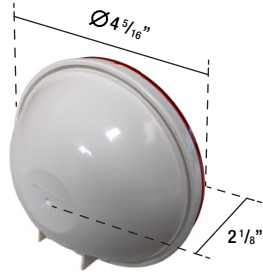

## 1 Diode Series

Sealed Acrylic Lens & ABS Base • 12V

| Part No.          | Colour | Function       | SAE | Amp Draw |
|-------------------|--------|----------------|-----|----------|
| <b>LED4000-1A</b> | Amber  | Signal         | I   | 0.19     |
| <b>LED4000-1R</b> | Red    | Stop/Turn/Tail | STI | 0.19/0.3 |
| <b>LED4000-1C</b> | Clear  | Back Up        | 2R  | 0.26     |

For Retail Bag, add the suffix 'P' to the end of the Part No.

|                          |                                |
|--------------------------|--------------------------------|
| <b>Grommets</b>          | GR4000, GR4001                 |
| <b>Pigtails</b>          | PT9530, PT9532, PT9180, PT9182 |
| <b>Mounting Brackets</b> | MB4000                         |
| <b>Decorative Bezels</b> | BZ4000, BZ4000V                |

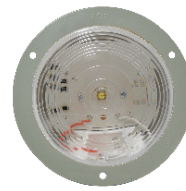

| SIGNAL KITS         |  |
|---------------------|--|
| <b>LEDF4000-1A1</b> | Amber • Black ABS Flange   |
| <b>LEDF4000-1A2</b> | Amber • Gray ABS Flange  |
| <b>LED4040-1A</b>   | Amber • Stainless Steel Flange   |
| <b>KTL4000-1A</b>   | Amber • Open Grommet • Double Contact Pigtail                            |
| <b>KTL4001-1A</b>   | Amber • Closed Grommet • Double Contact Pigtail                          |
| <b>KTLM4001-1A</b>  | Amber • Closed Grommet • Double Contact Pigtail • Steel Mounting Bracket |

| STOP / TURN / TAIL KITS |  |
|-------------------------|--|
| <b>LEDF4000-1R1</b>     | Red • Black ABS Flange   |
| <b>LEDF4000-1R2</b>     | Red • Gray ABS Flange  |
| <b>LED4040-1R</b>       | Red • Stainless Steel Flange   |
| <b>KTL4000-1R</b>       | Red • Open Grommet • Double Contact Pigtail                            |
| <b>KTL4001-1R</b>       | Red • Closed Grommet • Double Contact Pigtail                          |
| <b>KTLM4001-1R</b>      | Red • Closed Grommet • Double Contact Pigtail • Steel Mounting Bracket |

| BACK UP KITS        |  |
|---------------------|--|
| <b>LEDF4000-1C1</b> | Clear • Black ABS Flange   |
| <b>LEDF4000-1C2</b> | Clear • Gray ABS Flange  |
| <b>LED4040-1C</b>   | Clear • Stainless Steel Flange   |
| <b>KTL4000-1C</b>   | Clear • Open Grommet • Double Contact Pigtail                            |
| <b>KTL4001-1C</b>   | Clear • Closed Grommet • Double Contact Pigtail                          |
| <b>KTLM4001-1C</b>  | Clear • Closed Grommet • Double Contact Pigtail • Steel Mounting Bracket |



## 7 Diodes Series

Sealed Acrylic Lens & ABS Base • 12V

| Part No.          | Colour | Function            | SAE    | Amp Draw  |
|-------------------|--------|---------------------|--------|-----------|
| <b>LED4000-7A</b> | Amber  | Signal/Park         | I6P    | 0.01/0.17 |
| <b>LED4000-7R</b> | Red    | Stop/Turn/Tail/Park | S2I63T | 0.01/0.19 |
| <b>LED4000-7C</b> | Clear  | Back Up             | 2R     | 0.07      |

For Retail Bag, add the suffix 'P' to the end of the Part No.

|                          |                                |
|--------------------------|--------------------------------|
| <b>Grommets</b>          | GR4000, GR4001                 |
| <b>Pigtails</b>          | PT9530, PT9532, PT9180, PT9182 |
| <b>Mounting Brackets</b> | MB4000                         |
| <b>Decorative Bezels</b> | BZ4000, BZ4000V                |



| SIGNAL / PARK KITS  |  |
|---------------------|--|
| <b>LEDF4000-7A1</b> | Amber • Black ABS Flange   |
| <b>LEDF4000-7A2</b> | Amber • Gray ABS Flange  |
| <b>LED4040-7A</b>   | Amber • Stainless Steel Flange   |
| <b>KTL4000-7A</b>   | Amber • Open Grommet • Double Contact Pigtail                            |
| <b>KTL4001-7A</b>   | Amber • Closed Grommet • Double Contact Pigtail                          |
| <b>KTLM4001-7A</b>  | Amber • Closed Grommet • Double Contact Pigtail • Steel Mounting Bracket |

| STOP / TURN / TAIL KITS |  |
|-------------------------|--|
| <b>LEDF4000-7R1</b>     | Red • Black ABS Flange   |
| <b>LEDF4000-7R2</b>     | Red • Gray ABS Flange  |
| <b>LED4040-7R</b>       | Red • Stainless Steel Flange   |
| <b>KTL4000-7R</b>       | Red • Open Grommet • Double Contact Pigtail                            |
| <b>KTL4001-7R</b>       | Red • Closed Grommet • Double Contact Pigtail                          |
| <b>KTLM4001-7R</b>      | Red • Closed Grommet • Double Contact Pigtail • Steel Mounting Bracket |

| BACK UP KITS        |  |
|---------------------|--|
| <b>LEDF4000-7C1</b> | Clear • Black ABS Flange   |
| <b>LEDF4000-7C2</b> | Clear • Gray ABS Flange  |
| <b>LED4040-7C</b>   | Clear • Stainless Steel Flange   |
| <b>KTL4000-7C</b>   | Clear • Open Grommet • Double Contact Pigtail                            |
| <b>KTL4001-7C</b>   | Clear • Closed Grommet • Double Contact Pigtail                          |
| <b>KTLM4001-7C</b>  | Clear • Closed Grommet • Double Contact Pigtail • Steel Mounting Bracket |

# 4" ROUND LED LAMPS

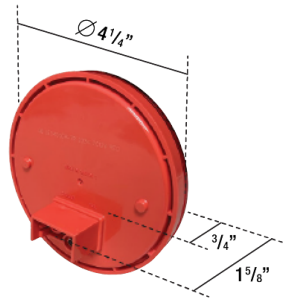

## 7 Diodes (Heated) Series

Sealed Acrylic Lens & ABS Base • 12V

| Part No.           | Colour | Function       | SAE     | Amp Draw |
|--------------------|--------|----------------|---------|----------|
| <b>LED4000H-7A</b> | Amber  | Signal         | I6      | 0.8      |
| <b>LED4000H-7R</b> | Red    | Stop/Turn/Tail | S27I63T | 0.3/0.8  |
| <b>LED4000H-7C</b> | Clear  | Back Up        | 2R      | 0.4      |

For Retail Bag, add the suffix 'P' to the end of the Part No.

|                          |                                |
|--------------------------|--------------------------------|
| <b>Grommets</b>          | GR4000, GR4001                 |
| <b>Pigtails</b>          | PT9530, PT9532, PT9180, PT9182 |
| <b>Mounting Brackets</b> | MB4000                         |
| <b>Decorative Bezels</b> | BZ4000, BZ4000V                |



| SIGNAL / PARK KITS   |  |
|----------------------|--|
| <b>LEDF4000H-7A1</b> | Amber • Black ABS Flange   |
| <b>LEDF4000H-7A2</b> | Amber • Gray ABS Flange  |
| <b>LED4040H-7A</b>   | Amber • Stainless Steel Flange   |
| <b>KTL4000H-7A</b>   | Amber • Open Grommet • Double Contact Pigtail                            |
| <b>KTL4001H-7A</b>   | Amber • Closed Grommet • Double Contact Pigtail                          |
| <b>KTLM4001H-7A</b>  | Amber • Closed Grommet • Double Contact Pigtail • Steel Mounting Bracket |

| STOP / TURN / TAIL KITS |  |
|-------------------------|--|
| <b>LEDF4000H-7R1</b>    | Red • Black ABS Flange   |
| <b>LEDF4000H-7R2</b>    | Red • Gray ABS Flange  |
| <b>LED4040H-7R</b>      | Red • Stainless Steel Flange   |
| <b>KTL4000H-7R</b>      | Red • Open Grommet • Double Contact Pigtail                            |
| <b>KTL4001H-7R</b>      | Red • Closed Grommet • Double Contact Pigtail                          |
| <b>KTLM4001H-7R</b>     | Red • Closed Grommet • Double Contact Pigtail • Steel Mounting Bracket |

| BACK UP KITS         |  |
|----------------------|--|
| <b>LEDF4000H-7C1</b> | Clear • Black ABS Flange   |
| <b>LEDF4000H-7C2</b> | Clear • Gray ABS Flange  |
| <b>LED4040H-7C</b>   | Clear • Stainless Steel Flange   |
| <b>KTL4000H-7C</b>   | Clear • Open Grommet • Double Contact Pigtail                            |
| <b>KTL4001H-7C</b>   | Clear • Closed Grommet • Double Contact Pigtail                          |
| <b>KTLM4001H-7C</b>  | Clear • Closed Grommet • Double Contact Pigtail • Steel Mounting Bracket |

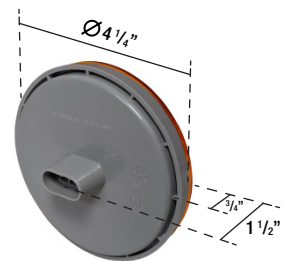

## 10 Diodes (3-Pin) Series

Sealed Acrylic Lens & ABS Base • 12V

| Part No.            | Colour | Function       | SAE    | Amp Draw  |
|---------------------|--------|----------------|--------|-----------|
| <b>LED4000G-10A</b> | Amber  | Signal/Park    | I6P    | 0.02/0.21 |
| <b>LED4000G-10R</b> | Red    | Stop/Turn/Tail | S2T2I6 | 0.02/0.11 |
| <b>LED4000G-10C</b> | Clear  | Back Up        | 2R     | 0.07      |

For Retail Bag, add the suffix 'P' to the end of the Part No.

|                          |                 |
|--------------------------|-----------------|
| <b>Grommets</b>          | GR4000, GR4001  |
| <b>Pigtails</b>          | PT9181-1        |
| <b>Mounting Brackets</b> | MB4000          |
| <b>Decorative Bezels</b> | BZ4000, BZ4000V |



| SIGNAL / PARK KITS    |  |
|-----------------------|--|
| <b>LEDF4000G-10A1</b> | Amber • Black ABS Flange   |
| <b>LEDF4000G-10A2</b> | Amber • Gray ABS Flange  |
| <b>LED4040G-10A</b>   | Amber • Stainless Steel Flange   |
| <b>KTL4000G-10A</b>   | Amber • Open Grommet • Weatherproof Pigtail                            |
| <b>KTL4001G-10A</b>   | Amber • Closed Grommet • Weatherproof Pigtail                          |
| <b>KTLM4001G-10A</b>  | Amber • Closed Grommet • Weatherproof Pigtail • Steel Mounting Bracket |

| STOP / TURN / TAIL KITS |  |
|-------------------------|--|
| <b>LEDF4000G-10R1</b>   | Red • Black ABS Flange   |
| <b>LEDF4000G-10R2</b>   | Red • Gray ABS Flange  |
| <b>LED4040G-10R</b>     | Red • Stainless Steel Flange   |
| <b>KTL4000G-10R</b>     | Red • Open Grommet • Weatherproof Pigtail                            |
| <b>KTL4001G-10R</b>     | Red • Closed Grommet • Weatherproof Pigtail                          |
| <b>KTLM4001G-10R</b>    | Red • Closed Grommet • Weatherproof Pigtail • Steel Mounting Bracket |

| BACK UP KITS          |  |
|-----------------------|--|
| <b>LEDF4000G-10C1</b> | Clear • Black ABS Flange   |
| <b>LEDF4000G-10C2</b> | Clear • Gray ABS Flange  |
| <b>LED4040G-10C</b>   | Clear • Stainless Steel Flange   |
| <b>KTL4000G-10C</b>   | Clear • Open Grommet • Weatherproof Pigtail                            |
| <b>KTL4001G-10C</b>   | Clear • Closed Grommet • Weatherproof Pigtail                          |
| <b>KTLM4001G-10C</b>  | Clear • Closed Grommet • Weatherproof Pigtail • Steel Mounting Bracket |

# 4" ROUND LED LAMPS

STOP / TURN / TAIL / BACK UP LAMPS  
FEUX DE CHANGEMENT DE DIRECTION / ARRÊT / ARRIÈRE / RECUL

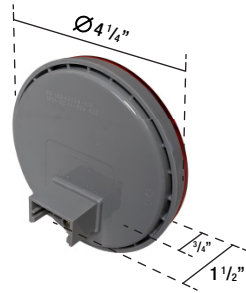

## 10 Diode (Multi-Voltage) Series

Sealed Acrylic Lens & ABS Base

**MULTI-VOLTAGE**  
**12V - 24V**

| Part No.            | Colour | Function       | SAE    | Amp Draw  |
|---------------------|--------|----------------|--------|-----------|
| <b>LED4000M-10R</b> | Red    | Stop/Turn/Tail | S2T216 | 0.02/0.11 |

For Retail Bag, add the suffix 'P' to the end of the Part No.

|                          |                                |
|--------------------------|--------------------------------|
| <b>Grommets</b>          | GR4000, GR4001                 |
| <b>Pigtails</b>          | PT9530, PT9532, PT9180, PT9182 |
| <b>Mounting Brackets</b> | MB4000                         |
| <b>Decorative Bezels</b> | BZ4000, BZ4000V                |

| STOP / TURN / TAIL / PARK KITS |  |
|--------------------------------|--|
| <b>LEDF4000M-10R1</b>          | Red • Black ABS Flange   |
| <b>LEDF4000M-10R2</b>          | Red • Gray ABS Flange  |
| <b>LED4040M-10R</b>            | Red • Stainless Steel Flange   |
| <b>KTL4000M-10R</b>            | Red • Open Grommet • Double Contact Pigtail                            |
| <b>KTL4001M-10R</b>            | Red • Closed Grommet • Double Contact Pigtail                          |
| <b>KTLM4001M-10R</b>           | Red • Closed Grommet • Double Contact Pigtail • Steel Mounting Bracket |



## 10 Diodes (S) Series

Sealed Acrylic Lens & ABS Base • 12V

| Part No.            | Colour | Function            | SAE       | Amp Draw  |
|---------------------|--------|---------------------|-----------|-----------|
| <b>LED4000S-10A</b> | Amber  | Signal/Park         | 16PP2     | 0.01/0.22 |
| <b>LED4000S-10R</b> | Red    | Stop/Turn/Tail/Park | S2T216 P2 | 0.01/0.21 |

### CLEAR LENS LAMPS

|                      |       |                     |           |           |
|----------------------|-------|---------------------|-----------|-----------|
| <b>LED4000CS-10A</b> | Amber | Signal/Park         | 16PP2     | 0.01/0.22 |
| <b>LED4000CS-10R</b> | Red   | Stop/Turn/Tail/Park | S2T216 P2 | 0.01/0.21 |

For Retail Bag, add the suffix 'P' to the end of the Part No.

|                          |                                |
|--------------------------|--------------------------------|
| <b>Grommets</b>          | GR4000, GR4001                 |
| <b>Pigtails</b>          | PT9530, PT9532, PT9180, PT9182 |
| <b>Mounting Brackets</b> | MB4000                         |
| <b>Decorative Bezels</b> | BZ4000, BZ4000V                |

| SIGNAL / PARK KITS    |  |
|-----------------------|--|
| <b>LEDF4000S-10A1</b> | Amber • Black ABS Flange   |
| <b>LEDF4000S-10A2</b> | Amber • Gray ABS Flange  |
| <b>LED4040S-10A</b>   | Amber • Stainless Steel Flange   |
| <b>KTL4000S-10A</b>   | Amber • Open Grommet • Double Contact Pigtail                            |
| <b>KTL4000S-10A</b>   | Amber • Closed Grommet • Double Contact Pigtail                          |
| <b>KTLM4000S-10A</b>  | Amber • Closed Grommet • Double Contact Pigtail • Steel Mounting Bracket |

| STOP / TURN / TAIL / PARK KITS |  |
|--------------------------------|--|
| <b>LEDF4000S-10R1</b>          | Red • Black ABS Flange   |
| <b>LEDF4000S-10R2</b>          | Red • Gray ABS Flange  |
| <b>LED4040S-10R</b>            | Red • Stainless Steel Flange   |
| <b>KTL4000S-10R</b>            | Red • Open Grommet • Double Contact Pigtail                            |
| <b>KTL4000S-10R</b>            | Red • Closed Grommet • Double Contact Pigtail                          |
| <b>KTLM4000S-10R</b>           | Red • Closed Grommet • Double Contact Pigtail • Steel Mounting Bracket |

| SIGNAL / PARK KITS - CLEAR LENS |  |
|---------------------------------|--|
| <b>LEDF4000CS-10A1</b>          | Amber • Black ABS Flange   |
| <b>LEDF4000CS-10A2</b>          | Amber • Gray ABS Flange  |
| <b>LED4040CS-10A</b>            | Amber • Stainless Steel Flange   |
| <b>KTL4000CS-10A</b>            | Amber • Open Grommet • Double Contact Pigtail                            |
| <b>KTL4000CS-10A</b>            | Amber • Closed Grommet • Double Contact Pigtail                          |
| <b>KTLM4000CS-10A</b>           | Amber • Closed Grommet • Double Contact Pigtail • Steel Mounting Bracket |

| STOP / TURN / TAIL / PARK KITS - CLEAR LENS |  |
|---|--|
| <b>LEDF4000CS-10R1</b>                      | Red • Black ABS Flange   |
| <b>LEDF4000CS-10R2</b>                      | Red • Gray ABS Flange  |
| <b>LED4040CS-10R</b>                        | Red • Stainless Steel Flange   |
| <b>KTL4000CS-10R</b>                        | Red • Open Grommet • Double Contact Pigtail                            |
| <b>KTL4000CS-10R</b>                        | Red • Closed Grommet • Double Contact Pigtail                          |
| <b>KTLM4000CS-10R</b>                       | Red • Closed Grommet • Double Contact Pigtail • Steel Mounting Bracket |



# 4" ROUND LED LAMPS

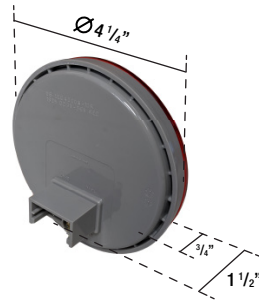

## 10 Diodes Series

Sealed Polycarbonate Lens & ABS Base • 12V

| Part No.           | Colour | Function       | SAE    | Amp Draw  |
|--------------------|--------|----------------|--------|-----------|
| <b>LED4000-10A</b> | Amber  | Signal/Park    | I6P    | 0.03/0.21 |
| <b>LED4000-10R</b> | Red    | Stop/Turn/Tail | S2T2I6 | 0.02/0.11 |
| <b>LED4000-10C</b> | Clear  | Back Up        | 2R     | 0.17      |

### CLEAR LENS LAMPS

|                     |       |                |        |           |
|---------------------|-------|----------------|--------|-----------|
| <b>LED4000C-10A</b> | Amber | Signal/Park    | I6P    | 0.03/0.20 |
| <b>LED4000C-10R</b> | Red   | Stop/Turn/Tail | S2T2I6 | 0.01/0.09 |

For Retail Bag, add the suffix 'P' to the end of the Part No.

|                          |                                |
|--------------------------|--------------------------------|
| <b>Grommets</b>          | GR4000, GR4001                 |
| <b>Pigtails</b>          | PT9530, PT9532, PT9180, PT9182 |
| <b>Mounting Brackets</b> | MB4000                         |
| <b>Decorative Bezels</b> | BZ4000, BZ4000V                |



| SIGNAL / PARK KITS   |  |
|----------------------|--|
| <b>LEDF4000-10A1</b> | Amber • Black ABS Flange   |
| <b>LEDF4000-10A2</b> | Amber • Gray ABS Flange  |
| <b>LEDF4040-10A</b>  | Amber • Stainless Steel Flange   |
| <b>KTL4000-10A</b>   | Amber • Open Grommet • Double Contact Pigtail                            |
| <b>KTL4000-10A</b>   | Amber • Closed Grommet • Double Contact Pigtail                          |
| <b>KTLM4000-10A</b>  | Amber • Closed Grommet • Double Contact Pigtail • Steel Mounting Bracket |

| STOP / TURN / TAIL KITS |  |
|-------------------------|--|
| <b>LEDF4000-10R1</b>    | Red • Black ABS Flange   |
| <b>LEDF4000-10R2</b>    | Red • Gray ABS Flange  |
| <b>LEDF4040-10R</b>     | Red • Stainless Steel Flange   |
| <b>KTL4000-10R</b>      | Red • Open Grommet • Double Contact Pigtail                            |
| <b>KTL4000-10R</b>      | Red • Closed Grommet • Double Contact Pigtail                          |
| <b>KTLM4000-10R</b>     | Red • Closed Grommet • Double Contact Pigtail • Steel Mounting Bracket |

| BACK UP KITS         |  |
|----------------------|--|
| <b>LEDF4000-10C1</b> | Clear • Black ABS Flange   |
| <b>LEDF4000-10C2</b> | Clear • Gray ABS Flange  |
| <b>LEDF4040-10C</b>  | Clear • Stainless Steel Flange   |
| <b>KTL4000-10C</b>   | Clear • Open Grommet • Double Contact Pigtail                            |
| <b>KTL4000-10C</b>   | Clear • Closed Grommet • Double Contact Pigtail                          |
| <b>KTLM4000-10C</b>  | Clear • Closed Grommet • Double Contact Pigtail • Steel Mounting Bracket |

| SIGNAL / PARK KITS - CLEAR LENS |  |
|---------------------------------|--|
| <b>LEDF4000C-10A1</b>           | Amber • Black ABS Flange   |
| <b>LEDF4000C-10A2</b>           | Amber • Gray ABS Flange  |
| <b>LEDF4040C-10A</b>            | Amber • Stainless Steel Flange   |
| <b>KTL4000C-10A</b>             | Amber • Open Grommet • Double Contact Pigtail                            |
| <b>KTL4000C-10A</b>             | Amber • Closed Grommet • Double Contact Pigtail                          |
| <b>KTLM4000C-10A</b>            | Amber • Closed Grommet • Double Contact Pigtail • Steel Mounting Bracket |

| STOP / TURN / TAIL KITS - CLEAR LENS |  |
|--------------------------------------|--|
| <b>LEDF4000C-10R1</b>                | Red • Black ABS Flange   |
| <b>LEDF4000C-10R2</b>                | Red • Gray ABS Flange  |
| <b>LEDF4040C-10R</b>                 | Red • Stainless Steel Flange   |
| <b>KTL4000C-10R</b>                  | Red • Open Grommet • Double Contact Pigtail                            |
| <b>KTL4000C-10R</b>                  | Red • Closed Grommet • Double Contact Pigtail                          |
| <b>KTLM4000C-10R</b>                 | Red • Closed Grommet • Double Contact Pigtail • Steel Mounting Bracket |



# 4" ROUND LED LAMPS

STOP / TURN / TAIL / BACK UP LAMPS  
FEUX DE CHANGEMENT DE DIRECTION / ARRÊT / ARRIÈRE / RECUL



## 12 Diodes Series

Sealed Polycarbonate Lens & Base • 12V

| Part No.            | Colour | Function       | SAE | Amp Draw  |
|---------------------|--------|----------------|-----|-----------|
| <b>LED4000T-12R</b> | Red    | Stop/Turn/Tail | STI | 0.01/0.13 |

For Retail Bag, add the suffix 'P' to the end of the Part No.

|                          |                                |
|--------------------------|--------------------------------|
| <b>Grommets</b>          | GR4000, GR4001                 |
| <b>Pigtails</b>          | PT9530, PT9532, PT9180, PT9182 |
| <b>Mounting Brackets</b> | MB4000                         |
| <b>Decorative Bezels</b> | BZ4000, BZ4000V                |

| STOP / TURN / TAIL KITS |  |
|-------------------------|--|
| <b>LEDF4000-12RO</b>    | Red • White ABS Flange   |
| <b>LEDF4000-12R1</b>    | Red • Black ABS Flange   |
| <b>LEDF4000-12R2</b>    | Red • Gray ABS Flange  |
| <b>KTL4000-12R</b>      | Red • Open Grommet • Double Contact Pigtail                            |
| <b>KTL4001-12R</b>      | Red • Closed Grommet • Double Contact Pigtail                          |
| <b>KTLM4001-12R</b>     | Red • Closed Grommet • Double Contact Pigtail • Steel Mounting Bracket |



Use with PT9181-4 for weather proof connection



## 13 Diodes (4-Pin) Series

LED: 9 Stop/Turn/Tail + 4 Back Up  
Sealed Acrylic Lens & ABS Base • 12V

| Part No.             | Colour       | Function                   | SAE     | Amp Draw  |
|----------------------|--------------|----------------------------|---------|-----------|
| <b>LED4000G-13RW</b> | Red<br>White | Stop/Turn/Tail/<br>Back Up | STI(2)R | 0.03/0.33 |

For Retail Bag, add the suffix 'P' to the end of the Part No.

|                          |                 |
|--------------------------|-----------------|
| <b>Grommets</b>          | GR4000, GR4001  |
| <b>Pigtails</b>          | PT9181-4        |
| <b>Mounting Brackets</b> | MB4000          |
| <b>Decorative Bezels</b> | BZ4000, BZ4000V |

| STOP / TURN / TAIL / BACK UP KITS |  |
|-----------------------------------|--|
| <b>LEDF4000G-13RW1</b>            | Red • Black ABS Flange   |
| <b>LEDF4000G-13RW2</b>            | Red • Gray ABS Flange  |
| <b>LED4040G-13RW</b>              | Red • Stainless Steel Flange   |
| <b>KTL4000G-13RW</b>              | Red • Open Grommet • Weatherproof Pigtail                            |
| <b>KTL4001G-13RW</b>              | Red • Closed Grommet • Weatherproof Pigtail                          |
| <b>KTLM4001G-13RW</b>             | Red • Closed Grommet • Weatherproof Pigtail • Steel Mounting Bracket |



# 4" ROUND LED LAMPS

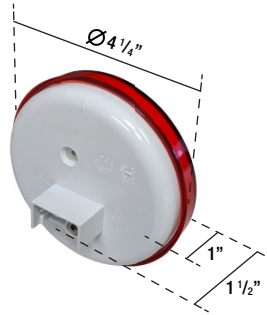

## 24 Diodes Series

Sealed Polycarbonate Lens & ABS Base • 12V

| Part No.           | Colour | Function       | SAE | Amp Draw  |
|--------------------|--------|----------------|-----|-----------|
| <b>LED4000-24A</b> | Amber  | Signal/Park    | IP  | 0.01/0.16 |
| <b>LED4000-24R</b> | Red    | Stop/Turn/Tail | STI | 0.01/0.2  |
| <b>LED4000-24C</b> | Clear  | Back Up        | 2R  | 0.17      |

### CLEAR LENS LAMPS

|                     |       |                |     |           |
|---------------------|-------|----------------|-----|-----------|
| <b>LED4000C-24A</b> | Amber | Signal/Park    | IP  | 0.01/0.16 |
| <b>LED4000C-24R</b> | Red   | Stop/Turn/Tail | STI | 0.01/0.2  |

For Retail Bag, add the suffix 'P' to the end of the Part No.

|                          |                                |
|--------------------------|--------------------------------|
| <b>Grommets</b>          | GR4000, GR4001                 |
| <b>Pigtails</b>          | PT9530, PT9532, PT9180, PT9182 |
| <b>Mounting Brackets</b> | MB4000                         |
| <b>Decorative Bezels</b> | BZ4000, BZ4000V                |



| SIGNAL / PARK KITS   |  |
|----------------------|--|
| <b>LEDF4000-24A1</b> | Amber • Black ABS Flange   |
| <b>LEDF4000-24A2</b> | Amber • Gray ABS Flange  |
| <b>LEDF4040-24A</b>  | Amber • Stainless Steel Flange   |
| <b>KTL4000-24A</b>   | Amber • Open Grommet • Double Contact Pigtail                            |
| <b>KTL4000-24A</b>   | Amber • Closed Grommet • Double Contact Pigtail                          |
| <b>KTLM4000-24A</b>  | Amber • Closed Grommet • Double Contact Pigtail • Steel Mounting Bracket |

| STOP / TURN / TAIL KITS |  |
|-------------------------|--|
| <b>LEDF4000-24R1</b>    | Red • Black ABS Flange   |
| <b>LEDF4000-24R2</b>    | Red • Gray ABS Flange  |
| <b>LEDF4040-24R</b>     | Red • Stainless Steel Flange   |
| <b>KTL4000-24R</b>      | Red • Open Grommet • Double Contact Pigtail                            |
| <b>KTL4000-24R</b>      | Red • Closed Grommet • Double Contact Pigtail                          |
| <b>KTLM4000-24R</b>     | Red • Closed Grommet • Double Contact Pigtail • Steel Mounting Bracket |

| BACK UP KITS         |  |
|----------------------|--|
| <b>LEDF4000-24C1</b> | Clear • Black ABS Flange   |
| <b>LEDF4000-24C2</b> | Clear • Gray ABS Flange  |
| <b>LEDF4040-24C</b>  | Clear • Stainless Steel Flange   |
| <b>KTL4000-24C</b>   | Clear • Open Grommet • Double Contact Pigtail                            |
| <b>KTL4000-24C</b>   | Clear • Closed Grommet • Double Contact Pigtail                          |
| <b>KTLM4000-24C</b>  | Clear • Closed Grommet • Double Contact Pigtail • Steel Mounting Bracket |

| SIGNAL / PARK KITS - CLEAR LENS |  |
|---------------------------------|--|
| <b>LEDF4000C-24A1</b>           | Amber • Black ABS Flange   |
| <b>LEDF4000C-24A2</b>           | Amber • Gray ABS Flange  |
| <b>LEDF4040C-24A</b>            | Amber • Stainless Steel Flange   |
| <b>KTL4000C-24A</b>             | Amber • Open Grommet • Double Contact Pigtail                            |
| <b>KTL4000C-24A</b>             | Amber • Closed Grommet • Double Contact Pigtail                          |
| <b>KTLM4000C-4A</b>             | Amber • Closed Grommet • Double Contact Pigtail • Steel Mounting Bracket |

| STOP / TURN / TAIL KITS - CLEAR LENS |  |
|--------------------------------------|--|
| <b>LEDF4000C-24R1</b>                | Red • Black ABS Flange   |
| <b>LEDF4000C-24R2</b>                | Red • Gray ABS Flange  |
| <b>LEDF4040C-24R</b>                 | Red • Stainless Steel Flange   |
| <b>KTL4000C-24R</b>                  | Red • Open Grommet • Double Contact Pigtail                            |
| <b>KTL4000C-24R</b>                  | Red • Closed Grommet • Double Contact Pigtail                          |
| <b>KTLM4000C-24R</b>                 | Red • Closed Grommet • Double Contact Pigtail • Steel Mounting Bracket |

# 4" SPECIALTY ROUND LAMPS

STOP / TURN / TAIL / BACK UP LAMPS  
FEUX DE CHANGEMENT DE DIRECTION / ARRÊT / ARRIÈRE / RECUL

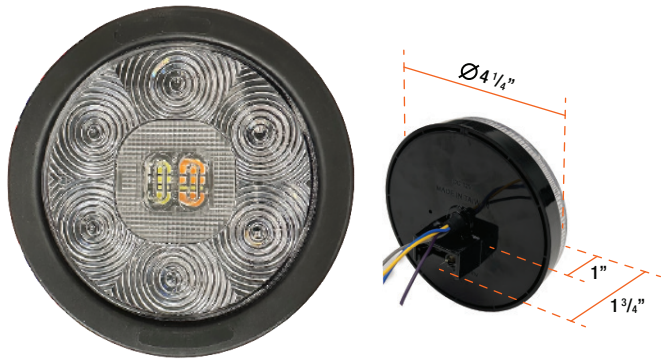

## 21 Diodes (Combo) LED Series

5 Flash Patterns • IP67  
Sealed Acrylic Lens & ABS Base • 12V

| Part No.             | Colour         | Function                                      | SAE                      | Amp Draw |
|----------------------|----------------|---|--------------------------|----------|
| <b>LED2238E-21AW</b> | Amber<br>White | Stop/Turn/Tail/<br>Back Up<br>+ Warning Light | S2T2I6R<br>SAE<br>Class1 | 0.8      |

For Retail Bag, add the suffix 'P' to the end of the Part No.

|                          |                                |
|--------------------------|--------------------------------|
| <b>Grommets</b>          | GR2238, GR2239                 |
| <b>Pigtails</b>          | PT9530, PT9532, PT9180, PT9182 |
| <b>Mounting Brackets</b> | MB2238                         |

| STOP / TURN / TAIL / PARK KITS |   |
|--------------------------------|---|
| <b>KTL4000E-21AW</b>           | Lamp • Open Grommet • Double Contact Pigtail                            |
| <b>KTL4001E-21AW</b>           | Lamp • Closed Grommet • Double Contact Pigtail                          |
| <b>KTLM4001E-21AW</b>          | Lamp • Closed Grommet • Double Contact Pigtail • Steel Mounting Bracket |

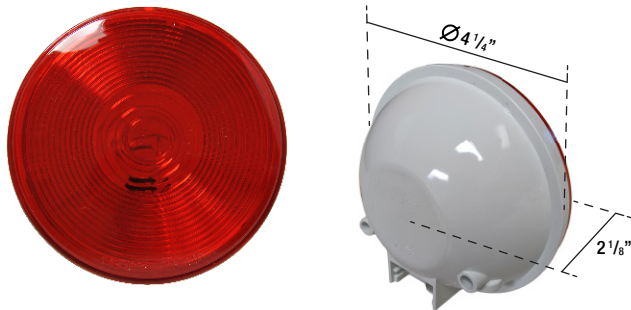

## Incandescent Series

Sealed Polycarbonate Lens & Base • 12V

| Part No.       | Colour | Function            | SAE  | Amp Draw  |
|----------------|--------|---------------------|------|-----------|
| <b>SE4000A</b> | Amber  | Signal/Park         | IP   | 0.48/2.10 |
| <b>SE4000R</b> | Red    | Stop/Turn/Tail/Park | STIP | 0.48/2.10 |
| <b>SE4000W</b> | Clear  | Back Up             | 2R   | 0.48      |

### CLEAR LENS LAMPS

|                |     |                                   |      |           |
|----------------|-----|-----------------------------------|------|-----------|
| <b>SR4000R</b> | Red | Stop/Turn/Tail/<br>Rear Reflector | STIA | 0.48/2.10 |
|----------------|-----|-----------------------------------|------|-----------|

For Retail Bag, add the suffix 'P' to the end of the Part No.

|                          |                                |
|--------------------------|--------------------------------|
| <b>Grommets</b>          | GR2238, GR2239                 |
| <b>Pigtails</b>          | PT9530, PT9532, PT9180, PT9182 |
| <b>Mounting Brackets</b> | MB2238                         |
| <b>Decorative Bezels</b> | BZ2238, BZ2238V                |

| SIGNAL / PARK KITS |  |
|--------------------|--|
| <b>SEF4000A-1</b>  | Amber • Black ABS Flange   |
| <b>SEF4000A-2</b>  | Amber • Gray ABS Flange  |
| <b>SE4040ASS</b>   | Amber • Stainless Steel Flange   |
| <b>KT3405A</b>     | Amber • Open Grommet • Double Contact Pigtail                            |
| <b>KT3415A</b>     | Amber • Closed Grommet • Double Contact Pigtail                          |
| <b>KTM4001A</b>    | Amber • Closed Grommet • Double Contact Pigtail • Steel Mounting Bracket |

| STOP / TURN / TAIL / PARK KITS |  |
|--------------------------------|--|
| <b>SEF4000R-1</b>              | Red • Black ABS Flange   |
| <b>SEF4000R-2</b>              | Red • Gray ABS Flange  |
| <b>SE4040RSS</b>               | Red • Stainless Steel Flange   |
| <b>KT3405R</b>                 | Red • Open Grommet • Double Contact Pigtail                            |
| <b>KT3415R</b>                 | Red • Closed Grommet • Double Contact Pigtail                          |
| <b>KTM4001R</b>                | Red • Closed Grommet • Double Contact Pigtail • Steel Mounting Bracket |

| BACK UP KITS      |  |
|-------------------|--|
| <b>SEF4000W-1</b> | White • Black ABS Flange   |
| <b>SEF4000W-2</b> | White • Gray ABS Flange  |
| <b>SE4040WSS</b>  | White • Stainless Steel Flange   |
| <b>KT3405W</b>    | White • Open Grommet • Double Contact Pigtail                            |
| <b>KT3415W</b>    | White • Closed Grommet • Double Contact Pigtail                          |
| <b>KTM4001W</b>   | White • Closed Grommet • Double Contact Pigtail • Steel Mounting Bracket |

| STOP / TURN / TAIL KITS - RED REFLECTOR |  |
|---|--|
| <b>SRF4000R-1</b>                       | Red • Black ABS Flange   |
| <b>SRF4000R-2</b>                       | Red • Gray ABS Flange  |
| <b>SR4040RSS</b>                        | Red • Stainless Steel Flange   |
| <b>KTR5400R</b>                         | Red • Open Grommet • Double Contact Pigtail                            |
| <b>KTR5401R</b>                         | Red • Closed Grommet • Double Contact Pigtail                          |
| <b>KTMR5401R</b>                        | Red • Closed Grommet • Double Contact Pigtail • Steel Mounting Bracket |

# 6" x 4" RECTANGULAR LED LAMPS

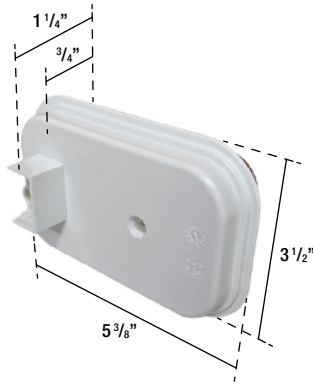

## 24 Diodes Series

Sealed Acrylic Lens & Polycarbonate Base • 12V

| Part No.           | Colour | Function            | SAE            | Amp Draw  |
|--------------------|--------|---------------------|----------------|-----------|
| <b>LED4060-24A</b> | Amber  | Signal/Park         | I6PP2          | 0.03/0.18 |
| <b>LED4060-24R</b> | Red    | Stop/Turn/Tail/Park | I6P2<br>S2(3)T | 0.02/0.11 |

| SIGNAL / PARK KITS  |   |
|---------------------|---|
| <b>KTL4060-24A</b>  | Amber • Open Grommet • Double Contact Pigtail                               |
| <b>KTLM4060-24A</b> | Amber • Closed Grommet • Double Contact Pigtail<br>• Steel Mounting Bracket |

For Retail Bag, add the suffix 'P' to the end of the Part No.

|                          |                                |
|--------------------------|--------------------------------|
| <b>Grommets</b>          | GR4060                         |
| <b>Pigtails</b>          | PT9530, PT9532, PT9180, PT9182 |
| <b>Mounting Brackets</b> | MB4060                         |

| STOP / TURN / TAIL / PARK KITS |   |
|--------------------------------|---|
| <b>KTL4060-24R</b>             | Red • Open Grommet • Double Contact Pigtail                               |
| <b>KTLM4060-24R</b>            | Red • Closed Grommet • Double Contact Pigtail •<br>Steel Mounting Bracket |

# 7" x 6" COMBINATION LAMPS

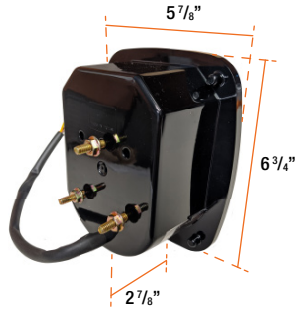

## LED Series

Sealed Acrylic Lens & ABS Base • 12V

| Part No.       | Diodes                             | Function  | SAE              | Amp Draw  |
|----------------|------------------------------------|---|------------------|-----------|
| <b>LTL6400</b> | 16 Tail<br>18 Back Up<br>3 License | Stop/Turn/Tail/<br>Rear Reflector/<br>License/Back Up | AI6L2R<br>S2(3)T | 0.04/0.14 |

For Clamshell, add the suffix '-C' to the end of the Part No.

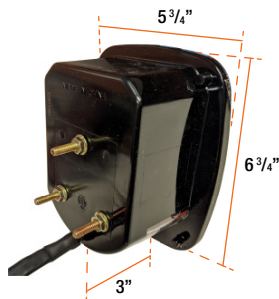

## Incandescent Series

Sealed Acrylic Lens & Polycarbonate Base • 12V

| Part No.      | Bulbs             | Function  | SAE    | Amp Draw  |
|---------------|-------------------|---|--------|-----------|
| <b>TL6400</b> | 1156<br>&<br>1157 | Stop/Turn/Tail/<br>Rear Reflector/<br>License/Back Up | AILRST | 0.59/4.20 |

For Clamshell, add the suffix '-C' to the end of the Part No.

# SLIM LINE LED LIGHT BARS

STOP / TURN / TAIL / BACK UP LAMPS  
FEUX DE CHANGEMENT DE DIRECTION / ARRÊT / ARRIÈRE / RECUL



## 15.5" Stop/Turn/Tail + Back Up Series

LED: 8 Stop/Turn/Tail + 4 Back Up  
Sealed Polycarbonate Lens & Body • 12V

| Part No.             | Colour                  | Function                   | SAE      | Amp Draw |
|----------------------|-------------------------|----------------------------|----------|----------|
| <b>LLB1155S-12RW</b> | Red STT<br>Clear BackUp | Stop/Turn/Tail/<br>Back Up | S2T2(2)R | 0.3      |

For Retail Bag, add the suffix 'P' to the end of the Part No.

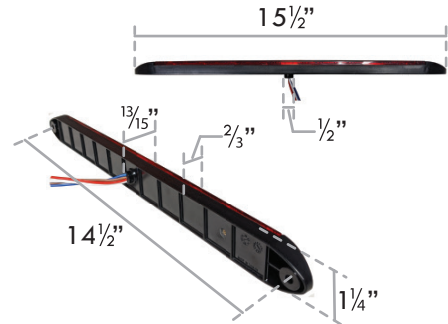

## 15.5" Stop/Turn/Tail Series

LED: 11 Diodes  
Sealed Acrylic Lens & ABS Body • 12V

| Part No.             | Colour                   | Function       | SAE    | Amp Draw |
|----------------------|--------------------------|----------------|--------|----------|
| <b>LLB1015S-11R</b>  | Red Lens<br>Red Diodes   | Stop/Turn/Tail | I6T2S2 | 0.3      |
| <b>LLB1015S-11CR</b> | Clear Lens<br>Red Diodes | Stop/Turn/Tail | I6T2S2 | 0.3      |

For Retail Bag, add the suffix 'P' to the end of the Part No.

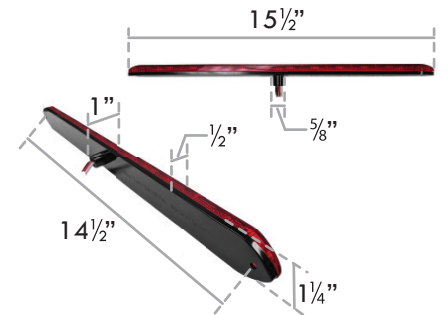

## 16" Stop/Tail + I.D. Auxiliary Signal Series

LED: 13 Diodes  
Sealed Acrylic Lens & ABS Body • 12V

| Part No.            | Colour | Function  | SAE  | Amp Draw  |
|---------------------|--------|---|------|-----------|
| <b>LLB1016S-13R</b> | Red    | Stop/Tail/Identification<br>Auxiliary Turn Signal | P2S2 | 0.19/0.37 |

For Retail Bag, add the suffix 'P' to the end of the Part No.

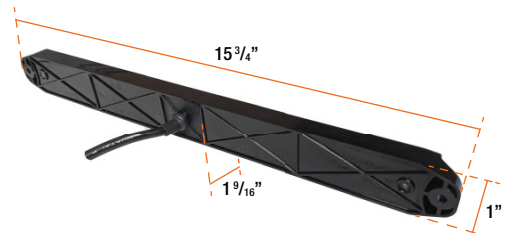



# LED TAILGATE LIGHTS

Sealed lamps are hermetically sealed to keep out road contaminants and moisture. Connections are plated to resist corrosion, internally soldered and compatible with industry pigtails. All lamps are compliant to DOT FMVSS108 standards & MOT CMVSS108 safety standards and are coded accordingly.

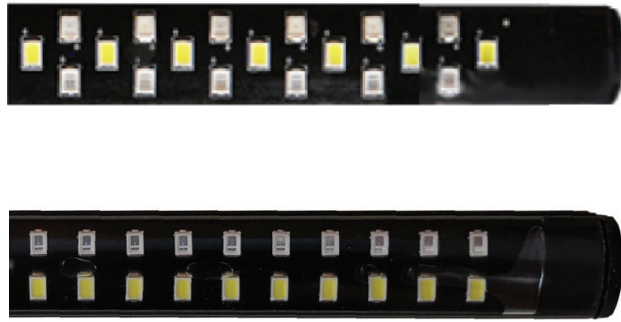

## 60" Tailgate Light

LED: 360 Diodes • 12V  
 Sealed Waterproof Epoxy Encapsulated LED Board  
 3M Tape or Mounting Bracket (included)

| Part No.        | Colour             | Function   | Amp Draw | Pkg  |
|-----------------|--------------------|--|----------|------|
| <b>TG360ARW</b> | Amber, Red & White | Auxiliary Amber Turn Signal<br>Stop/Tail/Back Up | 5 @ 12V  | Tube |
| <b>TG360RW</b>  | Red & White        | Auxiliary Red Turn Signal<br>Stop/Tail/Back Up   | 5 @ 12V  | Tube |

Outside Controller

4-Way Flat Connector  
 +wire for backup light

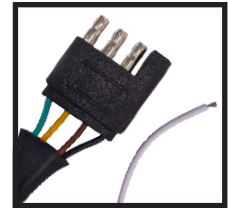
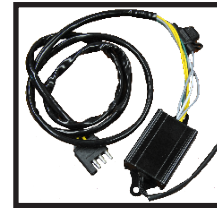

# 7" LED ROUND LAMPS

Lamps come with lead wires for surface mount installation without pigtailed. Built-in circuit breaker prevents lamps being damaged by voltage spikes. Lamps cease to light when voltage spikes up to 36V and will restart automatically when voltage drops.

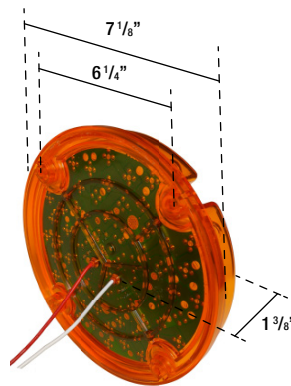

## 47 Diodes Series

Sealed Acrylic Lens & ABS Base • 12V

| Part No.        | Colour | Function                              | SAE             | Amp Draw  | Pkg  |
|-----------------|--------|---------------------------------------|-----------------|-----------|------|
| <b>LED7010A</b> | Amber  | Turn Signal/<br>Rear Reflector        | A16             | 0.19      | Bulk |
| <b>LED7010R</b> | Red    | Stop/Turn/Tail/Park<br>Rear Reflector | Al6P2<br>S2(3)T | 0.01/0.32 | Bulk |



# TRAILER LAMPS FOR VEHICLES UNDER 80"

TRAILER & UTILITY TRAILER LAMPS  
FEUX DE REMORQUE ET REMORQUE UTILITAIRE

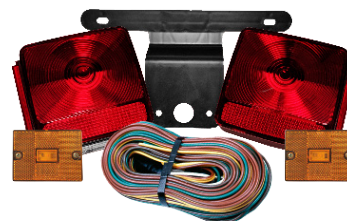

## 5'' x 4.5'' Submersible - LED

Sealed Acrylic Lens & ABS Housing

| Part No.        | Diodes                          | Function  | SAE            | Amp Draw  |
|-----------------|---------------------------------|---|----------------|-----------|
| <b>LTL4141</b>  | 1 Tail<br>1 Marker              | Stop/Turn/Tail/<br>Rear & Side Reflector/<br>Marker         | AIST/<br>AP2   | 0.05/0.18 |
| <b>LTL4141L</b> | 1 Tail<br>1 Marker<br>2 License | Stop/Turn/Tail/<br>Rear & Side Reflector/<br>Marker/License | AIST/<br>AP2/L | 0.14/0.18 |

| TRAILER KITS      |   |
|-------------------|---|
| <b>LTL4141K-S</b> | LTL4141 & LTL4141L<br>Led Amber Side Markers<br>License Bracket & Trunk Connector<br>25 ft Wire Harness & Mounting Hardware |

For Retail Bag, add the suffix 'P' to the end of the Part No.



## 5'' x 4.5'' Submersible - LED

Sealed Acrylic Lens & ABS Housing

| Part No.        | Diodes                           | Function  | SAE              | Amp Draw  |
|-----------------|----------------------------------|---|------------------|-----------|
| <b>LTL5451</b>  | 14 Tail<br>1 Marker              | Stop/Turn/Tail/<br>Rear Reflector/<br>Side Marker         | AISTP2/<br>AP2   | 0.08/0.19 |
| <b>LTL5451L</b> | 14 Tail<br>1 Marker<br>2 License | Stop/Turn/Tail/<br>Rear Reflector/<br>Side Marker/License | AISTP2/<br>AP2/L | 0.11/0.22 |

| TRAILER KITS    |   |
|-----------------|---|
| <b>LTL5451K</b> | LTL5451 & LTL5451L<br>License Bracket & Trunk Connector<br>25 ft Wire Harness & Mounting Hardware |

For Retail Bag, add the suffix 'P' to the end of the Part No.

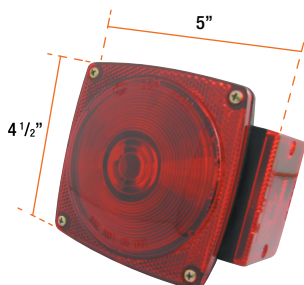

## 5'' x 4.5'' Submersible - Incandescent

Acrylic Lens & Plastic Housing

| Part No.       | Diodes           | Function  | SAE            | Amp Draw  |
|----------------|------------------|---|----------------|-----------|
| <b>TL5441</b>  | 1157<br>&<br>193 | Stop/Turn/Tail/<br>Rear & Side Reflector/<br>Marker         | AIST/<br>AP2   | 0.86/2.37 |
| <b>TL5441L</b> | 1157<br>&<br>193 | Stop/Turn/Tail/<br>Rear & Side Reflector/<br>Marker/License | AIST/<br>AP2/L | 0.86/2.37 |

|                          |                     |
|--------------------------|---------------------|
| <b>Replacement Lens</b>  | TLR5450R, TLR5450RP |
| <b>Replacement Bulbs</b> | HB1157, HB194       |

For Retail Bag, add the suffix 'P' to the end of the Part No.

# TRAILER LAMPS FOR VEHICLES UNDER 80"

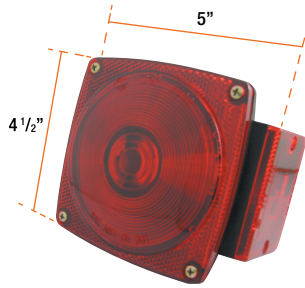

## 5" x 4.5" - Incandescent

Acrylic Lens & Polypropylene Housing

| Part No.       | Diodes           | Function  | SAE            | Amp Draw  |
|----------------|------------------|---|----------------|-----------|
| <b>TL4400</b>  | 1157<br>&<br>193 | Stop/Turn/Tail/<br>Rear & Side Reflector/<br>Marker         | AIST/<br>AP2   | 0.86/2.37 |
| <b>TL4400L</b> | 1157<br>&<br>193 | Stop/Turn/Tail/<br>Rear & Side Reflector/<br>Marker/License | AIST/<br>AP2/L | 0.86/2.37 |

For Retail Bag, add the suffix 'P' to the end of the Part No.

| TRAILER KITS   |  |
|----------------|--|
| <b>TL4400K</b> | TL4400 & TL4400L<br>Incandescent Amber Side Markers<br>License Bracket & Trunk Connector<br>25 ft Wire Harness & Mounting Hardware |

|                          |               |
|--------------------------|---------------|
| <b>Replacement Bulbs</b> | HB1157, HB194 |
|--------------------------|---------------|

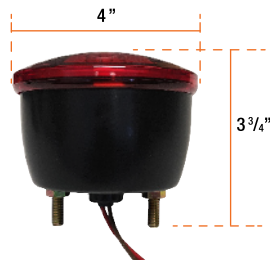

## 4" Round - Incandescent

Acrylic Lens & Polypropylene Housing

| Part No.       | Diodes | Function                   | SAE  | Amp Draw  |
|----------------|--------|----------------------------|------|-----------|
| <b>TL4401</b>  | 1157   | Stop/Turn/Tail/            | STI  | 0.59/2.10 |
| <b>TL4401L</b> | 1157   | Stop/Turn/Tail/<br>License | STIL | 0.59/2.10 |

For Retail Bag, add the suffix 'P' to the end of the Part No.

|                          |                     |
|--------------------------|---------------------|
| <b>Replacement Lens</b>  | TLR4401R, TLR4401RP |
| <b>Replacement Bulbs</b> | HB1157              |

# TRAILER LAMPS FOR VEHICLES OVER 80"

TRAILER & UTILITY TRAILER LAMPS  
FEUX DE REMORQUE ET REMORQUE UTILITAIRE



## 5.5" x 4.5" Submersible - LED

Sealed Acrylic Lens & ABS Housing

| Part No.        | Diodes                          | Function  | SAE              | Amp Draw  |
|-----------------|---------------------------------|---|------------------|-----------|
| <b>LTL4142</b>  | 1 Tail<br>2 Marker              | Stop/Turn/Tail/<br>Rear & Side Reflector/<br>Marker         | AIS2T2/<br>AP2   | 0.05/0.18 |
| <b>LTL4142L</b> | 1 Tail<br>2 Marker<br>2 License | Stop/Turn/Tail/<br>Rear & Side Reflector/<br>Marker/License | AIS2T2/<br>AP2/L | 0.14/0.18 |

| TRAILER KITS    |   |
|-----------------|---|
| <b>LTL4142K</b> | LTL4142 & LTL4142L<br>License Bracket & Trunk Connector<br>25 ft Wire Harness & Mounting Hardware |

For Retail Bag, add the suffix 'P' to the end of the Part No.

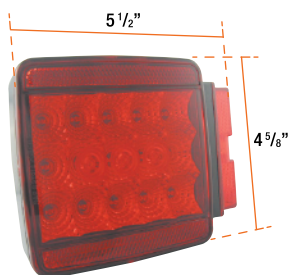

## 5.5" x 4.5" Waterproof - LED

Sealed Acrylic Lens & ABS Housing

| Part No.        | Diodes                           | Function  | SAE              | Amp Draw  |
|-----------------|----------------------------------|---|------------------|-----------|
| <b>LTL5452</b>  | 15 Tail<br>2 Marker              | Stop/Turn/Tail/<br>Rear Reflector/<br>Side Marker         | AISTP2/<br>AP2   | 0.05/0.22 |
| <b>LTL5452L</b> | 15 Tail<br>2 Marker<br>2 License | Stop/Turn/Tail/<br>Rear Reflector/<br>Side Marker/License | AISTP2/<br>AP2/L | 0.09/0.26 |

| TRAILER KITS    |   |
|-----------------|---|
| <b>LTL5452K</b> | LTL5452 & LTL5452L<br>License Bracket & Trunk Connector<br>25 ft Wire Harness & Mounting Hardware |

For Retail Bag, add the suffix 'P' to the end of the Part No.



## 6" x 4.5" Submersible - Incandescent

Acrylic Lens & Plastic Housing

| Part No.        | Diodes           | Function  | SAE            | Amp Draw  |
|-----------------|------------------|---|----------------|-----------|
| <b>TL5450RH</b> | 1157<br>&<br>193 | Stop/Turn/Tail/<br>Rear & Side Reflector/<br>Marker         | AIST/<br>APC   | 0.86/2.37 |
| <b>TL5450LH</b> | 1157<br>&<br>193 | Stop/Turn/Tail/<br>Rear & Side Reflector/<br>Marker/License | AIST/<br>APC/L | 0.86/2.37 |

**Replacement Lens** TLR5450R, TLR5450RP  
**Replacement Bulbs** HB1157, HB194

For Retail Bag, add the suffix 'P' to the end of the Part No.

# TRAILER LAMPS FOR VEHICLES OVER 80"



## 8" x 3" Submersible Low Profile - LED

Acrylic Lens & Polycarbonate Housing

| Part No.        | Diodes                           | Function  | SAE              | Amp Draw  |
|-----------------|----------------------------------|---|------------------|-----------|
| <b>LTL7101</b>  | 15 Tail<br>3 Marker              | Stop/Turn/Tail/<br>Rear & Side Reflector/<br>Marker         | STIAP2/<br>AP2   | 0.07/0.21 |
| <b>LTL7101L</b> | 15 Tail<br>3 Marker<br>2 License | Stop/Turn/Tail/<br>Rear & Side Reflector/<br>Marker/License | STIAP2/<br>AP2/L | 0.09/0.25 |

For Retail Bag, add the suffix 'P' to the end of the Part No.



### TRAILER KITS

|                 |   |
|-----------------|---|
| <b>LTL7101K</b> | LTL7101 & LTL7101L<br>Led Amber Side Markers<br>License Bracket & Trunk Connector<br>20 ft Wire Harness & Mounting Hardware |
|-----------------|---|



## 8" x 3" Waterproof - Incandescent

Acrylic Lens & Plastic Housing

| Part No.       | Bulbs            | Function  | SAE           | Amp Draw  |
|----------------|------------------|---|---------------|-----------|
| <b>TL7000</b>  | 1157<br>&<br>193 | Stop/Turn/Tail/<br>Rear & Side Reflector/<br>Marker         | AIST/PC       | 0.86/2.37 |
| <b>TL7000L</b> | 1157<br>&<br>193 | Stop/Turn/Tail/<br>Rear & Side Reflector/<br>Marker/License | AIST/<br>PC/L | 0.86/2.37 |

For Retail Bag, add the suffix 'P' to the end of the Part No.



# LOW PROFILE CLEARANCE MARKER LAMPS

FENDER MOUNT LAMPS  
FEUX A MONTAGE SUR GABARIT

## 1 Diode Mini Series - Dual Face LED

Sealed Polycarbonate Lens & Plastic Housing

| Part No. | Colour | Function | SAE | Amp Draw |
|----------|--------|----------|-----|----------|
|----------|--------|----------|-----|----------|

### Left Hand (Driver Side) Lamp

|                   |              |                  |      |     |
|-------------------|--------------|------------------|------|-----|
| <b>LFML0720RA</b> | Red<br>Amber | Clearance Marker | P2PC | 0.1 |
|-------------------|--------------|------------------|------|-----|

### Right Hand (Curb Side) Lamp

|                   |              |                  |      |     |
|-------------------|--------------|------------------|------|-----|
| <b>LFMR0720RA</b> | Amber<br>Red | Clearance Marker | P2PC | 0.1 |
|-------------------|--------------|------------------|------|-----|

For Retail Bag, add the suffix 'P' to the end of the Part No.



Height: 1 1/4" Depth  
Wire Length: 12"

Body Mounting Bolt Holes: 2 @ 3.81" centres

Wiring Cover Mounting Bolt Holes: 4 @ 1" by 2.63" centres

## 1 Diode Rectangular Series - Dual Face LED

Sealed Polycarbonate Lens & Plastic Housing

| Part No. | Colour | Function | SAE | Amp Draw |
|----------|--------|----------|-----|----------|
|----------|--------|----------|-----|----------|

### Left Hand (Driver Side) Lamp

|                     |              |                  |    |      |
|---------------------|--------------|------------------|----|------|
| <b>LFML1225-1RA</b> | Red<br>Amber | Clearance Marker | P2 | 0.12 |
|---------------------|--------------|------------------|----|------|

### Right Hand (Curb Side) Lamp

|                     |              |                  |    |      |
|---------------------|--------------|------------------|----|------|
| <b>LFMR1225-1RA</b> | Amber<br>Red | Clearance Marker | P2 | 0.12 |
|---------------------|--------------|------------------|----|------|

For Retail Bag, add the suffix 'P' to the end of the Part No.

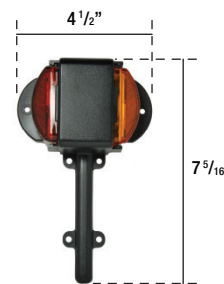

Height: 2 13/16" Depth  
Wire Length: 60"

## 3 Diode Rectangular Series - Dual Face LED

Sealed Polycarbonate Lens & Plastic Housing

| Part No. | Colour | Function | SAE | Amp Draw |
|----------|--------|----------|-----|----------|
|----------|--------|----------|-----|----------|

### Left Hand (Driver Side) Lamp

|                     |              |                  |    |     |
|---------------------|--------------|------------------|----|-----|
| <b>LFML1225-3RA</b> | Red<br>Amber | Clearance Marker | P2 | 0.1 |
|---------------------|--------------|------------------|----|-----|

### Right Hand (Curb Side) Lamp

|                     |              |                  |    |     |
|---------------------|--------------|------------------|----|-----|
| <b>LFMR1225-3RA</b> | Amber<br>Red | Clearance Marker | P2 | 0.1 |
|---------------------|--------------|------------------|----|-----|

For Retail Bag, add the suffix 'P' to the end of the Part No.



## Rectangular Series - Dual Face Incandescent

Sealed Polycarbonate Lens & Plastic Housing

| Part No. | Colour | Function | SAE | Amp Draw |
|----------|--------|----------|-----|----------|
|----------|--------|----------|-----|----------|

### Left Hand (Driver Side) Lamp

|                  |              |                  |    |      |
|------------------|--------------|------------------|----|------|
| <b>FML1225RA</b> | Red<br>Amber | Clearance Marker | P2 | 0.54 |
|------------------|--------------|------------------|----|------|

### Right Hand (Curb Side) Lamp

|                  |              |                  |    |      |
|------------------|--------------|------------------|----|------|
| <b>FMR1225RA</b> | Amber<br>Red | Clearance Marker | P2 | 0.54 |
|------------------|--------------|------------------|----|------|

For Retail Bag, add the suffix 'P' to the end of the Part No.



### REPLACEMENT PARTS FOR 1225 SERIES

|                         |                     |
|-------------------------|---------------------|
| Replacement Brackets    | BM9925, MB9925P     |
| 60" Wire Set w/ 2 Plugs | PT6020-2, PT6020-2P |



# ROUND (STOP / TURN / TAIL) LAMPS

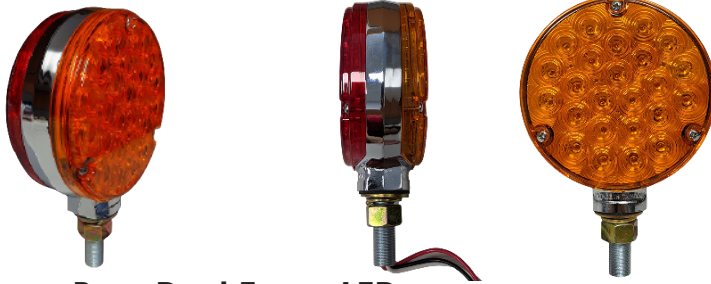

## Chrome Base Dual Face - LED

Polycarbonate Lens & Zinc Housing  
Waterproof

| Part No.            | Colour            | Function         | SAE    | Amp Draw |
|---------------------|-------------------|------------------|--------|----------|
| <b>LFM4102-24RA</b> | 24 Red & 24 Amber | Signal/Park/Tail | S2T16P | 0.04/0.4 |
| <b>LFM4102-24AA</b> | 48 Amber          | Stop/Park        | I6P    | 0.04/0.4 |

### CLEAR LENS LAMPS

|                      |                   |                  |        |          |
|----------------------|-------------------|------------------|--------|----------|
| <b>LFM4102C-24RA</b> | 24 Red & 24 Amber | Signal/Park/Tail | S2T16P | 0.04/0.4 |
| <b>LFM4102C-24AA</b> | 48 Amber          | Stop/Park        | I6P    | 0.04/0.4 |

For Retail Bag, add the suffix 'P' to the end of the Part No.



## Black Base Single Face - Incandescent

Acrylic Lens & ABS Housing  
Bulb: 2057

| Part No.       | Colour | Function            | SAE  | Amp Draw |
|----------------|--------|---------------------|------|----------|
| <b>FM4402A</b> | Amber  | Signal/Park         | IP   | 2.10     |
| <b>FM4402R</b> | Red    | Stop/Turn/Tail/Park | STIP | 2.10     |

For Retail Bag, add the suffix 'P' to the end of the Part No.

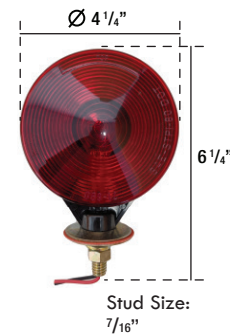

Replacement Amber Lens FMR4402A, FMR4402AP  
Replacement Red Lens FMR4402R, FMR4402RP  
Replacement Bulbs HB1157, HB2057  
Decorative Bezels BZ4000, BZ4000V



## Black Base Dual Face - Incandescent

Acrylic Lens & ABS Housing  
Bulb: 1157

| Part No.        | Colour        | Function            | SAE  | Amp Draw |
|-----------------|---------------|---------------------|------|----------|
| <b>FM4402AA</b> | Amber & Amber | Signal/Park         | IP   | 2.10     |
| <b>FM4402RA</b> | Red & Amber   | Stop/Turn/Tail/Park | STIP | 2.10     |

For Retail Bag, add the suffix 'P' to the end of the Part No.

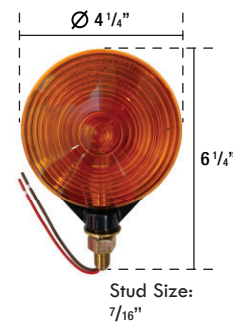

Replacement Amber Lens FMR4402A, FMR4402AP  
Replacement Red Lens FMR4402R, FMR4402RP  
Replacement Bulbs HB1157, HB2057  
Decorative Bezels BZ4000, BZ4000V

# SQUARE (STOP / TURN / TAIL) LAMPS

## Chrome Base Single Stud Dual Face - LED

Polycarbonate Lens & Zinc Housing, 3-Lead Wires  
Waterproof

| Part No.  | Colour                       | Function                          | SAE             | Amp Draw |
|---|------------------------------|-----------------------------------|-----------------|----------|
| <b>Left Hand (Driver Side) Lamp w/ Amber Side Marker (Left)</b> |                              |                                   |                 |          |
| <b>LFML5213RA</b>   | 24 Red<br>24 Amber<br>2 Side | Turn/Tail/Park/<br>Side Reflector | S2T2I6P/<br>AP2 | 0.1/0.4  |

|   |                              |                                   |                 |         |
|---|------------------------------|-----------------------------------|-----------------|---------|
| <b>Right Hand (Curb Side) Lamp w/ Amber Side Marker (Right)</b> |                              |                                   |                 |         |
| <b>LFMR5213RA</b>   | 24 Red<br>24 Amber<br>2 Side | Turn/Tail/Park/<br>Side Reflector | S2T2I6P/<br>AP2 | 0.1/0.4 |

For Retail Bag, add the suffix 'P' to the end of the Part No.

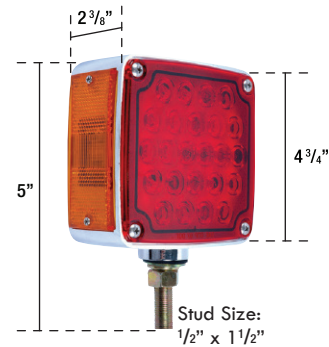

## Chrome Base Two Studs Dual Face - LED

Polycarbonate Lens & Zinc Housing, 3-Lead Wires  
Waterproof

| Part No.  | Colour                         | Function                          | SAE             | Amp Draw |
|---|--------------------------------|-----------------------------------|-----------------|----------|
| <b>Left Hand (Driver Side) Lamp w/ Amber Side Marker (Left)</b> |                                |                                   |                 |          |
| <b>LFML5223RA</b>   | 24 Red<br>24 Amber<br>2 Side   | Turn/Tail/Park/<br>Side Reflector | S2T2I6P/<br>AP2 | 0.1/0.4  |
| <b>LFML5223AA</b>   | 24 Amber<br>24 Amber<br>2 Side | Turn/Side Reflector               | S2T2I6P/<br>AP2 | 0.1/0.4  |

|   |                                |                                   |                 |         |
|---|--------------------------------|-----------------------------------|-----------------|---------|
| <b>Right Hand (Curb Side) Lamp w/ Amber Side Marker (Right)</b> |                                |                                   |                 |         |
| <b>LFMR5223RA</b>   | 24 Amber<br>24 Red<br>2 Side   | Turn/Tail/Park/<br>Side Reflector | S2T2I6P/<br>AP2 | 0.1/0.4 |
| <b>LFMR5223AA</b>   | 24 Amber<br>24 Amber<br>2 Side | Turn/Side Reflector               | S2T2I6P/<br>AP2 | 0.1/0.4 |

For Retail Bag, add the suffix 'P' to the end of the Part No.

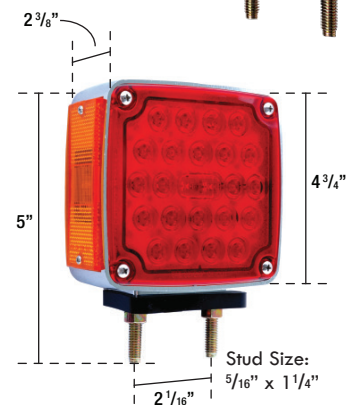

# 3/4" ROUND LED LAMPS

Compact side clearance marker lamp comes with grommet and lead wire. Lead wire is covered with heat shrinkable tube.

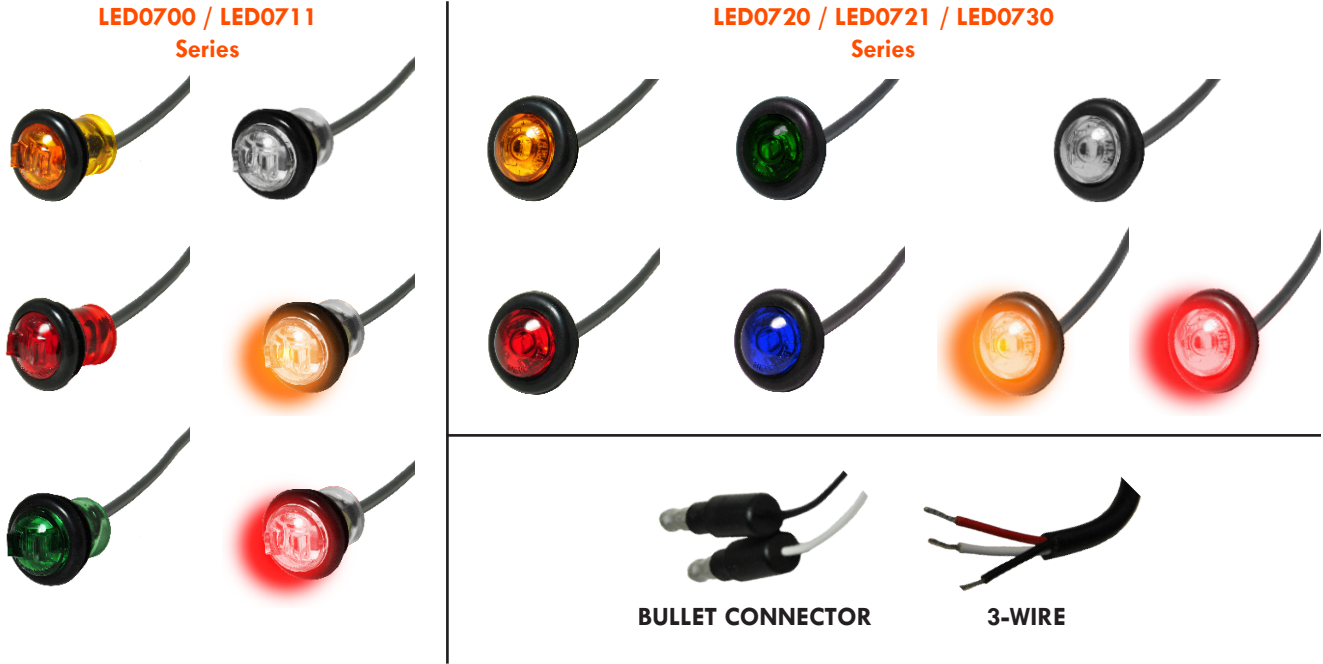

Sealed Polycarbonate Lens  
Mounts in Maximum 0.81" hole  
Amp Draw: 0.04 @ 12V

| Part No.  | Colour | Function         | Lens Type    | SAE  | Voltage   | Connection                   |
|-----------|--------|------------------|--------------|------|-----------|------------------------------|
| LED0700MA | Amber  | Clearance Marker | Double Point | PC   | 12V - 24V | (2x) Lead Wires              |
| LED0700MR | Red    | Clearance Marker | Double Point | PC   | 12V - 24V | (2x) Lead Wires              |
| LED0700A  | Amber  | Clearance Marker | Double Point | PC   | 12V       | (2x) Lead Wires              |
| LED0700R  | Red    | Clearance Marker | Double Point | PC   | 12V       | (2x) Lead Wires              |
| LED0700G  | Green  | Utility          | Double Point | -    | 12V       | (2x) Lead Wires              |
| LED0711A  | Amber  | Clearance Marker | Double Point | PC   | 12V       | (2x) 0.18" Bullet Connectors |
| LED0711R  | Red    | Clearance Marker | Double Point | PC   | 12V       | (2x) 0.18" Bullet Connectors |
| LED0720A  | Amber  | Clearance Marker | Smooth Lens  | P2PC | 12V       | (2x) Lead Wires              |
| LED0720R  | Red    | Clearance Marker | Smooth Lens  | P2PC | 12V       | (2x) Lead Wires              |
| LED0720B  | Blue   | Utility          | Smooth Lens  | -    | 12V       | (2x) Lead Wires              |
| LED0720G  | Green  | Utility          | Smooth Lens  | -    | 12V       | (2x) Lead Wires              |
| LED0721A  | Amber  | Clearance Marker | Smooth Lens  | P2PC | 12V       | (2x) 0.18" Bullet Connectors |
| LED0721R  | Red    | Clearance Marker | Smooth Lens  | P2PC | 12V       | (2x) 0.18" Bullet Connectors |
| LED0730A  | Amber  | Clearance Marker | Smooth Lens  | PC   | 12V       | (3x) Lead Wires              |
| LED0730R  | Red    | Clearance Marker | Smooth Lens  | PC   | 12V       | (3x) Lead Wires              |

## CLEAR LENS LAMPS

|           |       |                  |              |      |     |                              |
|-----------|-------|------------------|--------------|------|-----|------------------------------|
| LED0700CA | Amber | Clearance Marker | Double Point | PC   | 12V | (2x) Lead Wires              |
| LED0700CR | Red   | Clearance Marker | Double Point | PC   | 12V | (2x) Lead Wires              |
| LED0700C  | White | Utility          | Double Point | -    | 12V | (2x) Lead Wires              |
| LED0720CA | Amber | Clearance Marker | Smooth Lens  | P2PC | 12V | (2x) Lead Wires              |
| LED0720CR | Red   | Clearance Marker | Smooth Lens  | P2PC | 12V | (2x) Lead Wires              |
| LED0720C  | White | Utility          | Smooth Lens  | -    | 12V | (2x) Lead Wires              |
| LED0721CA | Amber | Clearance Marker | Smooth Lens  | P2PC | 12V | (2x) 0.18" Bullet Connectors |
| LED0721CR | Red   | Clearance Marker | Smooth Lens  | P2PC | 12V | (2x) 0.18" Bullet Connectors |

For Retail Bag, add the suffix 'P' to the end of the Part No.

Grommets GR0700  
Female Bullet Connectors PT2022, PT2022-100R  
Decorative Bezels BZ0700

# DECORATIVE CHROME BEZEL LAMPS

CLEARANCE MARKER LAMPS  
FEUX D'ENCOMBREMENT ET DE POSITION

LED sealed clearance marker lamps are hermetically sealed to keep out road contaminants and moisture. Solid state circuit boards. LED lamps provide long life, low amp draw, and are resistant to vibration. All lamps, except decorative, are compliant with DOT FMVSS108 & MOT CMVSS108 safety standards and are coded accordingly. Lamps use standard 2-prong pigtailed where lead wires are not used.

## 4 Diodes Series

Sealed Polycarbonate Lens • 12V

| Part No.                           | Colour | Function         | SAE | Amp Draw |
|------------------------------------|--------|------------------|-----|----------|
| <b>3.56" L x 1.5" H x 0.75" D</b>  |        |                  |     |          |
| LED0615-4A                         | Amber  | Clearance Marker | P2  | 0.07     |
| LED0615-4R                         | Red    | Clearance Marker | P2  | 0.06     |
| <b>4.69" L x 1.5" H x 0.75" D</b>  |        |                  |     |          |
| LED1115-4A                         | Amber  | Clearance Marker | P2  | 0.07     |
| LED1115-4R                         | Red    | Clearance Marker | P2  | 0.06     |
| LED1115-4C                         | White  | Utility          | -   | 0.03     |
| <b>5.75" L x 1.63" H x 0.88" D</b> |        |                  |     |          |
| LED1315-4A                         | Amber  | Clearance Marker | P2  | 0.07     |
| LED1315-4R                         | Red    | Clearance Marker | P2  | 0.06     |
| LED1315-4C                         | White  | Utility          | -   | 0.03     |

For Retail Bag, add the suffix 'P' to the end of the Part No.

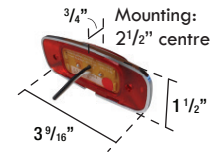

LED0615

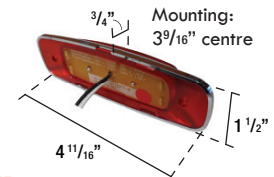

LED1115

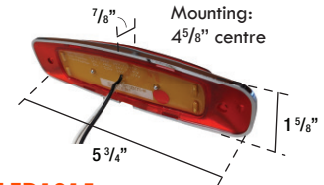

LED1315

## 6 Diodes Series

Sealed Polycarbonate Lens • 12V

| Part No.                           | Colour | Function         | SAE | Amp Draw |
|------------------------------------|--------|------------------|-----|----------|
| <b>4" L x 1.38" H x 0.75" D</b>    |        |                  |     |          |
| LED0725-6A                         | Amber  | Clearance Marker | P2  | 0.04     |
| LED0725-6R                         | Red    | Clearance Marker | P2  | 0.04     |
| <b>4" L x 1.63" H x 0.75" D</b>    |        |                  |     |          |
| LED1025-6A                         | Amber  | Clearance Marker | P2  | 0.04     |
| LED1025-6R                         | Red    | Clearance Marker | P2  | 0.04     |
| <b>6.63" L x 2.13" H x 0.88" D</b> |        |                  |     |          |
| LED1545-6A                         | Amber  | Clearance Marker | P2  | 0.05     |
| LED1545-6R                         | Red    | Clearance Marker | P2  | 0.05     |

For Retail Bag, add the suffix 'P' to the end of the Part No.



LED0725

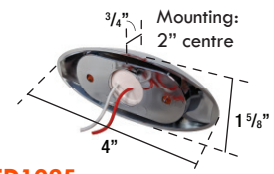
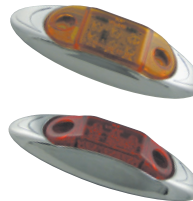

LED1025

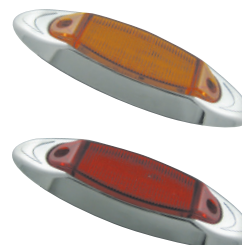

LED1545

# RECTANGULAR LAMPS

## 7 Diodes LED Series - Slim Line

Sealed Polycarbonate Lens & Base • 12V  
Bulb Size: 0.18"

| Part No.        | Colour | Function         | SAE | Amp Draw |
|-----------------|--------|------------------|-----|----------|
| <b>LED0750A</b> | Amber  | Clearance Marker | P2  | 0.03     |
| <b>LED0750R</b> | Red    | Clearance Marker | P2  | 0.03     |

For Retail Bag, add the suffix 'P' to the end of the Part No.

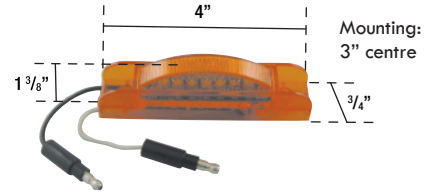

**Female Bullet Connectors** PT2022, PT2022-100R

## Incandescent Series - Slim Line

Acrylic Lens & ABS Base • 12V  
Bulb Size: #193

| Part No.       | Colour | Function         | SAE | Amp Draw |
|----------------|--------|------------------|-----|----------|
| <b>ML1030A</b> | Amber  | Clearance Marker | P2  | 0.27     |
| <b>ML1030R</b> | Red    | Clearance Marker | P2  | 0.27     |

For Retail Bag, add the suffix 'P' to the end of the Part No.

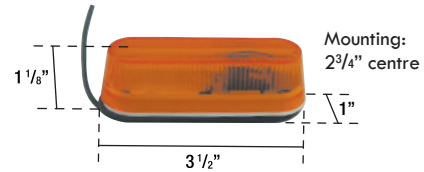

**Replacement Lens** MLR1030A (amber), MLR1030R (red)  
**Replacement Bulb** HB194

## 8 Diodes LED Series - Turtle Back

Sealed Polycarbonate Lens & Base • 12V  
Bulb Size: 0.18"

| Part No.         | Colour | Function                       | SAE | Amp Draw |
|------------------|--------|--------------------------------|-----|----------|
| <b>LR2060-8A</b> | Amber  | Clearance Marker/<br>Reflector | AP2 | 0.05     |
| <b>LR2060-8R</b> | Red    | Clearance Marker/<br>Reflector | AP2 | 0.05     |

For Retail Bag, add the suffix 'P' to the end of the Part No.

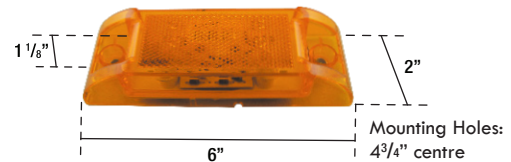

## Incandescent Series - Low Profile

Acrylic Lens & ABS Base • 12V  
Bulb Size: #193

| Part No.       | Colour | Function                       | SAE | Amp Draw |
|----------------|--------|--------------------------------|-----|----------|
| <b>ML2044A</b> | Amber  | Clearance Marker/<br>Reflector | AP2 | 0.27     |
| <b>ML2044R</b> | Red    | Clearance Marker/<br>Reflector | AP2 | 0.27     |

For Retail Bag, add the suffix 'P' to the end of the Part No.

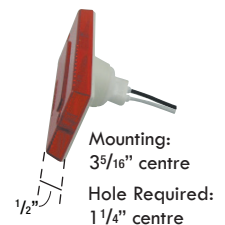
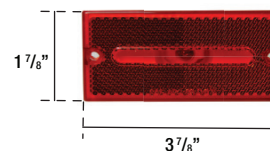
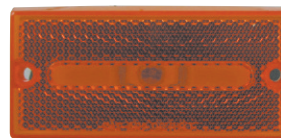



# 4" BULLSEYE LAMPS

CLEARANCE MARKER LAMPS  
FEUX D'ENCOMBREMENT ET DE POSITION

LED sealed clearance marker lamps are hermetically sealed to keep out road contaminants and moisture. Solid state circuit boards. LED lamps provide long life, low amp draw, and are resistant to vibration. All lamps, except decorative, are compliant with DOT FMVSS108 & MOT CMVSS108 safety standards and are coded accordingly. Lamps use standard 2-prong pigtails where lead wires are not used.



## 16 Diodes LED Series

Sealed Polycarbonate Lens & Base • 12V  
2x Lead Wires

| Part No.           | Colour | Function         | SAE | Amp Draw |
|--------------------|--------|------------------|-----|----------|
| <b>LED2040-16A</b> | Amber  | Clearance Marker | P2  | 0.1      |
| <b>LED2040-16R</b> | Red    | Clearance Marker | P2  | 0.1      |

For Retail Bag, add the suffix 'P' to the end of the Part No.



## Incandescent Series

Acrylic Lens & ABS Base • 12V  
2x Lead Wires  
Bulb: (x2) #193

| Part No.       | Colour | Function         | SAE | Amp Draw |
|----------------|--------|------------------|-----|----------|
| <b>ML2040A</b> | Amber  | Clearance Marker | P2  | 0.54     |
| <b>ML2040B</b> | Blue   | Decorative       | -   | 0.54     |
| <b>ML2040C</b> | Clear  | Decorative       | -   | 0.54     |
| <b>ML2040G</b> | Green  | Decorative       | -   | 0.54     |
| <b>ML2040R</b> | Red    | Clearance Marker | P2  | 0.54     |

For Retail Bag, add the suffix 'P' to the end of the Part No.

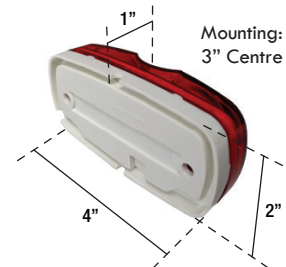

**Replacement Lens** MLR2040A (amber), MLR2040R (red), MLR2040B (blue), MLR2040C (clear), MLR2040G (green)  
**Replacement Bulb** HB194

# 2" RECTANGULAR LAMPS

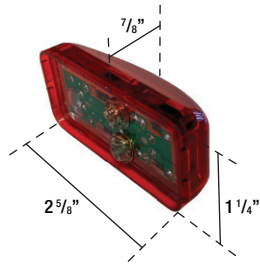

## 1 Diode Series

Sealed Polycarbonate Lens & Base • 12V

| Part No.          | Colour | Function         | SAE | Amp Draw |
|-------------------|--------|------------------|-----|----------|
| <b>LED1225-1A</b> | Amber  | Clearance Marker | P2  | 0.04     |
| <b>LED1225-1R</b> | Red    | Clearance Marker | P2  | 0.04     |

For Retail Bag, add the suffix 'P' to the end of the Part No.

|                              |                               |
|------------------------------|-------------------------------|
| <b>Grommets</b>              | GR1225                        |
| <b>Pigtails</b>              | PT6020 / PT6021 / PT6022      |
| <b>Base Mounts</b>           | BM1020C / BM1020CB / BM1020CG |
| <b>Base Mounts w/ Ground</b> | BM1021C / BM1021CB / BM1021CG |



| AMBER KITS        |   |
|-------------------|---|
| <b>KTL2132-1A</b> | Amber • Black Mount w/ Built-In Ground & Hotwire  |
| <b>KTL2133-1A</b> | Amber • Gray Mount w/ Built-In Ground & Hotwire   |
| <b>KTL2134-1A</b> | Amber • Chrome Mount w/ Built-In Ground & Hotwire |
| <b>KTL2126-1A</b> | Amber • Chrome Mount • Single Contact Pigtail     |
| <b>KTL2128-1A</b> | Amber • Black Mount • Single Contact Pigtail      |
| <b>KTL2129-1A</b> | Amber • Gray Mount • Single Contact Pigtail       |

| RED KITS          |   |
|-------------------|---|
| <b>KTL2132-1R</b> | Red • Black Mount w/ Built-In Ground & Hotwire  |
| <b>KTL2133-1R</b> | Red • Gray Mount w/ Built-In Ground & Hotwire   |
| <b>KTL2134-1R</b> | Red • Chrome Mount w/ Built-In Ground & Hotwire |
| <b>KTL2126-1R</b> | Red • Chrome Mount • Single Contact Pigtail     |
| <b>KTL2128-1R</b> | Red • Black Mount • Single Contact Pigtail      |
| <b>KTL2129-1R</b> | Red • Gray Mount • Single Contact Pigtail       |

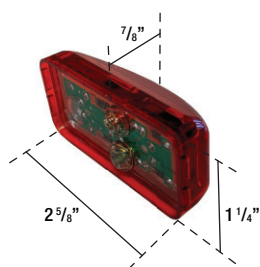

## 3 Diode Series

Sealed Polycarbonate Lens & Base • 12V

| Part No.          | Colour | Function         | SAE  | Amp Draw |
|-------------------|--------|------------------|------|----------|
| <b>LED1225-3A</b> | Amber  | Clearance Marker | P2PC | 0.05     |
| <b>LED1225-3R</b> | Red    | Clearance Marker | P2PC | 0.05     |

For Retail Bag, add the suffix 'P' to the end of the Part No.

|                              |                               |
|------------------------------|-------------------------------|
| <b>Grommets</b>              | GR1225                        |
| <b>Pigtails</b>              | PT6020 / PT6021 / PT6022      |
| <b>Base Mounts</b>           | BM1020C / BM1020CB / BM1020CG |
| <b>Base Mounts w/ Ground</b> | BM1021C / BM1021CB / BM1021CG |



| AMBER KITS        |   |
|-------------------|---|
| <b>KTL2132-3A</b> | Amber • Black Mount w/ Built-In Ground & Hotwire  |
| <b>KTL2133-3A</b> | Amber • Gray Mount w/ Built-In Ground & Hotwire   |
| <b>KTL2134-3A</b> | Amber • Chrome Mount w/ Built-In Ground & Hotwire |
| <b>KTL2126-3A</b> | Amber • Chrome Mount • Single Contact Pigtail     |
| <b>KTL2128-3A</b> | Amber • Black Mount • Single Contact Pigtail      |
| <b>KTL2129-3A</b> | Amber • Gray Mount • Single Contact Pigtail       |

| RED KITS          |   |
|-------------------|---|
| <b>KTL2132-3R</b> | Red • Black Mount w/ Built-In Ground & Hotwire  |
| <b>KTL2133-3R</b> | Red • Gray Mount w/ Built-In Ground & Hotwire   |
| <b>KTL2134-3R</b> | Red • Chrome Mount w/ Built-In Ground & Hotwire |
| <b>KTL2126-3R</b> | Red • Chrome Mount • Single Contact Pigtail     |
| <b>KTL2128-3R</b> | Red • Black Mount • Single Contact Pigtail      |
| <b>KTL2129-3R</b> | Red • Gray Mount • Single Contact Pigtail       |

# 2" RECTANGULAR LAMPS

CLEARANCE MARKER LAMPS  
FEUX D'ENCOMBREMENT ET DE POSITION

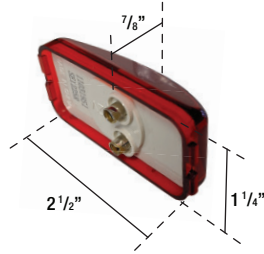

## Incandescent Series

Sealed Polycarbonate Lens & Base • 12V

| Part No.       | Colour | Function         | SAE | Amp Draw |
|----------------|--------|------------------|-----|----------|
| <b>SE1225A</b> | Amber  | Clearance Marker | P3  | 0.33     |
| <b>SE1225R</b> | Red    | Clearance Marker | P3  | 0.33     |

For Retail Bag, add the suffix 'P' to the end of the Part No.

|                              |                               |
|------------------------------|-------------------------------|
| <b>Grommets</b>              | GR1225                        |
| <b>Pigtails</b>              | PT6020 / PT6021 / PT6022      |
| <b>Base Mounts</b>           | BM1020C / BM1020CB / BM1020CG |
| <b>Base Mounts w/ Ground</b> | BM1021C / BM1021CB / BM1021CG |
| <b>Rail Mounts</b>           | BM1020R / BM1020RB / BM1020RG |

| AMBER KITS     |   |
|----------------|---|
| <b>KT2132A</b> | Amber • Black Mount w/ Built-In Ground & Hotwire  |
| <b>KT2133A</b> | Amber • Gray Mount w/ Built-In Ground & Hotwire   |
| <b>KT2134A</b> | Amber • Chrome Mount w/ Built-In Ground & Hotwire |
| <b>KT2126A</b> | Amber • Chrome Mount • Single Contact Pigtail     |
| <b>KT2128A</b> | Amber • Black Mount • Single Contact Pigtail      |
| <b>KT2129A</b> | Amber • Gray Mount • Single Contact Pigtail       |
| <b>KT3127A</b> | Amber • White Rail Mount • Single Contact Pigtail |
| <b>KT2130A</b> | Amber • Black Rail Mount • Single Contact Pigtail |
| <b>KT2131A</b> | Amber • Gray Rail Mount • Single Contact Pigtail  |

| RED KITS       |   |
|----------------|---|
| <b>KT2132R</b> | Red • Black Mount w/ Built-In Ground & Hotwire  |
| <b>KT2133R</b> | Red • Gray Mount w/ Built-In Ground & Hotwire   |
| <b>KT2134R</b> | Red • Chrome Mount w/ Built-In Ground & Hotwire |
| <b>KT2126R</b> | Red • Chrome Mount • Single Contact Pigtail     |
| <b>KT2128R</b> | Red • Black Mount • Single Contact Pigtail      |
| <b>KT2129R</b> | Red • Gray Mount • Single Contact Pigtail       |
| <b>KT3127R</b> | Red • White Rail Mount • Single Contact Pigtail |
| <b>KT2130R</b> | Red • Black Rail Mount • Single Contact Pigtail |
| <b>KT2131R</b> | Red • Gray Rail Mount • Single Contact Pigtail  |



## SUPER COMPACT

for easy storage



## Retractable 5th Wheel Pin Puller

| Part No.       | Material | Qty  |
|----------------|----------|------|
| <b>PP-1124</b> | Iron     | 1 pc |

# 4" RECTANGULAR LAMPS

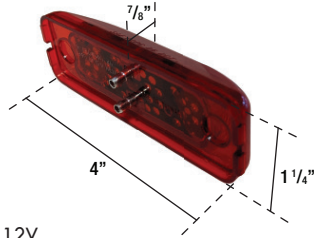

## 4 Diode Series

Sealed Polycarbonate Lens & Base • 12V

| Part No.          | Colour | Function         | SAE  | Amp Draw |
|-------------------|--------|------------------|------|----------|
| <b>LED1040-4A</b> | Amber  | Clearance Marker | P2PC | 0.02     |
| <b>LED1040-4R</b> | Red    | Clearance Marker | P2PC | 0.02     |

For Retail Bag, add the suffix 'P' to the end of the Part No.

**Pigtails** PT6020 / PT6021 / PT6022  
**Base Mounts w/ Ground** BM1040B / BM1040BB / BM1040BC

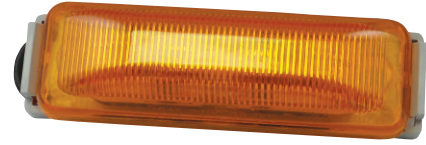

| AMBER KITS        |   |
|-------------------|---|
| <b>KTL2140-4A</b> | Amber • Gray Mount w/ Built-In Ground & Hotwire   |
| <b>KTL2143-4A</b> | Amber • Chrome Mount w/ Built-In Ground & Hotwire |

| RED KITS          |   |
|-------------------|---|
| <b>KTL2140-4R</b> | Red • Gray Mount w/ Built-In Ground & Hotwire   |
| <b>KTL2143-4R</b> | Red • Chrome Mount w/ Built-In Ground & Hotwire |

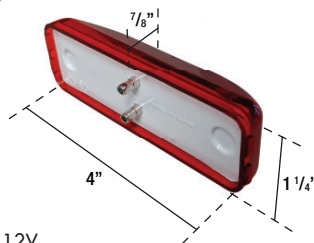
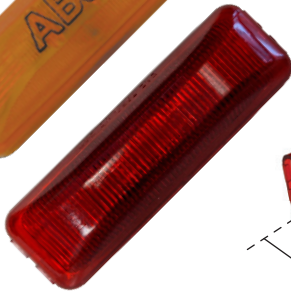

## Incandescent Series

Sealed Polycarbonate Lens & Base • 12V

| Part No.       | Colour | Function         | SAE  | Amp Draw |
|----------------|--------|------------------|------|----------|
| <b>SE1040A</b> | Amber  | Clearance Marker | P2PC | 0.05     |
| <b>SE1040R</b> | Red    | Clearance Marker | P2PC | 0.05     |

### ABS Brake System Indicator

**SE1040ABS** Amber Lens is silk screened with ABS logo

For Retail Bag, add the suffix 'P' to the end of the Part No.

**Pigtails** PT6020 / PT6021 / PT6022  
**Base Mounts w/ Ground** BM1040B / BM1040BB / BM1040BC



| AMBER KITS     |   |
|----------------|---|
| <b>KT2140A</b> | Amber • Gray Mount w/ Built-In Ground & Hotwire   |
| <b>KT2142A</b> | Amber • Black Mount w/ Built-In Ground & Hotwire  |
| <b>KT2143A</b> | Amber • Chrome Mount w/ Built-In Ground & Hotwire |

| RED KITS       |   |
|----------------|---|
| <b>KT2140R</b> | Red • Gray Mount w/ Built-In Ground & Hotwire   |
| <b>KT2142R</b> | Red • Black Mount w/ Built-In Ground & Hotwire  |
| <b>KT2143R</b> | Red • Chrome Mount w/ Built-In Ground & Hotwire |

# SPECIALTY MARKER LAMPS

CLEARANCE MARKER LAMPS  
FEUX D'ENCOMBREMENT ET DE POSITION

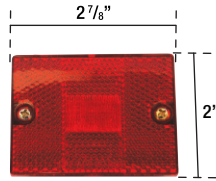

Height: 1"  
Stud Size: 1/4"

## 6 Diodes Series - Stud Mount

Acrylic Lens & ABS Base • 12V

| Part No.         | Colour | Function         | SAE | Amp Draw |
|------------------|--------|------------------|-----|----------|
| <b>LR2020-6A</b> | Amber  | Clearance Marker | AP2 | 0.02     |
| <b>LR2020-6R</b> | Red    | Clearance Marker | AP2 | 0.02     |

For Retail Bag, add the suffix 'P' to the end of the Part No.

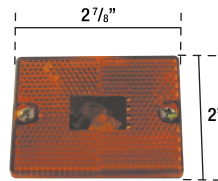
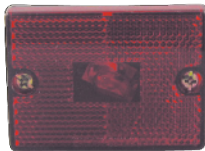

Height: 1"  
Stud Size: 1/4"

## Incandescent Series - Stud Mount

Acrylic Lens & ABS Base • 12V

Bulb Size: #193

| Part No.       | Colour | Function         | SAE | Amp Draw |
|----------------|--------|------------------|-----|----------|
| <b>MR2020A</b> | Amber  | Clearance Marker | AP2 | 0.27     |
| <b>MR2020R</b> | Red    | Clearance Marker | AP2 | 0.27     |

For Retail Bag, add the suffix 'P' to the end of the Part No.

Replacement Lens      MRR2020A (amber), MRR2020R (red)  
Replacement Bulb      HB194



## 15 Diodes Series - Cab Marker

Acrylic Lens & ABS Base • 12V

Bulb Size: #193

| Part No.        | Colour | Function                            | SAE | Amp Draw |
|-----------------|--------|-------------------------------------|-----|----------|
| <b>LED3501R</b> | Red    | Clearance Marker/<br>Identification | P2  | 0.18     |

For Retail Bag, add the suffix 'P' to the end of the Part No.



# 2" ROUND LED LAMPS

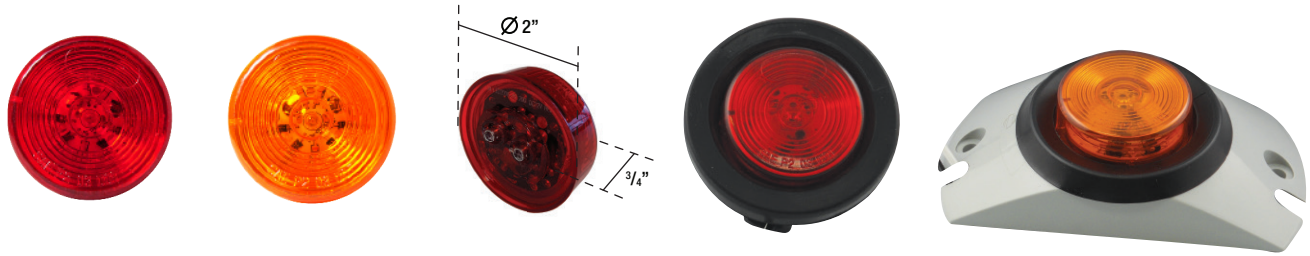

## 1 Diode Series

Sealed Polycarbonate Lens & Base • 12V

| Part No.          | Colour | Function         | SAE | Amp Draw |
|-------------------|--------|------------------|-----|----------|
| <b>LED2000-1A</b> | Amber  | Clearance Marker | P2  | 0.04     |
| <b>LED2000-1R</b> | Red    | Clearance Marker | P2  | 0.04     |

For Retail Bag, add the suffix 'P' to the end of the Part No.

|                          |                                   |
|--------------------------|-----------------------------------|
| <b>Grommets</b>          | GR2000 / GR2001                   |
| <b>Pigtails</b>          | PT6020 / PT6021 / PT6022          |
| <b>Flange</b>            | FL2000 / FL2001 / FL2002 / FL2005 |
| <b>Mounting Brackets</b> | MB2000                            |
| <b>Decorative Bezels</b> | BZ2000 / BZ2000V                  |
| <b>Branch Deflectors</b> | BD2000                            |

| AMBER KITS          |  |
|---------------------|--|
| <b>LEDF2000-1A0</b> | Amber • White ABS Flange   |
| <b>LEDF2000-1A1</b> | Amber • Black ABS Flange   |
| <b>LEDF2000-1A2</b> | Amber • Gray ABS Flange  |
| <b>LEDF2000-1A5</b> | Amber • Chrome ABS Flange  |
| <b>KTL3201-1A</b>   | Amber • Branch Deflector • Single Contact Pigtail                        |
| <b>KTL2000-1A</b>   | Amber • Open Grommet • Single Contact Pigtail                            |
| <b>KTL2001-1A</b>   | Amber • Closed Grommet • Single Contact Pigtail                          |
| <b>KTLM2001-1A</b>  | Amber • Closed Grommet • Single Contact Pigtail • Steel Mounting Bracket |

| RED KITS            |  |
|---------------------|--|
| <b>LEDF2000-1R0</b> | Red • White ABS Flange   |
| <b>LEDF2000-1R1</b> | Red • Black ABS Flange   |
| <b>LEDF2000-1R2</b> | Red • Gray ABS Flange  |
| <b>LEDF2000-1R5</b> | Red • Chrome ABS Flange  |
| <b>KTL3201-1R</b>   | Red • Branch Deflector • Single Contact Pigtail                        |
| <b>KTL2000-1R</b>   | Red • Open Grommet • Single Contact Pigtail                            |
| <b>KTL2001-1R</b>   | Red • Closed Grommet • Single Contact Pigtail                          |
| <b>KTLM2001-1R</b>  | Red • Closed Grommet • Single Contact Pigtail • Steel Mounting Bracket |

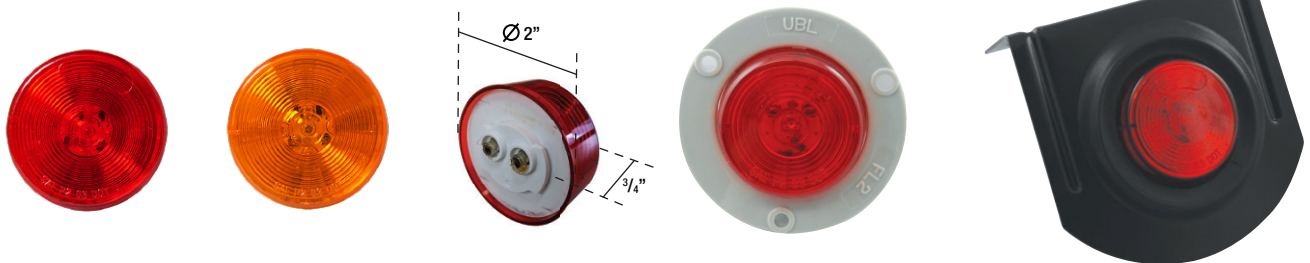

## 1 Diode (Multi-Voltage) Series

Sealed Polycarbonate Lens & Base

**MULTI-VOLTAGE**  
**12V - 24V**

| Part No.           | Colour | Function         | SAE | Amp Draw |
|--------------------|--------|------------------|-----|----------|
| <b>LED2000M-1A</b> | Amber  | Clearance Marker | P2  | 0.04     |
| <b>LED2000M-1R</b> | Red    | Clearance Marker | P2  | 0.04     |

For Retail Bag, add the suffix 'P' to the end of the Part No.

|                          |                          |
|--------------------------|--------------------------|
| <b>Grommets</b>          | GR2000 / GR2001          |
| <b>Pigtails</b>          | PT6020 / PT6021 / PT6022 |
| <b>Mounting Brackets</b> | MB2000                   |
| <b>Decorative Bezels</b> | BZ2000 / BZ2000V         |
| <b>Branch Deflectors</b> | BD2000                   |

| AMBER KITS          |  |
|---------------------|--|
| <b>KTL2000M-1A</b>  | Amber • Open Grommet • Single Contact Pigtail                            |
| <b>KTL2001M-1A</b>  | Amber • Closed Grommet • Single Contact Pigtail                          |
| <b>KTLM2001M-1A</b> | Amber • Closed Grommet • Single Contact Pigtail • Steel Mounting Bracket |

| RED KITS            |  |
|---------------------|--|
| <b>KTL2000M-1R</b>  | Red • Open Grommet • Single Contact Pigtail                            |
| <b>KTL2001M-1R</b>  | Red • Closed Grommet • Single Contact Pigtail                          |
| <b>KTLM2001M-1R</b> | Red • Closed Grommet • Single Contact Pigtail • Steel Mounting Bracket |

# 2" ROUND LED LAMPS

CLEARANCE MARKER LAMPS  
FEUX D'ENCOMBREMENT ET DE POSITION



## 4 Diode Series

Sealed Polycarbonate Lens & Base • 12V

| Part No.          | Colour | Function         | SAE | Amp Draw |
|-------------------|--------|------------------|-----|----------|
| <b>LED2000-4A</b> | Amber  | Clearance Marker | P2  | 0.06     |
| <b>LED2000-4R</b> | Red    | Clearance Marker | P2  | 0.06     |

For Retail Bag, add the suffix 'P' to the end of the Part No.

|                          |                                   |
|--------------------------|-----------------------------------|
| <b>Grommets</b>          | GR2000 / GR2001                   |
| <b>Pigtails</b>          | PT6020 / PT6021 / PT6022          |
| <b>Flange</b>            | FL2000 / FL2001 / FL2002 / FL2005 |
| <b>Mounting Brackets</b> | MB2000                            |
| <b>Decorative Bezels</b> | BZ2000 / BZ2000V                  |
| <b>Branch Deflectors</b> | BD2000                            |

| AMBER KITS          |  |
|---------------------|--|
| <b>LEDF2000-4A0</b> | Amber • White ABS Flange   |
| <b>LEDF2000-4A1</b> | Amber • Black ABS Flange   |
| <b>LEDF2000-4A2</b> | Amber • Gray ABS Flange  |
| <b>LEDF2000-4A5</b> | Amber • Chrome ABS Flange  |
| <b>KTL3201-4A</b>   | Amber • Branch Deflector • Single Contact Pigtail                        |
| <b>KTL2000-4A</b>   | Amber • Open Grommet • Single Contact Pigtail                            |
| <b>KTL2001-4A</b>   | Amber • Closed Grommet • Single Contact Pigtail                          |
| <b>KTLM2001-4A</b>  | Amber • Closed Grommet • Single Contact Pigtail • Steel Mounting Bracket |

| RED KITS            |  |
|---------------------|--|
| <b>LEDF2000-4R0</b> | Red • White ABS Flange   |
| <b>LEDF2000-4R1</b> | Red • Black ABS Flange   |
| <b>LEDF2000-4R2</b> | Red • Gray ABS Flange  |
| <b>LEDF2000-4R5</b> | Red • Chrome ABS Flange  |
| <b>KTL3201-4R</b>   | Red • Branch Deflector • Single Contact Pigtail                        |
| <b>KTL2000-4R</b>   | Red • Open Grommet • Single Contact Pigtail                            |
| <b>KTL2001-4R</b>   | Red • Closed Grommet • Single Contact Pigtail                          |
| <b>KTLM2001-4R</b>  | Red • Closed Grommet • Single Contact Pigtail • Steel Mounting Bracket |

# 2" ROUND LED LAMPS



## 6 Diode Series

Sealed Polycarbonate Lens & Base • 12V

| Part No.          | Colour | Function         | SAE | Amp Draw |
|-------------------|--------|------------------|-----|----------|
| <b>LED2000-6A</b> | Amber  | Clearance Marker | P2  | 0.04     |
| <b>LED2000-6R</b> | Red    | Clearance Marker | P2  | 0.06     |

### CLEAR LENS LAMPS

|                    |       |                  |    |      |
|--------------------|-------|------------------|----|------|
| <b>LED2000C-6A</b> | Amber | Clearance Marker | P2 | 0.04 |
| <b>LED2000C-6R</b> | Red   | Clearance Marker | P2 | 0.06 |

For Retail Bag, add the suffix 'P' to the end of the Part No.

|                          |                                   |
|--------------------------|-----------------------------------|
| <b>Grommets</b>          | GR2000 / GR2001                   |
| <b>Pigtails</b>          | PT6020 / PT6021 / PT6022          |
| <b>Flange</b>            | FL2000 / FL2001 / FL2002 / FL2005 |
| <b>Mounting Brackets</b> | MB2000                            |
| <b>Decorative Bezels</b> | BZ2000 / BZ2000V                  |
| <b>Branch Deflectors</b> | BD2000                            |



| AMBER KITS          |  |
|---------------------|--|
| <b>LEDF2000-6A0</b> | Amber • White ABS Flange   |
| <b>LEDF2000-6A1</b> | Amber • Black ABS Flange   |
| <b>LEDF2000-6A2</b> | Amber • Gray ABS Flange  |
| <b>LEDF2000-6A5</b> | Amber • Chrome ABS Flange  |
| <b>KTL3201-6A</b>   | Amber • Branch Deflector • Single Contact Pigtail                        |
| <b>KTL2000-6A</b>   | Amber • Open Grommet • Single Contact Pigtail                            |
| <b>KTL2001-6A</b>   | Amber • Closed Grommet • Single Contact Pigtail                          |
| <b>KTLM2001-6A</b>  | Amber • Closed Grommet • Single Contact Pigtail • Steel Mounting Bracket |

| RED KITS            |  |
|---------------------|--|
| <b>LEDF2000-6R0</b> | Red • White ABS Flange   |
| <b>LEDF2000-6R1</b> | Red • Black ABS Flange   |
| <b>LEDF2000-6R2</b> | Red • Gray ABS Flange  |
| <b>LEDF2000-6R5</b> | Red • Chrome ABS Flange  |
| <b>KTL3201-6R</b>   | Red • Branch Deflector • Single Contact Pigtail                        |
| <b>KTL2000-6R</b>   | Red • Open Grommet • Single Contact Pigtail                            |
| <b>KTL2001-6R</b>   | Red • Closed Grommet • Single Contact Pigtail                          |
| <b>KTLM2001-6R</b>  | Red • Closed Grommet • Single Contact Pigtail • Steel Mounting Bracket |

| AMBER KITS - CLEAR LENS |  |
|-------------------------|--|
| <b>LEDF2000C-6A0</b>    | Amber • White ABS Flange   |
| <b>LEDF2000C-6A1</b>    | Amber • Black ABS Flange   |
| <b>LEDF2000C-6A2</b>    | Amber • Gray ABS Flange  |
| <b>LEDF2000C-6A5</b>    | Amber • Chrome ABS Flange  |
| <b>KTL3201C-6A</b>      | Amber • Branch Deflector • Single Contact Pigtail                        |
| <b>KTL2000C-6A</b>      | Amber • Open Grommet • Single Contact Pigtail                            |
| <b>KTL2001C-6A</b>      | Amber • Closed Grommet • Single Contact Pigtail                          |
| <b>KTLM2001C-6A</b>     | Amber • Closed Grommet • Single Contact Pigtail • Steel Mounting Bracket |

| RED KITS - CLEAR LENS |  |
|-----------------------|--|
| <b>LEDF2000C-6R0</b>  | Red • White ABS Flange   |
| <b>LEDF2000C-6R1</b>  | Red • Black ABS Flange   |
| <b>LEDF2000C-6R2</b>  | Red • Gray ABS Flange  |
| <b>LEDF2000C-6R5</b>  | Red • Chrome ABS Flange  |
| <b>KTL3201C-6R</b>    | Red • Branch Deflector • Single Contact Pigtail                        |
| <b>KTL2000C-6R</b>    | Red • Open Grommet • Single Contact Pigtail                            |
| <b>KTL2001C-6R</b>    | Red • Closed Grommet • Single Contact Pigtail                          |
| <b>KTLM2001C-6R</b>   | Red • Closed Grommet • Single Contact Pigtail • Steel Mounting Bracket |



# 2" ROUND LED LAMPS

CLEARANCE MARKER LAMPS  
FEUX D'ENCOMBREMENT ET DE POSITION



## 9 Diode Series

Sealed Polycarbonate Lens & Base • 12V

| Part No.          | Colour | Function         | SAE  | Amp Draw |
|-------------------|--------|------------------|------|----------|
| <b>LED2000-9A</b> | Amber  | Clearance Marker | P3PC | 0.03     |
| <b>LED2000-9R</b> | Red    | Clearance Marker | P3PC | 0.03     |

For Retail Bag, add the suffix 'P' to the end of the Part No.

|                          |                                   |
|--------------------------|-----------------------------------|
| <b>Grommets</b>          | GR2000 / GR2001                   |
| <b>Pigtails</b>          | PT6020 / PT6021 / PT6022          |
| <b>Flange</b>            | FL2000 / FL2001 / FL2002 / FL2005 |
| <b>Mounting Brackets</b> | MB2000                            |
| <b>Decorative Bezels</b> | BZ2000 / BZ2000V                  |
| <b>Branch Deflectors</b> | BD2000                            |

| AMBER KITS          |  |
|---------------------|--|
| <b>LEDF2000-9A0</b> | Amber • White ABS Flange   |
| <b>LEDF2000-9A1</b> | Amber • Black ABS Flange   |
| <b>LEDF2000-9A2</b> | Amber • Gray ABS Flange  |
| <b>LEDF2000-9A5</b> | Amber • Chrome ABS Flange  |
| <b>KTL3201-9A</b>   | Amber • Branch Deflector • Single Contact Pigtail                        |
| <b>KTL2000-9A</b>   | Amber • Open Grommet • Single Contact Pigtail                            |
| <b>KTL2001-9A</b>   | Amber • Closed Grommet • Single Contact Pigtail                          |
| <b>KTLM2001-9A</b>  | Amber • Closed Grommet • Single Contact Pigtail • Steel Mounting Bracket |

| RED KITS            |  |
|---------------------|--|
| <b>LEDF2000-9R0</b> | Red • White ABS Flange   |
| <b>LEDF2000-9R1</b> | Red • Black ABS Flange   |
| <b>LEDF2000-9R2</b> | Red • Gray ABS Flange  |
| <b>LEDF2000-9R5</b> | Red • Chrome ABS Flange  |
| <b>KTL3201-9R</b>   | Red • Branch Deflector • Single Contact Pigtail                        |
| <b>KTL2000-9R</b>   | Red • Open Grommet • Single Contact Pigtail                            |
| <b>KTL2001-9R</b>   | Red • Closed Grommet • Single Contact Pigtail                          |
| <b>KTLM2001-9R</b>  | Red • Closed Grommet • Single Contact Pigtail • Steel Mounting Bracket |



## 10 Diode (Multi-Voltage) Series

Sealed Polycarbonate Lens & Base

**MULTI-VOLTAGE**  
**12V - 24V**

| Part No.            | Colour | Function         | SAE | Amp Draw |
|---------------------|--------|------------------|-----|----------|
| <b>LED2000M-10A</b> | Amber  | Clearance Marker | P2  | 0.03     |
| <b>LED2000M-10R</b> | Red    | Clearance Marker | P2  | 0.03     |

For Retail Bag, add the suffix 'P' to the end of the Part No.

|                          |                          |
|--------------------------|--------------------------|
| <b>Grommets</b>          | GR2000 / GR2001          |
| <b>Pigtails</b>          | PT6020 / PT6021 / PT6022 |
| <b>Mounting Brackets</b> | MB2000                   |
| <b>Decorative Bezels</b> | BZ2000 / BZ2000V         |
| <b>Branch Deflectors</b> | BD2000                   |

| AMBER KITS           |  |
|----------------------|--|
| <b>KTL2000M-10A</b>  | Amber • Open Grommet • Single Contact Pigtail                            |
| <b>KTL2001M-10A</b>  | Amber • Closed Grommet • Single Contact Pigtail                          |
| <b>KTLM2001M-10A</b> | Amber • Closed Grommet • Single Contact Pigtail • Steel Mounting Bracket |

| RED KITS             |  |
|----------------------|--|
| <b>KTL2000M-10R</b>  | Red • Open Grommet • Single Contact Pigtail                            |
| <b>KTL2001M-10R</b>  | Red • Closed Grommet • Single Contact Pigtail                          |
| <b>KTLM2001M-10R</b> | Red • Closed Grommet • Single Contact Pigtail • Steel Mounting Bracket |



# 2" ROUND LED LAMPS



## 10 Diode Series

Sealed Polycarbonate Lens & Base • 12V

| Part No.           | Colour | Function         | SAE | Amp Draw |
|--------------------|--------|------------------|-----|----------|
| <b>LED2000-10A</b> | Amber  | Clearance Marker | P2  | 0.03     |
| <b>LED2000-10R</b> | Red    | Clearance Marker | P2  | 0.03     |

### CLEAR LENS LAMPS

|                     |       |                  |    |      |
|---------------------|-------|------------------|----|------|
| <b>LED2000C-10A</b> | Amber | Clearance Marker | P2 | 0.03 |
| <b>LED2000C-10R</b> | Red   | Clearance Marker | P2 | 0.03 |

For Retail Bag, add the suffix 'P' to the end of the Part No.

|                          |                                   |
|--------------------------|-----------------------------------|
| <b>Grommets</b>          | GR2000 / GR2001                   |
| <b>Pigtails</b>          | PT6020 / PT6021 / PT6022          |
| <b>Flange</b>            | FL2000 / FL2001 / FL2002 / FL2005 |
| <b>Mounting Brackets</b> | MB2000                            |
| <b>Decorative Bezels</b> | BZ2000 / BZ2000V                  |
| <b>Branch Deflectors</b> | BD2000                            |



| AMBER KITS           |  |
|----------------------|--|
| <b>LEDF2000-10A0</b> | Amber • White ABS Flange   |
| <b>LEDF2000-10A1</b> | Amber • Black ABS Flange   |
| <b>LEDF2000-10A2</b> | Amber • Gray ABS Flange  |
| <b>LEDF2000-10A5</b> | Amber • Chrome ABS Flange  |
| <b>KTL3201-10A</b>   | Amber • Branch Deflector • Single Contact Pigtail                        |
| <b>KTL2000-10A</b>   | Amber • Open Grommet • Single Contact Pigtail                            |
| <b>KTL2001-10A</b>   | Amber • Closed Grommet • Single Contact Pigtail                          |
| <b>KTLM2001-10A</b>  | Amber • Closed Grommet • Single Contact Pigtail • Steel Mounting Bracket |

| RED KITS             |  |
|----------------------|--|
| <b>LEDF2000-10R0</b> | Red • White ABS Flange   |
| <b>LEDF2000-10R1</b> | Red • Black ABS Flange   |
| <b>LEDF2000-10R2</b> | Red • Gray ABS Flange  |
| <b>LEDF2000-10R5</b> | Red • Chrome ABS Flange  |
| <b>KTL3201-10R</b>   | Red • Branch Deflector • Single Contact Pigtail                        |
| <b>KTL2000-10R</b>   | Red • Open Grommet • Single Contact Pigtail                            |
| <b>KTL2001-10R</b>   | Red • Closed Grommet • Single Contact Pigtail                          |
| <b>KTLM2001-10R</b>  | Red • Closed Grommet • Single Contact Pigtail • Steel Mounting Bracket |

| AMBER KITS - CLEAR LENS |  |
|-------------------------|--|
| <b>LEDF2000-10A0</b>    | Amber • White ABS Flange   |
| <b>LEDF2000-10A1</b>    | Amber • Black ABS Flange   |
| <b>LEDF2000-10A2</b>    | Amber • Gray ABS Flange  |
| <b>LEDF2000-10A5</b>    | Amber • Chrome ABS Flange  |
| <b>KTL3201-10A</b>      | Amber • Branch Deflector • Single Contact Pigtail                        |
| <b>KTL2000-10A</b>      | Amber • Open Grommet • Single Contact Pigtail                            |
| <b>KTL2001-10A</b>      | Amber • Closed Grommet • Single Contact Pigtail                          |
| <b>KTLM2001-10A</b>     | Amber • Closed Grommet • Single Contact Pigtail • Steel Mounting Bracket |

| RED KITS - CLEAR LENS |  |
|-----------------------|--|
| <b>LEDF2000-10R0</b>  | Red • White ABS Flange   |
| <b>LEDF2000-10R1</b>  | Red • Black ABS Flange   |
| <b>LEDF2000-10R2</b>  | Red • Gray ABS Flange  |
| <b>LEDF2000-10R5</b>  | Red • Chrome ABS Flange  |
| <b>KTL3201-10R</b>    | Red • Branch Deflector • Single Contact Pigtail                        |
| <b>KTL2000-10R</b>    | Red • Open Grommet • Single Contact Pigtail                            |
| <b>KTL2001-10R</b>    | Red • Closed Grommet • Single Contact Pigtail                          |
| <b>KTLM2001-10R</b>   | Red • Closed Grommet • Single Contact Pigtail • Steel Mounting Bracket |





# 2" ROUND SPECIALTY LAMPS

CLEARANCE MARKER LAMPS  
FEUX D'ENCOMBREMENT ET DE POSITION

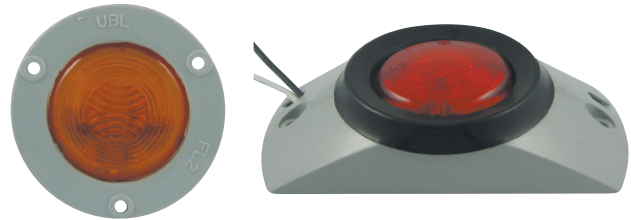
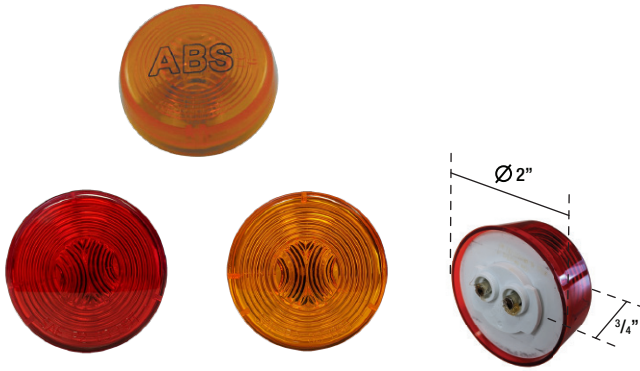

## Incandescent Series

Sealed Polycarbonate Lens & Base • 12V

| Part No.       | Colour | Function         | SAE | Amp Draw |
|----------------|--------|------------------|-----|----------|
| <b>SE2000A</b> | Amber  | Clearance Marker | P2  | 0.33     |
| <b>SE2000R</b> | Red    | Clearance Marker | P2  | 0.33     |

### ABS Brake System Indicator

|                  |       |                                     |
|------------------|-------|-------------------------------------|
| <b>SE2000ABS</b> | Amber | Lens is silk screened with ABS logo |
|------------------|-------|-------------------------------------|

For Retail Bag, add the suffix 'P' to the end of the Part No.

|                          |                                   |
|--------------------------|-----------------------------------|
| <b>Grommets</b>          | GR2000 / GR2001                   |
| <b>Pigtails</b>          | PT6020 / PT6021 / PT6022          |
| <b>Flange</b>            | FL2000 / FL2001 / FL2002 / FL2005 |
| <b>Mounting Brackets</b> | MB2000                            |
| <b>Decorative Bezels</b> | BZ2000 / BZ2000V                  |
| <b>Branch Deflectors</b> | BD2000                            |

| AMBER KITS       |  |
|------------------|--|
| <b>SEF2000A0</b> | Amber • White ABS Flange   |
| <b>SEF2000A1</b> | Amber • Black ABS Flange   |
| <b>SEF2000A2</b> | Amber • Gray ABS Flange  |
| <b>SEF2000A5</b> | Amber • Chrome ABS Flange  |
| <b>KT3200A</b>   | Amber • Branch Deflector • Single Contact Pigtail                        |
| <b>KT3205A</b>   | Amber • Open Grommet • Single Contact Pigtail                            |
| <b>KT3215A</b>   | Amber • Closed Grommet • Single Contact Pigtail                          |
| <b>KTM2001A</b>  | Amber • Closed Grommet • Single Contact Pigtail • Steel Mounting Bracket |

| RED KITS         |  |
|------------------|--|
| <b>SEF2000R0</b> | Red • White ABS Flange   |
| <b>SEF2000R1</b> | Red • Black ABS Flange   |
| <b>SEF2000R2</b> | Red • Gray ABS Flange  |
| <b>SEF2000R5</b> | Red • Chrome ABS Flange  |
| <b>KT3200R</b>   | Red • Branch Deflector • Single Contact Pigtail                        |
| <b>KT3205R</b>   | Red • Open Grommet • Single Contact Pigtail                            |
| <b>KT3215R</b>   | Red • Closed Grommet • Single Contact Pigtail                          |
| <b>KTM2001R</b>  | Red • Closed Grommet • Single Contact Pigtail • Steel Mounting Bracket |

# 2.5" ROUND LED LAMPS

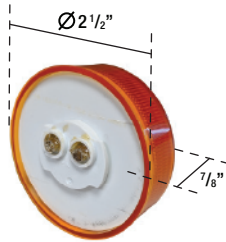

## 1 Diode Series

Sealed Polycarbonate Lens & Base • 12V

| Part No.          | Colour | Function         | SAE | Amp Draw |
|-------------------|--------|------------------|-----|----------|
| <b>LED2510-1A</b> | Amber  | Clearance Marker | PC  | 0.04     |
| <b>LED2510-1R</b> | Red    | Clearance Marker | PC  | 0.04     |

For Retail Bag, add the suffix 'P' to the end of the Part No.

|                          |                                   |
|--------------------------|-----------------------------------|
| <b>Grommets</b>          | GR2500 / GR2501                   |
| <b>Pigtails</b>          | PT6020 / PT6021 / PT6022          |
| <b>Flange</b>            | FL2500 / FL2501 / FL2502 / FL2505 |
| <b>Mounting Brackets</b> | MB2500                            |
| <b>Decorative Bezels</b> | BZ2500 / BZ2500V                  |
| <b>Branch Deflectors</b> | BD2500                            |

| AMBER KITS         |  |
|--------------------|--|
| <b>KTL2510-1A</b>  | Amber • Open Grommet • Single Contact Pigtail                            |
| <b>KTL2511-1A</b>  | Amber • Closed Grommet • Single Contact Pigtail                          |
| <b>KTLM2511-1A</b> | Amber • Closed Grommet • Single Contact Pigtail • Steel Mounting Bracket |

| RED KITS           |  |
|--------------------|--|
| <b>KTL2510-1R</b>  | Red • Open Grommet • Single Contact Pigtail                            |
| <b>KTL2511-1R</b>  | Red • Closed Grommet • Single Contact Pigtail                          |
| <b>KTLM2511-1R</b> | Red • Closed Grommet • Single Contact Pigtail • Steel Mounting Bracket |

## 8-Gang RGB Switch Kit all hardware required (included)



| Part No.     | Voltage       | Material |
|--------------|---------------|----------|
| <b>SG800</b> | 12V to 24V DC | Aluminum |

- Operating temp: -40°C to 85°C
- 11 RGB Colours to choose from
- Adjustable backlight brightness
- Built-in Memory Function

CE    FCC    RoHS



**Built-In Switch Modes: CONSTANT / MOMENTARY / FLASH / STROBE**

# 2.5" ROUND LAMPS

CLEARANCE MARKER LAMPS  
FEUX D'ENCOMBREMENT ET DE POSITION

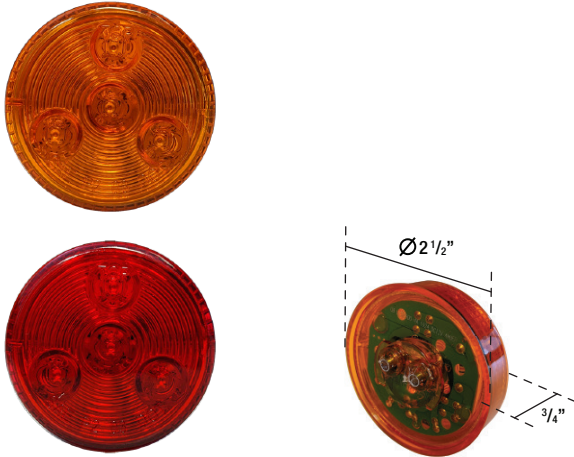

## 4 Diode Series

Sealed Polycarbonate Lens & Base • 12V

| Part No.          | Colour | Function         | SAE | Amp Draw |
|-------------------|--------|------------------|-----|----------|
| <b>LED2500-4A</b> | Amber  | Clearance Marker | P2  | 0.06     |
| <b>LED2500-4R</b> | Red    | Clearance Marker | P2  | 0.06     |

### REFLECTIVE LENS LAMPS

|                  |       |                  |     |      |
|------------------|-------|------------------|-----|------|
| <b>LR2500-4A</b> | Amber | Clearance Marker | AP2 | 0.06 |
| <b>LR2500-4R</b> | Red   | Clearance Marker | AP2 | 0.06 |

For Retail Bag, add the suffix 'P' to the end of the Part No.

|                          |                                   |
|--------------------------|-----------------------------------|
| <b>Grommets</b>          | GR2500 / GR2501                   |
| <b>Pigtails</b>          | PT6020 / PT6021 / PT6022          |
| <b>Flange</b>            | FL2500 / FL2501 / FL2502 / FL2505 |
| <b>Mounting Brackets</b> | MB2500                            |
| <b>Decorative Bezels</b> | BZ2500 / BZ2500V                  |
| <b>Branch Deflectors</b> | BD2500                            |

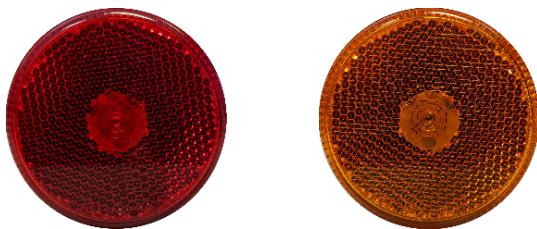

| AMBER KITS          |  |
|---------------------|--|
| <b>LEDF2500-4A0</b> | Amber • White ABS Flange   |
| <b>LEDF2500-4A1</b> | Amber • Black ABS Flange   |
| <b>LEDF2500-4A2</b> | Amber • Gray ABS Flange  |
| <b>LEDF2500-4A5</b> | Amber • Chrome ABS Flange  |
| <b>KTL3251-4A</b>   | Amber • Branch Deflector • Single Contact Pigtail                        |
| <b>KTL2500-4A</b>   | Amber • Open Grommet • Single Contact Pigtail                            |
| <b>KTL2501-4A</b>   | Amber • Closed Grommet • Single Contact Pigtail                          |
| <b>KTLM2501-4A</b>  | Amber • Closed Grommet • Single Contact Pigtail • Steel Mounting Bracket |

| RED KITS            |  |
|---------------------|--|
| <b>LEDF2500-4R0</b> | Red • White ABS Flange   |
| <b>LEDF2500-4R1</b> | Red • Black ABS Flange   |
| <b>LEDF2500-4R2</b> | Red • Gray ABS Flange  |
| <b>LEDF2500-4R5</b> | Red • Chrome ABS Flange  |
| <b>KTL3251-4R</b>   | Red • Branch Deflector • Single Contact Pigtail                        |
| <b>KTL2500-4R</b>   | Red • Open Grommet • Single Contact Pigtail                            |
| <b>KTL2501-4R</b>   | Red • Closed Grommet • Single Contact Pigtail                          |
| <b>KTLM2501-4R</b>  | Red • Closed Grommet • Single Contact Pigtail • Steel Mounting Bracket |

| AMBER KITS - REFLECTIVE LENS |  |
|------------------------------|--|
| <b>LRF2500-4A0</b>           | Amber • White ABS Flange   |
| <b>LRF2500-4A1</b>           | Amber • Black ABS Flange   |
| <b>LRF2500-4A2</b>           | Amber • Gray ABS Flange  |
| <b>LRF2500-4A5</b>           | Amber • Chrome ABS Flange  |
| <b>KTRL3251-4A</b>           | Amber • Branch Deflector • Single Contact Pigtail                        |
| <b>KTRL2500-4A</b>           | Amber • Open Grommet • Single Contact Pigtail                            |
| <b>KTRL2501-4A</b>           | Amber • Closed Grommet • Single Contact Pigtail                          |
| <b>KTRLM2501-4A</b>          | Amber • Closed Grommet • Single Contact Pigtail • Steel Mounting Bracket |

| RED KITS - REFLECTIVE LENS |  |
|----------------------------|--|
| <b>LRF2500-4R0</b>         | Red • White ABS Flange   |
| <b>LRF2500-4R1</b>         | Red • Black ABS Flange   |
| <b>LRF2500-4R2</b>         | Red • Gray ABS Flange  |
| <b>LRF2500-4R5</b>         | Red • Chrome ABS Flange  |
| <b>KTRL3251-4R</b>         | Red • Branch Deflector • Single Contact Pigtail                        |
| <b>KTRL2500-4R</b>         | Red • Open Grommet • Single Contact Pigtail                            |
| <b>KTRL2501-4R</b>         | Red • Closed Grommet • Single Contact Pigtail                          |
| <b>KTRLM2501-4R</b>        | Red • Closed Grommet • Single Contact Pigtail • Steel Mounting Bracket |

# 2.5" ROUND LED LAMPS

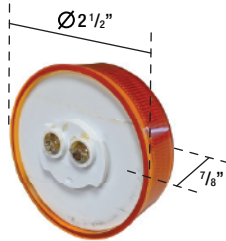

## 6 Diode Series

Sealed Polycarbonate Lens & Base • 12V

| Part No.          | Colour | Function         | SAE | Amp Draw |
|-------------------|--------|------------------|-----|----------|
| <b>LED2500-6A</b> | Amber  | Clearance Marker | P2  | 0.04     |
| <b>LED2500-6R</b> | Red    | Clearance Marker | P2  | 0.06     |

### CLEAR LENS LAMPS

|                    |       |                  |    |      |
|--------------------|-------|------------------|----|------|
| <b>LED2500C-6A</b> | Amber | Clearance Marker | P2 | 0.04 |
| <b>LED2500C-6R</b> | Red   | Clearance Marker | P2 | 0.06 |

For Retail Bag, add the suffix 'P' to the end of the Part No.

|                          |                                   |
|--------------------------|-----------------------------------|
| <b>Grommets</b>          | GR2500 / GR2501                   |
| <b>Pigtails</b>          | PT6020 / PT6021 / PT6022          |
| <b>Flange</b>            | FL2500 / FL2501 / FL2502 / FL2505 |
| <b>Mounting Brackets</b> | MB2500                            |
| <b>Decorative Bezels</b> | BZ2500 / BZ2500V                  |
| <b>Branch Deflectors</b> | BD2500                            |

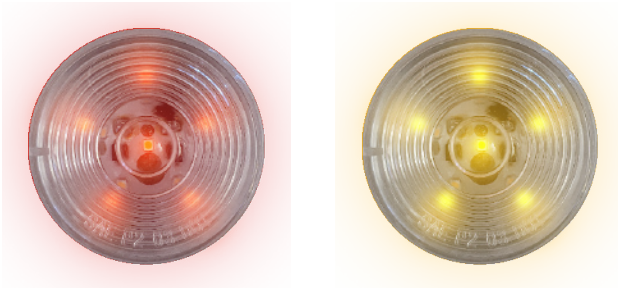

| AMBER KITS          |  |
|---------------------|--|
| <b>LEDF2500-6A0</b> | Amber • White ABS Flange   |
| <b>LEDF2500-6A1</b> | Amber • Black ABS Flange   |
| <b>LEDF2500-6A2</b> | Amber • Gray ABS Flange  |
| <b>LEDF2500-6A5</b> | Amber • Chrome ABS Flange  |
| <b>KTL3251-6A</b>   | Amber • Branch Deflector • Single Contact Pigtail                        |
| <b>KTL2500-6A</b>   | Amber • Open Grommet • Single Contact Pigtail                            |
| <b>KTL2501-6A</b>   | Amber • Closed Grommet • Single Contact Pigtail                          |
| <b>KTLM2501-6A</b>  | Amber • Closed Grommet • Single Contact Pigtail • Steel Mounting Bracket |

| RED KITS            |  |
|---------------------|--|
| <b>LEDF2500-6R0</b> | Red • White ABS Flange   |
| <b>LEDF2500-6R1</b> | Red • Black ABS Flange   |
| <b>LEDF2500-6R2</b> | Red • Gray ABS Flange  |
| <b>LEDF2500-6R5</b> | Red • Chrome ABS Flange  |
| <b>KTL3251-6R</b>   | Red • Branch Deflector • Single Contact Pigtail                        |
| <b>KTL2500-6R</b>   | Red • Open Grommet • Single Contact Pigtail                            |
| <b>KTL2501-6R</b>   | Red • Closed Grommet • Single Contact Pigtail                          |
| <b>KTLM2501-6R</b>  | Red • Closed Grommet • Single Contact Pigtail • Steel Mounting Bracket |

| AMBER KITS - CLEAR LENS |  |
|-------------------------|--|
| <b>LEDF2500C-6A0</b>    | Amber • White ABS Flange   |
| <b>LEDF2500C-6A1</b>    | Amber • Black ABS Flange   |
| <b>LEDF2500C-6A2</b>    | Amber • Gray ABS Flange  |
| <b>LEDF2500C-6A5</b>    | Amber • Chrome ABS Flange  |
| <b>KTL3251C-6A</b>      | Amber • Branch Deflector • Single Contact Pigtail                        |
| <b>KTL2500C-6A</b>      | Amber • Open Grommet • Single Contact Pigtail                            |
| <b>KTL2501C-6A</b>      | Amber • Closed Grommet • Single Contact Pigtail                          |
| <b>KTLM2501C-6A</b>     | Amber • Closed Grommet • Single Contact Pigtail • Steel Mounting Bracket |

| RED KITS - CLEAR LENS |  |
|-----------------------|--|
| <b>LEDF2500C-6R0</b>  | Red • White ABS Flange   |
| <b>LEDF2500C-6R1</b>  | Red • Black ABS Flange   |
| <b>LEDF2500C-6R2</b>  | Red • Gray ABS Flange  |
| <b>LEDF2500C-6R5</b>  | Red • Chrome ABS Flange  |
| <b>KTL3251C-6R</b>    | Red • Branch Deflector • Single Contact Pigtail                        |
| <b>KTL2500C-6R</b>    | Red • Open Grommet • Single Contact Pigtail                            |
| <b>KTL2501C-6R</b>    | Red • Closed Grommet • Single Contact Pigtail                          |
| <b>KTLM2501C-6R</b>   | Red • Closed Grommet • Single Contact Pigtail • Steel Mounting Bracket |

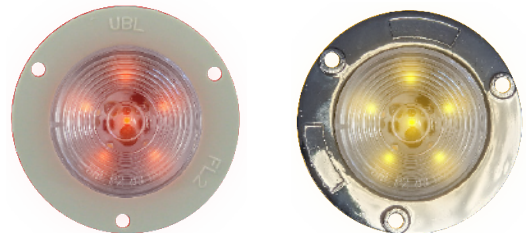



# 2.5" ROUND LAMPS

CLEARANCE MARKER LAMPS  
FEUX D'ENCOMBREMENT ET DE POSITION

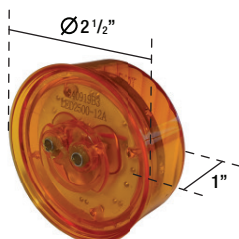

## 12 Diode Series

Sealed Polycarbonate Lens & Base • 12V

| Part No.           | Colour | Function         | SAE  | Amp Draw |
|--------------------|--------|------------------|------|----------|
| <b>LED2500-12A</b> | Amber  | Clearance Marker | P2P3 | 0.03     |
| <b>LED2500-12R</b> | Red    | Clearance Marker | P2P3 | 0.03     |

For Retail Bag, add the suffix 'P' to the end of the Part No.

|                          |                                   |
|--------------------------|-----------------------------------|
| <b>Grommets</b>          | GR2500 / GR2501                   |
| <b>Pigtails</b>          | PT6020 / PT6021 / PT6022          |
| <b>Flange</b>            | FL2500 / FL2501 / FL2502 / FL2505 |
| <b>Mounting Brackets</b> | MB2500                            |
| <b>Decorative Bezels</b> | BZ2500 / BZ2500V                  |
| <b>Branch Deflectors</b> | BD2500                            |



| AMBER KITS           |  |
|----------------------|--|
| <b>LEDF2500-12A0</b> | Amber • White ABS Flange   |
| <b>LEDF2500-12A1</b> | Amber • Black ABS Flange   |
| <b>LEDF2500-12A2</b> | Amber • Gray ABS Flange  |
| <b>LEDF2500-12A5</b> | Amber • Chrome ABS Flange  |
| <b>KTL3251-12A</b>   | Amber • Branch Deflector • Single Contact Pigtail                        |
| <b>KTL2500-12A</b>   | Amber • Open Grommet • Single Contact Pigtail                            |
| <b>KTL2501-12A</b>   | Amber • Closed Grommet • Single Contact Pigtail                          |
| <b>KTLM2501-12A</b>  | Amber • Closed Grommet • Single Contact Pigtail • Steel Mounting Bracket |

| RED KITS             |  |
|----------------------|--|
| <b>LEDF2500-12R0</b> | Red • White ABS Flange   |
| <b>LEDF2500-12R1</b> | Red • Black ABS Flange   |
| <b>LEDF2500-12R2</b> | Red • Gray ABS Flange  |
| <b>LEDF2500-12R5</b> | Red • Chrome ABS Flange  |
| <b>KTL3251-12R</b>   | Red • Branch Deflector • Single Contact Pigtail                        |
| <b>KTL2500-12R</b>   | Red • Open Grommet • Single Contact Pigtail                            |
| <b>KTL2501-12R</b>   | Red • Closed Grommet • Single Contact Pigtail                          |
| <b>KTLM2501-12R</b>  | Red • Closed Grommet • Single Contact Pigtail • Steel Mounting Bracket |

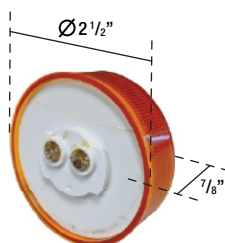

## 13 Diode (Multi-Voltage) Series

Sealed Polycarbonate Lens & Base

**MULTI-VOLTAGE**  
**12V - 24V**

| Part No.            | Colour | Function         | SAE | Amp Draw |
|---------------------|--------|------------------|-----|----------|
| <b>LED2500M-13A</b> | Amber  | Clearance Marker | P2  | 0.07     |
| <b>LED2500M-13R</b> | Red    | Clearance Marker | P2  | 0.07     |

For Retail Bag, add the suffix 'P' to the end of the Part No.

|                          |                          |
|--------------------------|--------------------------|
| <b>Grommets</b>          | GR2500 / GR2501          |
| <b>Pigtails</b>          | PT6020 / PT6021 / PT6022 |
| <b>Mounting Brackets</b> | MB2500                   |
| <b>Decorative Bezels</b> | BZ2500 / BZ2500V         |
| <b>Branch Deflectors</b> | BD2500                   |



| AMBER KITS           |  |
|----------------------|--|
| <b>KTL2500M-13A</b>  | Amber • Open Grommet • Single Contact Pigtail                            |
| <b>KTL2501M-13A</b>  | Amber • Closed Grommet • Single Contact Pigtail                          |
| <b>KTLM2501M-13A</b> | Amber • Closed Grommet • Single Contact Pigtail • Steel Mounting Bracket |

| RED KITS             |  |
|----------------------|--|
| <b>KTL2500M-13R</b>  | Red • Open Grommet • Single Contact Pigtail                            |
| <b>KTL2501M-13R</b>  | Red • Closed Grommet • Single Contact Pigtail                          |
| <b>KTLM2501M-13R</b> | Red • Closed Grommet • Single Contact Pigtail • Steel Mounting Bracket |



# 2.5" ROUND LED LAMPS

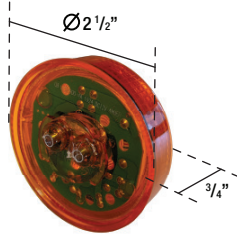

## 13 Diode Series

Sealed Polycarbonate Lens & Base • 12V

| Part No.           | Colour | Function         | SAE | Amp Draw |
|--------------------|--------|------------------|-----|----------|
| <b>LED2500-13A</b> | Amber  | Clearance Marker | P2  | 0.07     |
| <b>LED2500-13R</b> | Red    | Clearance Marker | P2  | 0.07     |

### CLEAR LENS LAMPS

|                     |       |                  |    |      |
|---------------------|-------|------------------|----|------|
| <b>LED2500C-13A</b> | Amber | Clearance Marker | P2 | 0.07 |
| <b>LED2500C-13R</b> | Red   | Clearance Marker | P2 | 0.07 |

For Retail Bag, add the suffix 'P' to the end of the Part No.

|                          |                                   |
|--------------------------|-----------------------------------|
| <b>Grommets</b>          | GR2500 / GR2501                   |
| <b>Pigtails</b>          | PT6020 / PT6021 / PT6022          |
| <b>Flange</b>            | FL2500 / FL2501 / FL2502 / FL2505 |
| <b>Mounting Brackets</b> | MB2500                            |
| <b>Decorative Bezels</b> | BZ2500 / BZ2500V                  |
| <b>Branch Deflectors</b> | BD2500                            |

| AMBER KITS           |  |
|----------------------|--|
| <b>LEDF2500-13A0</b> | Amber • White ABS Flange   |
| <b>LEDF2500-13A1</b> | Amber • Black ABS Flange   |
| <b>LEDF2500-13A2</b> | Amber • Gray ABS Flange  |
| <b>LEDF2500-13A5</b> | Amber • Chrome ABS Flange  |
| <b>KTL3251-13A</b>   | Amber • Branch Deflector • Single Contact Pigtail                        |
| <b>KTL2500-13A</b>   | Amber • Open Grommet • Single Contact Pigtail                            |
| <b>KTL2501-13A</b>   | Amber • Closed Grommet • Single Contact Pigtail                          |
| <b>KTLM2501-13A</b>  | Amber • Closed Grommet • Single Contact Pigtail • Steel Mounting Bracket |

| RED KITS             |  |
|----------------------|--|
| <b>LEDF2500-13R0</b> | Red • White ABS Flange   |
| <b>LEDF2500-13R1</b> | Red • Black ABS Flange   |
| <b>LEDF2500-13R2</b> | Red • Gray ABS Flange  |
| <b>LEDF2500-13R5</b> | Red • Chrome ABS Flange  |
| <b>KTL3251-13R</b>   | Red • Branch Deflector • Single Contact Pigtail                        |
| <b>KTL2500-13R</b>   | Red • Open Grommet • Single Contact Pigtail                            |
| <b>KTL2501-13R</b>   | Red • Closed Grommet • Single Contact Pigtail                          |
| <b>KTLM2501-13R</b>  | Red • Closed Grommet • Single Contact Pigtail • Steel Mounting Bracket |

| AMBER KITS - CLEAR LENS |  |
|-------------------------|--|
| <b>LEDF2500C-13A0</b>   | Amber • White ABS Flange   |
| <b>LEDF2500C-13A1</b>   | Amber • Black ABS Flange   |
| <b>LEDF2500C-13A2</b>   | Amber • Gray ABS Flange  |
| <b>LEDF2500C-13A5</b>   | Amber • Chrome ABS Flange  |
| <b>KTL3251C-13A</b>     | Amber • Branch Deflector • Single Contact Pigtail                        |
| <b>KTL2500C-13A</b>     | Amber • Open Grommet • Single Contact Pigtail                            |
| <b>KTL2501C-13A</b>     | Amber • Closed Grommet • Single Contact Pigtail                          |
| <b>KTLM2501C-13A</b>    | Amber • Closed Grommet • Single Contact Pigtail • Steel Mounting Bracket |

| RED KITS - CLEAR LENS |  |
|-----------------------|--|
| <b>LEDF2500C-13R0</b> | Red • White ABS Flange   |
| <b>LEDF2500C-13R1</b> | Red • Black ABS Flange   |
| <b>LEDF2500C-13R2</b> | Red • Gray ABS Flange  |
| <b>LEDF2500C-13R5</b> | Red • Chrome ABS Flange  |
| <b>KTL3251C-13R</b>   | Red • Branch Deflector • Single Contact Pigtail                        |
| <b>KTL2500C-13R</b>   | Red • Open Grommet • Single Contact Pigtail                            |
| <b>KTL2501C-13R</b>   | Red • Closed Grommet • Single Contact Pigtail                          |
| <b>KTLM2501C-13R</b>  | Red • Closed Grommet • Single Contact Pigtail • Steel Mounting Bracket |



# 2.5" ROUND SPECIALTY LAMPS

CLEARANCE MARKER LAMPS  
FEUX D'ENCOMBREMENT ET DE POSITION

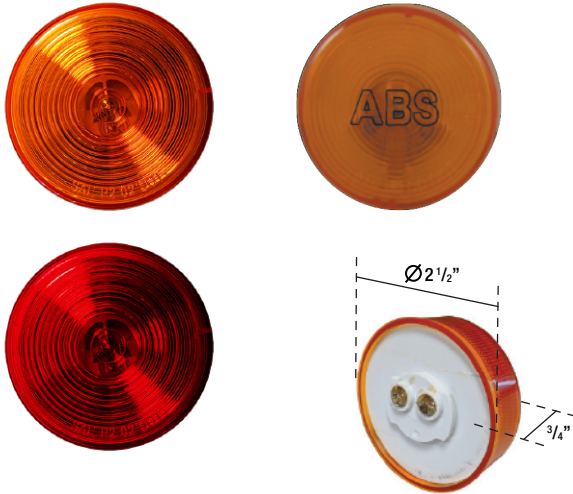

## Incandescent Series

Sealed Polycarbonate Lens & Base • 12V

| Part No.       | Colour | Function         | SAE | Amp Draw |
|----------------|--------|------------------|-----|----------|
| <b>SE2500A</b> | Amber  | Clearance Marker | P2  | 0.33     |
| <b>SE2500R</b> | Red    | Clearance Marker | P2  | 0.33     |

### REFLECTIVE LENS LAMPS

|                |       |                  |     |      |
|----------------|-------|------------------|-----|------|
| <b>SR2500A</b> | Amber | Clearance Marker | AP2 | 0.33 |
| <b>SR2500R</b> | Red   | Clearance Marker | AP2 | 0.33 |

### ABS Brake System Indicator

|                  |       |                                     |
|------------------|-------|-------------------------------------|
| <b>SE2500ABS</b> | Amber | Lens is silk screened with ABS logo |
|------------------|-------|-------------------------------------|

For Retail Bag, add the suffix 'P' to the end of the Part No.

|                   |                                   |
|-------------------|-----------------------------------|
| Grommets          | GR2500 / GR2501                   |
| Pigtails          | PT6020 / PT6021 / PT6022          |
| Flange            | FL2500 / FL2501 / FL2502 / FL2505 |
| Mounting Brackets | MB2500                            |
| Decorative Bezels | BZ2500 / BZ2500V                  |
| Branch Deflectors | BD2500                            |

| AMBER KITS       |  |
|------------------|--|
| <b>SEF2500A0</b> | Amber • White ABS Flange   |
| <b>SEF2500A1</b> | Amber • Black ABS Flange   |
| <b>SEF2500A2</b> | Amber • Gray ABS Flange  |
| <b>SEF2500A5</b> | Amber • Chrome ABS Flange  |
| <b>KT3250A</b>   | Amber • Branch Deflector • Single Contact Pigtail                        |
| <b>KT3255A</b>   | Amber • Open Grommet • Single Contact Pigtail                            |
| <b>KT3256A</b>   | Amber • Closed Grommet • Single Contact Pigtail                          |
| <b>KTM2501A</b>  | Amber • Closed Grommet • Single Contact Pigtail • Steel Mounting Bracket |

| RED KITS         |  |
|------------------|--|
| <b>SEF2500R0</b> | Red • White ABS Flange   |
| <b>SEF2500R1</b> | Red • Black ABS Flange   |
| <b>SEF2500R2</b> | Red • Gray ABS Flange  |
| <b>SEF2500R5</b> | Red • Chrome ABS Flange  |
| <b>KT3250R</b>   | Red • Branch Deflector • Single Contact Pigtail                        |
| <b>KT3255R</b>   | Red • Open Grommet • Single Contact Pigtail                            |
| <b>KT3256R</b>   | Red • Closed Grommet • Single Contact Pigtail                          |
| <b>KTM2501R</b>  | Red • Closed Grommet • Single Contact Pigtail • Steel Mounting Bracket |

| AMBER KITS - REFLECTIVE LENS |  |
|------------------------------|--|
| <b>SRF2500A0</b>             | Amber • White ABS Flange   |
| <b>SRF2500A1</b>             | Amber • Black ABS Flange   |
| <b>SRF2500A2</b>             | Amber • Gray ABS Flange  |
| <b>SRF2500A5</b>             | Amber • Chrome ABS Flange  |
| <b>KTR3250A</b>              | Amber • Branch Deflector • Single Contact Pigtail                        |
| <b>KTR5250A</b>              | Amber • Open Grommet • Single Contact Pigtail                            |
| <b>KTR5251A</b>              | Amber • Closed Grommet • Single Contact Pigtail                          |
| <b>KTMR2501A</b>             | Amber • Closed Grommet • Single Contact Pigtail • Steel Mounting Bracket |

| RED KITS - REFLECTIVE LENS |  |
|----------------------------|--|
| <b>SRF2500R0</b>           | Red • White ABS Flange   |
| <b>SRF2500R1</b>           | Red • Black ABS Flange   |
| <b>SRF2500R2</b>           | Red • Gray ABS Flange  |
| <b>SRF2500R5</b>           | Red • Chrome ABS Flange  |
| <b>KTR3250R</b>            | Red • Branch Deflector • Single Contact Pigtail                        |
| <b>KTR5250R</b>            | Red • Open Grommet • Single Contact Pigtail                            |
| <b>KTR5251R</b>            | Red • Closed Grommet • Single Contact Pigtail                          |
| <b>KTMR2501R</b>           | Red • Closed Grommet • Single Contact Pigtail • Steel Mounting Bracket |



# 2" BEEHIVE LED LAMPS

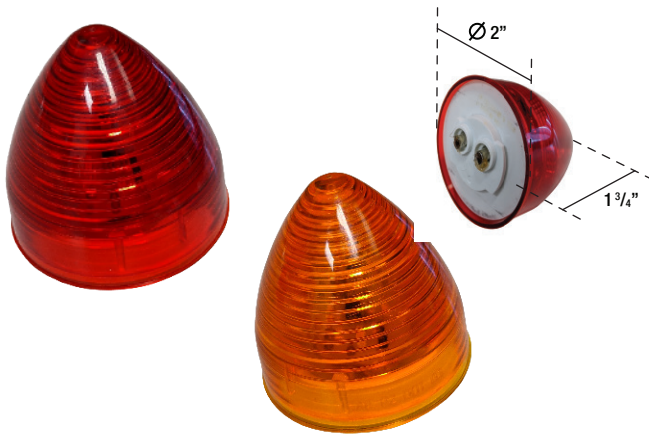

## 6 Diode Series

Sealed Polycarbonate Lens & Base • 12V

| Part No.          | Colour | Function         | SAE | Amp Draw |
|-------------------|--------|------------------|-----|----------|
| <b>LED7200-6A</b> | Amber  | Clearance Marker | P2  | 0.03     |
| <b>LED7200-6R</b> | Red    | Clearance Marker | P2  | 0.03     |

For Retail Bag, add the suffix 'P' to the end of the Part No.

|                          |                                   |
|--------------------------|-----------------------------------|
| <b>Grommets</b>          | GR2000 / GR2001                   |
| <b>Pigtails</b>          | PT6020 / PT6021 / PT6022          |
| <b>Flange</b>            | FL2000 / FL2001 / FL2002 / FL2005 |
| <b>Decorative Bezels</b> | BZ2000 / BZ2000V                  |

| AMBER KITS          |   |
|---------------------|---|
| <b>LEDF7200-6A0</b> | Amber • White ABS Flange                        |
| <b>LEDF7200-6A1</b> | Amber • Black ABS Flange                        |
| <b>LEDF7200-6A2</b> | Amber • Gray ABS Flange                         |
| <b>LEDF7200-6A5</b> | Amber • Chrome ABS Flange                       |
| <b>KTL7200-6A</b>   | Amber • Open Grommet • Single Contact Pigtail   |
| <b>KTL7201-6A</b>   | Amber • Closed Grommet • Single Contact Pigtail |

| RED KITS            |   |
|---------------------|---|
| <b>LEDF7200-6R0</b> | Red • White ABS Flange                        |
| <b>LEDF7200-6R1</b> | Red • Black ABS Flange                        |
| <b>LEDF7200-6R2</b> | Red • Gray ABS Flange                         |
| <b>LEDF7200-6R5</b> | Red • Chrome ABS Flange                       |
| <b>KTL7200-6R</b>   | Red • Open Grommet • Single Contact Pigtail   |
| <b>KTL7201-6R</b>   | Red • Closed Grommet • Single Contact Pigtail |



## 10 Diode Series

Sealed Polycarbonate Lens & Base • 12V

| Part No.           | Colour | Function         | SAE | Amp Draw |
|--------------------|--------|------------------|-----|----------|
| <b>LED7200-10A</b> | Amber  | Clearance Marker | P2  | 0.06     |
| <b>LED7200-10R</b> | Red    | Clearance Marker | P2  | 0.06     |

For Retail Bag, add the suffix 'P' to the end of the Part No.

|                          |                                   |
|--------------------------|-----------------------------------|
| <b>Grommets</b>          | GR2000 / GR2001                   |
| <b>Pigtails</b>          | PT6020 / PT6021 / PT6022          |
| <b>Flange</b>            | FL2000 / FL2001 / FL2002 / FL2005 |
| <b>Decorative Bezels</b> | BZ2000 / BZ2000V                  |

| AMBER KITS           |   |
|----------------------|---|
| <b>LEDF7200-10A0</b> | Amber • White ABS Flange                        |
| <b>LEDF7200-10A1</b> | Amber • Black ABS Flange                        |
| <b>LEDF7200-10A2</b> | Amber • Gray ABS Flange                         |
| <b>LEDF7200-10A5</b> | Amber • Chrome ABS Flange                       |
| <b>KTL7200-10A</b>   | Amber • Open Grommet • Single Contact Pigtail   |
| <b>KTL7201-10A</b>   | Amber • Closed Grommet • Single Contact Pigtail |

| RED KITS             |   |
|----------------------|---|
| <b>LEDF7200-10R0</b> | Red • White ABS Flange                        |
| <b>LEDF7200-10R1</b> | Red • Black ABS Flange                        |
| <b>LEDF7200-10R2</b> | Red • Gray ABS Flange                         |
| <b>LEDF7200-10R5</b> | Red • Chrome ABS Flange                       |
| <b>KTL7200-10R</b>   | Red • Open Grommet • Single Contact Pigtail   |
| <b>KTL7201-10R</b>   | Red • Closed Grommet • Single Contact Pigtail |

# 2.5" BEEHIVE LED LAMPS

CLEARANCE MARKER LAMPS  
FEUX D'ENCOMBREMENT ET DE POSITION

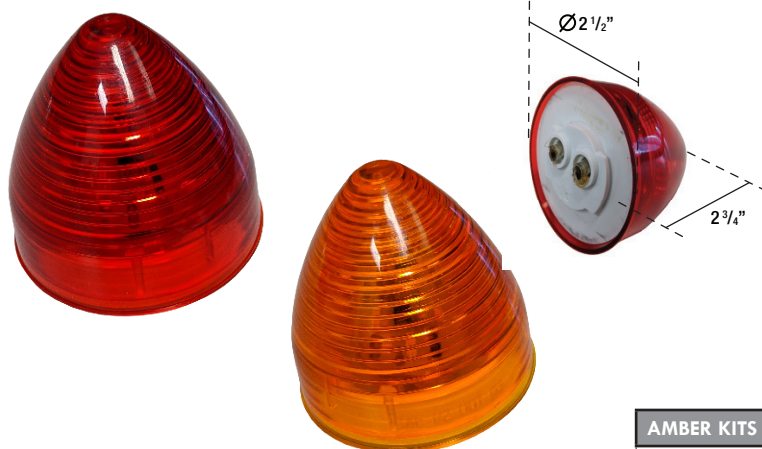

## 6 Diode Series

Sealed Polycarbonate Lens & Base • 12V

| Part No.          | Colour | Function         | SAE | Amp Draw |
|-------------------|--------|------------------|-----|----------|
| <b>LED7250-6A</b> | Amber  | Clearance Marker | P2  | 0.03     |
| <b>LED7250-6R</b> | Red    | Clearance Marker | P2  | 0.03     |

For Retail Bag, add the suffix 'P' to the end of the Part No.

|                          |                                   |
|--------------------------|-----------------------------------|
| <b>Grommets</b>          | GR2500 / GR2501                   |
| <b>Pigtails</b>          | PT6020 / PT6021 / PT6022          |
| <b>Flange</b>            | FL2500 / FL2501 / FL2502 / FL2505 |
| <b>Decorative Bezels</b> | BZ2500 / BZ2500U                  |

| AMBER KITS          |   |
|---------------------|---|
| <b>LEDF7250-6A0</b> | Amber • White ABS Flange                        |
| <b>LEDF7250-6A1</b> | Amber • Black ABS Flange                        |
| <b>LEDF7250-6A2</b> | Amber • Gray ABS Flange                         |
| <b>LEDF7250-6A5</b> | Amber • Chrome ABS Flange                       |
| <b>KTL7250-6A</b>   | Amber • Open Grommet • Single Contact Pigtail   |
| <b>KTL7251-6A</b>   | Amber • Closed Grommet • Single Contact Pigtail |

| RED KITS            |   |
|---------------------|---|
| <b>LEDF7250-6R0</b> | Red • White ABS Flange                        |
| <b>LEDF7250-6R1</b> | Red • Black ABS Flange                        |
| <b>LEDF7250-6R2</b> | Red • Gray ABS Flange                         |
| <b>LEDF7250-6R5</b> | Red • Chrome ABS Flange                       |
| <b>KTL7250-6R</b>   | Red • Open Grommet • Single Contact Pigtail   |
| <b>KTL7251-6R</b>   | Red • Closed Grommet • Single Contact Pigtail |



## 13 Diode Series

Sealed Polycarbonate Lens & Base • 12V

| Part No.        | Colour | Function         | SAE | Amp Draw |
|-----------------|--------|------------------|-----|----------|
| <b>LED7250A</b> | Amber  | Clearance Marker | P2  | 0.08     |
| <b>LED7250R</b> | Red    | Clearance Marker | P2  | 0.08     |

For Retail Bag, add the suffix 'P' to the end of the Part No.

|                          |                                   |
|--------------------------|-----------------------------------|
| <b>Grommets</b>          | GR2500 / GR2501                   |
| <b>Pigtails</b>          | PT6020 / PT6021 / PT6022          |
| <b>Flange</b>            | FL2500 / FL2501 / FL2502 / FL2505 |
| <b>Decorative Bezels</b> | BZ2500 / BZ2500U                  |

| AMBER KITS        |   |
|-------------------|---|
| <b>LEDF7250A0</b> | Amber • White ABS Flange                        |
| <b>LEDF7250A1</b> | Amber • Black ABS Flange                        |
| <b>LEDF7250A2</b> | Amber • Gray ABS Flange                         |
| <b>LEDF7250A5</b> | Amber • Chrome ABS Flange                       |
| <b>KTL7250A</b>   | Amber • Open Grommet • Single Contact Pigtail   |
| <b>KTL7251A</b>   | Amber • Closed Grommet • Single Contact Pigtail |

| RED KITS          |   |
|-------------------|---|
| <b>LEDF7250R0</b> | Red • White ABS Flange                        |
| <b>LEDF7250R1</b> | Red • Black ABS Flange                        |
| <b>LEDF7250R2</b> | Red • Gray ABS Flange                         |
| <b>LEDF7250R5</b> | Red • Chrome ABS Flange                       |
| <b>KTL7250R</b>   | Red • Open Grommet • Single Contact Pigtail   |
| <b>KTL7251R</b>   | Red • Closed Grommet • Single Contact Pigtail |



# LIGHT BAR CLEARANCE MARKERS

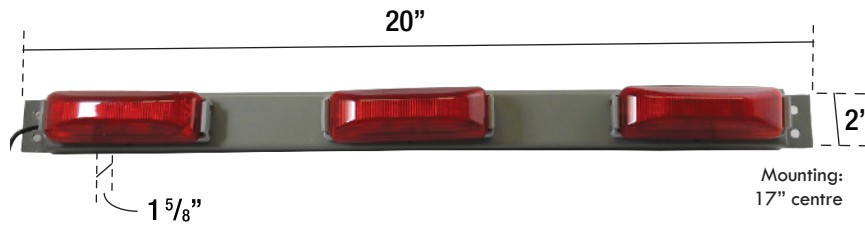

## 20" LED Clearance Marker Bar

LED: (3x) 4-Diode Red 4" Rectangular Lamps on Grey Steel Bar • 12V

| Part No.          | Colour | Function         | SAE | Amp Draw |
|-------------------|--------|------------------|-----|----------|
| <b>LBL1042-4R</b> | Red    | Clearance Marker | P2  | 0.06     |

For Retail Bag, add the suffix 'P' to the end of the Part No.

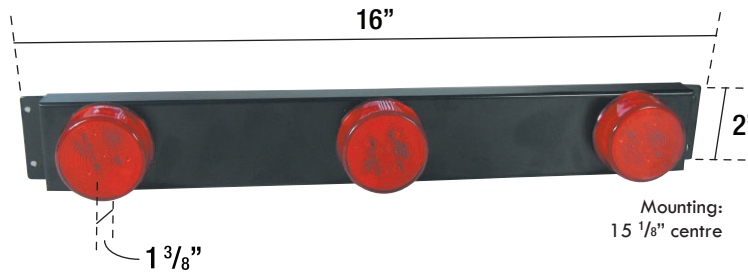

## 16" LED Clearance Marker Bar

LED: (3x) 4-Diode Red 2" Round Lamps on Black Steel Bar • 12V

| Part No.        | Colour | Function         | SAE | Amp Draw |
|-----------------|--------|------------------|-----|----------|
| <b>LBL2000R</b> | Red    | Clearance Marker | P2  | 0.18     |

For Retail Bag, add the suffix 'P' to the end of the Part No.

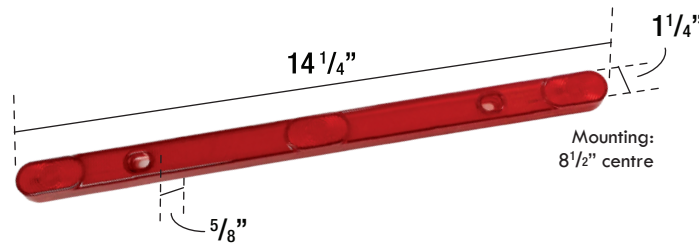

## 14" LED Clearance Marker Slim Line Bar

LED: 3 Diodes  
Submersible, Polycarbonate Lens • 12V

| Part No.                           | Colour | Function         | SAE | Amp Draw |
|------------------------------------|--------|------------------|-----|----------|
| <b>Connection: (2x) Lead Wires</b> |        |                  |     |          |
| <b>LLB1014P-3R</b>                 | Red    | Clearance Marker | P2  | 0.02     |

| Part No.                                       | Colour | Function         | SAE | Amp Draw |
|--|--------|------------------|-----|----------|
| <b>Connection: (2x) 0.18" Bullet Connector</b> |        |                  |     |          |
| <b>LLB1014P-3R1</b>                            | Red    | Clearance Marker | P2  | 0.02     |

For Retail Bag, add the suffix 'P' to the end of the Part No.



# LICENSE PLATE HOLDERS

DOT / SAE / ECE R112 compliant performance LED driving lamps with state of the art optic system. High lumen output with low power consumption. Finned aluminum body for heat dissipation. Emits natural white light which reduces eye fatigue.

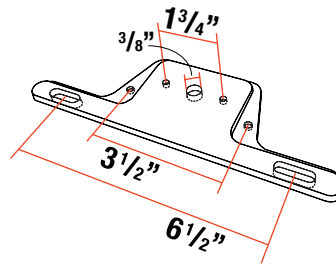
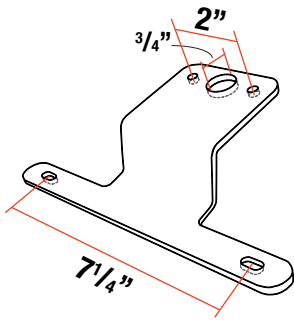

## Standard Profile License Plate Holder

| Part No. | Overall Dimension | Material       |
|----------|-------------------|----------------|
| LH2070   | 9" x 5"           | Heavy Duty ABS |

## Low Profile License Plate Holder

| Part No. | Overall Dimension | Material           |
|----------|-------------------|--------------------|
| LH2100   | 8.5" x 3"         | Polypropylene      |
| LH2100S  | 8.5" x 3"         | Black Coated Steel |

# LICENSE LAMPS

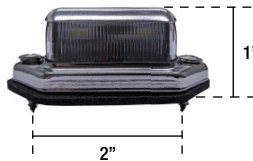

## Mini Hooded License Lamp

Chrome Plated Steel Housing & Polycarbonate Lens w/ Hooded Visor • 12V  
Mounting: 2" centre  
License Plate Holder: LH2070

| Part No. | Type         | Diodes/Bulb | Function | SAE | Amp Draw |
|----------|--------------|-------------|----------|-----|----------|
| LLP2020  | LED          | 2 Diodes    | License  | L   | 0.1      |
| DL2020   | Incandescent | #193        | License  | L   | 0.27     |

For Retail Bag, add the suffix 'P' to the end of the Part No.

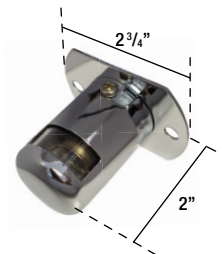

## Shield Point License Lamp

Chrome Plated Steel Housing & Polycarbonate Lens • 12V  
Mounting: 2" centre  
License Plate Holder: LH2070

| Part No. | Type         | Diodes/Bulb | Function | SAE | Amp Draw |
|----------|--------------|-------------|----------|-----|----------|
| LLP3000  | LED          | 2 Diodes    | License  | L   | 0.08     |
| LP3000   | Incandescent | #67         | License  | L   | 0.59     |

For Retail Bag, add the suffix 'P' to the end of the Part No.

# LICENSE LAMPS



## Hole Mounted License Lamp

Chrome Plated Brass Bezel, Steel Socket & Polycarbonate Lens • 12V  
Suggested Hole Size: 1.19" dia.

| Part No.       | Type | Diodes/Bulb | Function | SAE | Amp Draw |
|----------------|------|-------------|----------|-----|----------|
| <b>LLP1003</b> | LED  | 1 Diode     | License  | L   | 0.1      |

For Retail Bag, add the suffix 'P' to the end of the Part No.

Sealed Polycarbonate Lens w/ (2x) 0.18" bullet connectors  
Suggested Hole Size: 0.81" dia.

| Part No.        | Type | Diodes/Bulb | Function | SAE | Amp Draw |
|-----------------|------|-------------|----------|-----|----------|
| <b>LED0721L</b> | LED  | 1 Diode     | License  | L   | 0.04     |

For Retail Bag, add the suffix 'P' to the end of the Part No.

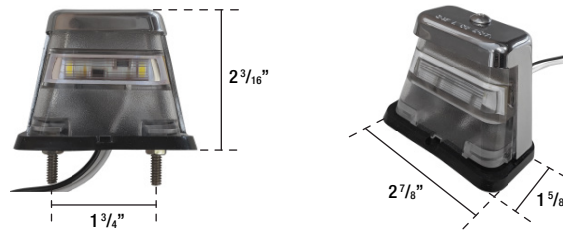

## Medium Profile License Lamp

Chrome ABS Housing & Polycarbonate Lens • 12V  
Mounting: 1.75" centre  
License Plate Holder: LH2100 / LH2100S

| Part No.       | Type | Diodes/Bulb | Function | SAE | Amp Draw |
|----------------|------|-------------|----------|-----|----------|
| <b>LLP1004</b> | LED  | 2 Diode     | License  | L   | 1.0      |

For Retail Bag, add the suffix 'P' to the end of the Part No.

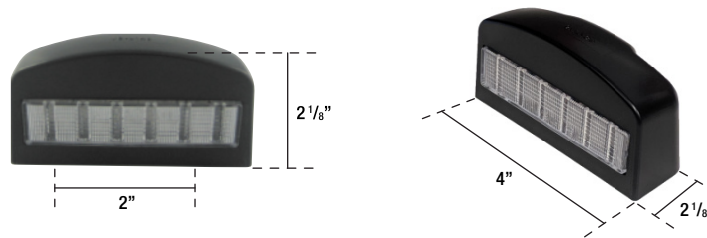

## Wide Profile License Lamp

ABS Housing & Acrylic Lens • 12V  
Mounting: 2" centre  
License Plate Holder: LH2070

| Part No.       | Type | Diodes/Bulb | Function | SAE | Amp Draw |
|----------------|------|-------------|----------|-----|----------|
| <b>LLP2002</b> | LED  | 12 Diode    | License  | L   | 1.1      |

For Retail Bag, add the suffix 'P' to the end of the Part No.



## 2" Rectangular License Lamps

Sealed Polycarbonate Lens & Base • 12V

| Part No.           | Colour | Function | SAE | Amp Draw |
|--------------------|--------|----------|-----|----------|
| <b>LED Version</b> |        |          |     |          |
| <b>LED1225-2L</b>  | White  | License  | L   | 0.03     |

|                             |       |         |   |      |
|-----------------------------|-------|---------|---|------|
| <b>Incandescent Version</b> |       |         |   |      |
| <b>SE1225L</b>              | White | License | L | 0.33 |

For Retail Bag, add the suffix 'P' to the end of each Part No.

|                             |  |
|-----------------------------|--|
| <b>Pigtails</b>             | PT6020 / PT6022                                    |
| <b>License Plate Holder</b> | LH2070   |
| <b>Replacement Housing</b>  | LP2000 (Grey) / LP2000B (Black) / LP2000C (Chrome) |

| LED KITS        |   |
|-----------------|---|
| <b>LLP2101</b>  | LED • Grey Housing                          |
| <b>LLP2101B</b> | LED • Black Housing                         |
| <b>LLP2101C</b> | LED • Chrome Housing                        |
| <b>LLP2102</b>  | LED • Grey Housing • Single Contact Pigtail |
| <b>LLP2102B</b> | LED • Grey Housing • Single Contact Pigtail |
| <b>LLP2102C</b> | LED • Grey Housing • Single Contact Pigtail |

| INCANDESCENT KITS |  |
|-------------------|--|
| <b>LP2001</b>     | Incandescent • Grey Housing                          |
| <b>LP2001B</b>    | Incandescent • Black Housing                         |
| <b>LP2001C</b>    | Incandescent • Chrome Housing                        |
| <b>LP2002</b>     | Incandescent • Grey Housing • Single Contact Pigtail |
| <b>LP2002B</b>    | Incandescent • Grey Housing • Single Contact Pigtail |
| <b>LP2002C</b>    | Incandescent • Grey Housing • Single Contact Pigtail |



# TWO-HOLE LED MODULES - 1 DIODE

Module is a durable steel housing, powder coated for resistance to road salt and moisture. Complete modules are available in universal mount without side marker and left & right mount with side marker. Includes all harnesses & reflectors as needed.



| Part No.       | SAE | Position  |
|----------------|-----|-----------|
| <b>TM9001U</b> | STI | Universal |

|                           |                             |
|---------------------------|-----------------------------|
| Component 1 - Tail Light  | (2x) LED4000-1R             |
| Component 2 - Signal      | -                           |
| Component 3 - Reflector   | (1x) RF2012R                |
| Component 4 - Side Marker | -                           |
| Wire Harness              | PT9000                      |
| Amp Draw                  | 0.1 / 0.4 @ 12V             |
| Housing                   | Aluminum                    |
| Lens                      | Polycarbonate               |
| Dimensions                | 12.75" L x 7.75" W x 2.5" H |



| Part No.       | SAE   | Position |
|----------------|-------|----------|
| <b>TM9601U</b> | STI/I | Right    |
| <b>TM9701U</b> | STI/I | Left     |

|                           |                             |
|---------------------------|-----------------------------|
| Component 1 - Tail Light  | (1x) LED4000-1R             |
| Component 2 - Signal      | (1x) LED4000-1A             |
| Component 3 - Reflector   | (1x) RF2012R                |
| Component 4 - Side Marker | -                           |
| Wire Harness              | PT9000                      |
| Amp Draw                  | 0.1 / 0.4 @ 12V             |
| Housing                   | Aluminum                    |
| Lens                      | Polycarbonate               |
| Dimensions                | 12.75" L x 7.75" W x 2.5" H |



| Part No.       | SAE | Position  |
|----------------|-----|-----------|
| <b>TM9001L</b> | STI | Driver    |
| <b>TM9001R</b> | STI | Passenger |

|                           |                             |
|---------------------------|-----------------------------|
| Component 1 - Tail Light  | (2x) LED4000-1R             |
| Component 2 - Signal      | -                           |
| Component 3 - Reflector   | (1x) RF2012R                |
| Component 4 - Side Marker | (1x) LED1040-4R             |
| Wire Harness              | PT9050                      |
| Amp Draw                  | 0.1 / 0.4 @ 12V             |
| Housing                   | Aluminum                    |
| Lens                      | Polycarbonate               |
| Dimensions                | 12.75" L x 7.75" W x 2.5" H |

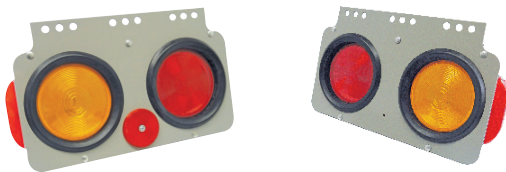

| Part No.       | SAE   | Position  |
|----------------|-------|-----------|
| <b>TM9801L</b> | STI/I | Driver    |
| <b>TM9801R</b> | STI/I | Passenger |

|                           |                             |
|---------------------------|-----------------------------|
| Component 1 - Tail Light  | (1x) LED4000-1R             |
| Component 2 - Signal      | (1x) LED4000-1A             |
| Component 3 - Reflector   | (1x) RF2012R                |
| Component 4 - Side Marker | (1x) LED1040-4R             |
| Wire Harness              | PT9050                      |
| Amp Draw                  | 0.1 / 0.4 @ 12V             |
| Housing                   | Aluminum                    |
| Lens                      | Polycarbonate               |
| Dimensions                | 12.75" L x 7.75" W x 2.5" H |

# TWO-HOLE LED MODULES - 10 DIODES

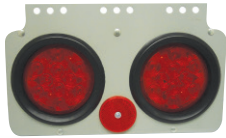

| Part No.       | SAE    | Position  |
|----------------|--------|-----------|
| <b>TM9010U</b> | S2T2I6 | Universal |

|                           |                             |
|---------------------------|-----------------------------|
| Component 1 - Tail Light  | (2x) LED4000-10R            |
| Component 2 - Signal      | -                           |
| Component 3 - Reflector   | (1x) RF2012R                |
| Component 4 - Side Marker | -                           |
| Wire Harness              | PT9000                      |
| Amp Draw                  | 0.02 / 0.18 @ 12V           |
| Housing                   | Aluminum                    |
| Lens                      | Polycarbonate               |
| Dimensions                | 12.75" L x 7.75" W x 2.5" H |



| Part No.       | SAE        | Position |
|----------------|------------|----------|
| <b>TM9610U</b> | S2T2I6/I6P | Right    |
| <b>TM9710U</b> | S2T2I6/I6P | Left     |

|                           |                             |
|---------------------------|-----------------------------|
| Component 1 - Tail Light  | (1x) LED4000-10R            |
| Component 2 - Signal      | (1x) LED4000-10A            |
| Component 3 - Reflector   | (1x) RF2012R                |
| Component 4 - Side Marker | -                           |
| Wire Harness              | PT9000                      |
| Amp Draw                  | 0.01 / 0.29 @ 12V           |
| Housing                   | Aluminum                    |
| Lens                      | Polycarbonate               |
| Dimensions                | 12.75" L x 7.75" W x 2.5" H |

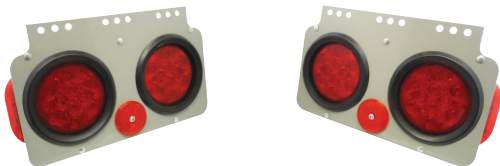

| Part No.       | SAE    | Position  |
|----------------|--------|-----------|
| <b>TM9010L</b> | S2T2I6 | Driver    |
| <b>TM9010R</b> | S2T2I6 | Passenger |

|                           |                             |
|---------------------------|-----------------------------|
| Component 1 - Tail Light  | (2x) LED4000-10R            |
| Component 2 - Signal      | -                           |
| Component 3 - Reflector   | (1x) RF2012R                |
| Component 4 - Side Marker | (1x) LED1040-4R             |
| Wire Harness              | PT9050                      |
| Amp Draw                  | 0.04 / 0.22 @ 12V           |
| Housing                   | Aluminum                    |
| Lens                      | Polycarbonate               |
| Dimensions                | 12.75" L x 7.75" W x 2.5" H |

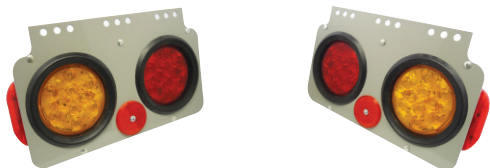

| Part No.       | SAE        | Position  |
|----------------|------------|-----------|
| <b>TM9810L</b> | S2T2I6/I6P | Driver    |
| <b>TM9810R</b> | S2T2I6/I6P | Passenger |

|                           |                             |
|---------------------------|-----------------------------|
| Component 1 - Tail Light  | (1x) LED4000-10R            |
| Component 2 - Signal      | (1x) LED4000-10A            |
| Component 3 - Reflector   | (1x) RF2012R                |
| Component 4 - Side Marker | (1x) LED1040-4R             |
| Wire Harness              | PT9050                      |
| Amp Draw                  | 0.03 / 0.31 @ 12V           |
| Housing                   | Aluminum                    |
| Lens                      | Polycarbonate               |
| Dimensions                | 12.75" L x 7.75" W x 2.5" H |



# TWO-HOLE LED MODULES - 24 DIODES



| Part No.       | SAE | Position  |
|----------------|-----|-----------|
| <b>TM9024U</b> | STI | Universal |

|                           |                             |
|---------------------------|-----------------------------|
| Component 1 - Tail Light  | (2x) LED4000-24R            |
| Component 2 - Signal      | -                           |
| Component 3 - Reflector   | (1x) RF2012R                |
| Component 4 - Side Marker | -                           |
| Wire Harness              | PT9000                      |
| Amp Draw                  | 0.02 / 0.8 @ 12V            |
| Housing                   | Aluminum                    |
| Lens                      | Polycarbonate               |
| Dimensions                | 12.75" L x 7.75" W x 2.5" H |



| Part No.       | SAE    | Position |
|----------------|--------|----------|
| <b>TM9624U</b> | STI/IP | Right    |
| <b>TM9724U</b> | STI/IP | Left     |

|                           |                             |
|---------------------------|-----------------------------|
| Component 1 - Tail Light  | (1x) LED4000-24R            |
| Component 2 - Signal      | (1x) LED4000-24A            |
| Component 3 - Reflector   | (1x) RF2012R                |
| Component 4 - Side Marker | -                           |
| Wire Harness              | PT9000                      |
| Amp Draw                  | 0.02 / 0.8 @ 12V            |
| Housing                   | Aluminum                    |
| Lens                      | Polycarbonate               |
| Dimensions                | 12.75" L x 7.75" W x 2.5" H |



| Part No.       | SAE | Position  |
|----------------|-----|-----------|
| <b>TM9024L</b> | STI | Driver    |
| <b>TM9024R</b> | STI | Passenger |

|                           |                             |
|---------------------------|-----------------------------|
| Component 1 - Tail Light  | (2x) LED4000-24R            |
| Component 2 - Signal      | -                           |
| Component 3 - Reflector   | (1x) RF2012R                |
| Component 4 - Side Marker | (1x) LED1040-4R             |
| Wire Harness              | PT9050                      |
| Amp Draw                  | 0.06 / 0.1 @ 12V            |
| Housing                   | Aluminum                    |
| Lens                      | Polycarbonate               |
| Dimensions                | 12.75" L x 7.75" W x 2.5" H |



| Part No.       | SAE    | Position  |
|----------------|--------|-----------|
| <b>TM9824L</b> | STI/IP | Driver    |
| <b>TM9824R</b> | STI/IP | Passenger |

|                           |                             |
|---------------------------|-----------------------------|
| Component 1 - Tail Light  | (1x) LED4000-24R            |
| Component 2 - Signal      | (1x) LED4000-24A            |
| Component 3 - Reflector   | (1x) RF2012R                |
| Component 4 - Side Marker | (1x) LED1040-4R             |
| Wire Harness              | PT9050                      |
| Amp Draw                  | 0.06 / 0.1 @ 12V            |
| Housing                   | Aluminum                    |
| Lens                      | Polycarbonate               |
| Dimensions                | 12.75" L x 7.75" W x 2.5" H |

# TWO-HOLE INCANDESCENT MODULES



| Part No.       | SAE  | Position  |
|----------------|------|-----------|
| <b>TM8050U</b> | STIP | Universal |

|                           |                             |
|---------------------------|-----------------------------|
| Component 1 - Tail Light  | (2x) SE4000R                |
| Component 2 - Signal      | -                           |
| Component 3 - Reflector   | (1x) RF2012R                |
| Component 4 - Side Marker | -                           |
| Wire Harness              | PT9000                      |
| Amp Draw                  | 0.1 / 0.4 @ 12V             |
| Housing                   | Aluminum                    |
| Lens                      | Polycarbonate               |
| Dimensions                | 12.75" L x 7.75" W x 2.5" H |



| Part No.       | SAE     | Position |
|----------------|---------|----------|
| <b>TM8060U</b> | STIP/IP | Right    |
| <b>TM8070U</b> | STIP/IP | Left     |

|                           |                             |
|---------------------------|-----------------------------|
| Component 1 - Tail Light  | (1x) SE4000R                |
| Component 2 - Signal      | (1x) SE4000A                |
| Component 3 - Reflector   | (1x) RF2012R                |
| Component 4 - Side Marker | -                           |
| Wire Harness              | PT9000                      |
| Amp Draw                  | 0.1 / 0.4 @ 12V             |
| Housing                   | Aluminum                    |
| Lens                      | Polycarbonate               |
| Dimensions                | 12.75" L x 7.75" W x 2.5" H |



| Part No.       | SAE  | Position  |
|----------------|------|-----------|
| <b>TM8050L</b> | STIP | Driver    |
| <b>TM8050R</b> | STIP | Passenger |

|                           |                             |
|---------------------------|-----------------------------|
| Component 1 - Tail Light  | (2x) SE4000R                |
| Component 2 - Signal      | -                           |
| Component 3 - Reflector   | (1x) RF2012R                |
| Component 4 - Side Marker | (1x) SE1040R                |
| Wire Harness              | PT9050                      |
| Amp Draw                  | 0.1 / 0.4 @ 12V             |
| Housing                   | Aluminum                    |
| Lens                      | Polycarbonate               |
| Dimensions                | 12.75" L x 7.75" W x 2.5" H |



| Part No.       | SAE     | Position  |
|----------------|---------|-----------|
| <b>TM8070L</b> | STIP/IP | Driver    |
| <b>TM8060R</b> | STIP/IP | Passenger |

|                           |                             |
|---------------------------|-----------------------------|
| Component 1 - Tail Light  | (1x) SE4000R                |
| Component 2 - Signal      | (1x) SE4000A                |
| Component 3 - Reflector   | (1x) RF2012R                |
| Component 4 - Side Marker | (1x) SE1040R                |
| Wire Harness              | PT9050                      |
| Amp Draw                  | 0.1 / 0.4 @ 12V             |
| Housing                   | Aluminum                    |
| Lens                      | Polycarbonate               |
| Dimensions                | 12.75" L x 7.75" W x 2.5" H |

# THREE-HOLE MODULES

Module is a durable steel housing, powder coated for resistance to road salt and moisture. Complete modules are available in universal mount without side marker and left & right mount with side marker. Includes all harnesses & reflectors as needed.



| Part No.       | Component 1     | Component 2     |
|----------------|-----------------|-----------------|
| <b>TM9301U</b> | (3x) LED4000-1R | -               |
| <b>TM9401U</b> | (2x) LED4000-1R | (1x) LED4000-1A |

|                           |                          |
|---------------------------|--------------------------|
| Component 3 - Reflector   | (2x) RF2012R             |
| Component 4 - Side Marker | -                        |
| Type                      | LED 1-Diode              |
| SAE                       | STI/I                    |
| Wire Harness              | PT9300 / PT9330          |
| Amp Draw                  | 0.03 / 0.6 @ 12V         |
| Housing                   | Aluminum                 |
| Lens                      | Polycarbonate            |
| Dimensions                | 20" L x 7.75" W x 2.5" H |



| Part No.       | Component 1      | Component 2      |
|----------------|------------------|------------------|
| <b>TM9310U</b> | (3x) LED4000-10R | -                |
| <b>TM9410U</b> | (2x) LED4000-10R | (1x) LED4000-10A |

|                           |                          |
|---------------------------|--------------------------|
| Component 3 - Reflector   | (2x) RF2012R             |
| Component 4 - Side Marker | -                        |
| Type                      | LED 10-Diode             |
| SAE                       | S2T216/16P               |
| Wire Harness              | PT9300 / PT9330          |
| Amp Draw                  | 0.03 / 0.4 @ 12V         |
| Housing                   | Aluminum                 |
| Lens                      | Polycarbonate            |
| Dimensions                | 20" L x 7.75" W x 2.5" H |



| Part No.       | Component 1      | Component 2      |
|----------------|------------------|------------------|
| <b>TM9324U</b> | (3x) LED4000-24R | -                |
| <b>TM9424U</b> | (2x) LED4000-24R | (1x) LED4000-24A |

|                           |                          |
|---------------------------|--------------------------|
| Component 3 - Reflector   | (2x) RF2012R             |
| Component 4 - Side Marker | -                        |
| Type                      | LED 24-Diode             |
| SAE                       | STI/IP                   |
| Wire Harness              | PT9300 / PT9330          |
| Amp Draw                  | 0.06 / 1.2 @ 12V         |
| Housing                   | Aluminum                 |
| Lens                      | Polycarbonate            |
| Dimensions                | 20" L x 7.75" W x 2.5" H |



| Part No.       | Component 1  | Component 2  |
|----------------|--------------|--------------|
| <b>TM3050U</b> | (3x) SE4000R | -            |
| <b>TM3053U</b> | (2x) SE4000R | (1x) SE4000A |

|                           |                          |
|---------------------------|--------------------------|
| Component 3 - Reflector   | (2x) RF2012R             |
| Component 4 - Side Marker | -                        |
| Type                      | Incandescent             |
| SAE                       | STIP/IP                  |
| Wire Harness              | PT9300 / PT9330          |
| Amp Draw                  | 1.44 / 6.30 @ 12V        |
| Housing                   | Aluminum                 |
| Lens                      | Polycarbonate            |
| Dimensions                | 20" L x 7.75" W x 2.5" H |

# HEAVY DUTY LED - MAGNETIC MOUNT

Kits are available in different options for use on tow trucks, cars, boats, trailers and RVs. LEDs are more resistant to vibration than incandescent lamps. Rubber-like bodies are shock resistant. Plated hardware resists corrosion. All are easy to install and connect to standard vehicle lighting systems.

Heavy Duty Cable available in optional lengths on request. Contact your distributor for more information.



4-pin die cast trailer end connector w/ cable guard



7-blade ABS RV trailer end connector



4-way flat trailer end connector



4-pin die cast trailer end connector



| Part No.         | Connection  |
|------------------|---|
| <b>TW4110-1R</b> | 4-pin die cast trailer end connector w/ cable guard |
| <b>TW4111-1R</b> | 7-blade ABS RV trailer end connector                |
| <b>TW4112-1R</b> | 4-way flat trailer end connector                    |
| <b>TW4100-1R</b> | 4-pin die cast trailer end connector                |

|                            |                         |
|----------------------------|-------------------------|
| Component 1                | (2x) LED4000-1R         |
| Component 2                | (2x) Heavy Duty Magnets |
| Component 3 (customizable) | 30 ft Heavy Duty Cable  |
| Type                       | LED 1-Diode             |
| SAE                        | STI                     |
| Amp Draw                   | 0.1 / 0.4 @ 12V         |
| Housing                    | Rubber                  |
| Lens                       | Polycarbonate           |



| Part No.          | Connection  |
|-------------------|---|
| <b>TW4110-10R</b> | 4-pin die cast trailer end connector w/ cable guard |
| <b>TW4111-10R</b> | 7-blade ABS RV trailer end connector                |
| <b>TW4112-10R</b> | 4-way flat trailer end connector                    |
| <b>TW4100-10R</b> | 4-pin die cast trailer end connector                |

|                            |                         |
|----------------------------|-------------------------|
| Component 1                | (2x) LED4000-10R        |
| Component 2                | (2x) Heavy Duty Magnets |
| Component 3 (customizable) | 30 ft Heavy Duty Cable  |
| Type                       | LED 1-Diode             |
| SAE                        | S2T2I6                  |
| Amp Draw                   | 0.02 / 0.2 @ 12V        |
| Housing                    | Rubber                  |
| Lens                       | Polycarbonate           |



| Part No.          | Connection  |
|-------------------|---|
| <b>TW4110-24R</b> | 4-pin die cast trailer end connector w/ cable guard |
| <b>TW4111-24R</b> | 7-blade ABS RV trailer end connector                |
| <b>TW4112-24R</b> | 4-way flat trailer end connector                    |
| <b>TW4100-24R</b> | 4-pin die cast trailer end connector                |

|                            |                         |
|----------------------------|-------------------------|
| Component 1                | (2x) LED4000-24R        |
| Component 2                | (2x) Heavy Duty Magnets |
| Component 3 (customizable) | 30 ft Heavy Duty Cable  |
| Type                       | LED 1-Diode             |
| SAE                        | STI                     |
| Amp Draw                   | 0.02 / 0.3 @ 12V        |
| Housing                    | Rubber                  |
| Lens                       | Polycarbonate           |

# HEAVY DUTY INCANDESCENT - MAGNETIC MOUNT

Kits are available in different options for use on tow trucks, cars, boats, trailers and RVs. LEDs are more resistant to vibration than incandescent lamps. Rubber-like bodies are shock resistant. Plated hardware resists corrosion. All are easy to install and connect to standard vehicle lighting systems.

Heavy Duty Cable available in optional lengths on request. Contact your distributor for more information.



4-pin die cast trailer end connector w/ cable guard



7-blade ABS RV trailer end connector



4-way flat trailer end connector



4-pin die cast trailer end connector



| Part No.       | Connection  |
|----------------|---|
| <b>TW4010R</b> | 4-pin die cast trailer end connector w/ cable guard |
| <b>TW4011R</b> | 7-blade ABS RV trailer end connector                |
| <b>TW4012R</b> | 4-way flat trailer end connector                    |
| <b>TW4000R</b> | 4-pin die cast trailer end connector                |

|                            |                         |
|----------------------------|-------------------------|
| Component 1                | (2x) SE4000R            |
| Component 2                | (2x) Heavy Duty Magnets |
| Component 3 (customizable) | 30 ft Heavy Duty Cable  |
| Type                       | Incandescent            |
| SAE                        | STIP                    |
| Amp Draw                   | 4.20 @ 12V              |
| Housing                    | Rubber                  |
| Lens                       | Polycarbonate           |



| Part No.       | Connection   |
|----------------|--|
| <b>TW4502R</b> | 4-wire flat ribbon cable w/ trunk & trailer connectors |

|             |                         |
|-------------|-------------------------|
| Component 1 | (2x) FM4402R            |
| Component 2 | (2x) Heavy Duty Magnets |
| Component 3 | 20 ft cable             |
| Type        | Incandescent            |
| SAE         | STIP                    |
| Amp Draw    | 4.20 @ 12V              |
| Housing     | ABS                     |
| Lens        | Acrylic                 |



# REPLACEMENT MINI BULBS

Replacement Bulbs made to Industry Standards. Available in most popular applications.



| Part No.           | Colour | Diodes | Type                                | Amp Draw | Case Qty |
|--------------------|--------|--------|-------------------------------------|----------|----------|
| <b>LED194-5W-2</b> | White  | 5      | LED Single Contact - Fits 194 Base  | 0.1      |          |
| <b>LED1156-24A</b> | Amber  | 24     | LED Single Contact - Fits 1156 Base | 0.1      |          |
| <b>LED1157-24A</b> | Amber  | 24     | LED Double Contact - Fits 1157 Base | 0.1/0.4  |          |
| <b>LED1157-24W</b> | White  | 24     | LED Double Contact - Fits 1157 Base | 0.1/0.4  |          |
| <b>LED3156A</b>    | Amber  | 13     | LED Single Contact - Fits 3156 Base | 0.19     |          |
| <b>LED3156-24W</b> | White  | 24     | LED Single Contact - Fits 3156 Base | 0.4      |          |
| <b>LED3157-24W</b> | White  | 24     | LED Double Contact - Fits 3157 Base | 0.1/0.4  |          |

NOTE: All Bulbs are sold in packs of 10

For greater volumes, please contact your sales representative or customer service.



| Part No.       | Colour | CP       | Type  | Amp Draw    | Case Qty |
|----------------|--------|----------|---|-------------|----------|
| <b>HB67</b>    | Clear  | 4        | Incandescent Single Contact - Fits #67 Base   | 0.59        |          |
| <b>HB168</b>   | Clear  | 3        | Incandescent Single Contact - Fits #168 Base  | 0.35        |          |
| <b>HB194</b>   | Clear  | 2        | Incandescent Single Contact - Fits #194 Base  | 0.27        |          |
| <b>HB194A</b>  | Amber  | 1.5      | Incandescent Single Contact - Fits #194 Base  | 0.27        |          |
| <b>HB194B</b>  | Blue   | 2        | Incandescent Single Contact - Fits #194 Base  | 0.2         |          |
| <b>HB886</b>   | Clear  | 100      | Incandescent Single Contact - Fits #886 Base  | 3.90        |          |
| <b>HB896</b>   | Clear  | 75       | Incandescent Single Contact - Fits #896 Base  | 2.93        |          |
| <b>HB912</b>   | Clear  | 12       | Incandescent Single Contact - Fits #912 Base  | 1.00        |          |
| <b>HB1003</b>  | Clear  | 15       | Incandescent Single Contact - Fits #1003 Base | 0.94        |          |
| <b>HB1156</b>  | Clear  | 32       | Incandescent Single Contact - Fits #1156 Base | 2.10        |          |
| <b>HB1157</b>  | Clear  | 3 / 32   | Incandescent Double Contact - Fits #1157 Base | 0.59 / 2.10 |          |
| <b>HB1157A</b> | Amber  | 2.2 / 24 | Incandescent Double Contact - Fits #1157 Base | 0.59 / 2.10 |          |
| <b>HB1309</b>  | Clear  | 15       | Incandescent Single Contact - Fits #1309 Base | 0.52        |          |
| <b>HB1893</b>  | Clear  | 2        | Incandescent Single Contact - Fits #1893 Base | 0.33        |          |
| <b>HB1895</b>  | Clear  | 2        | Incandescent Single Contact - Fits #1895 Base | 0.27        |          |
| <b>HB2057</b>  | Clear  | 2 / 32   | Incandescent Double Contact - Fits #2057 Base | 0.48 / 2.10 |          |
| <b>HB3156</b>  | Clear  | 32       | Incandescent Single Contact - Fits #3156 Base | 2.10        |          |
| <b>HB3157</b>  | Clear  | 3 / 32   | Incandescent Double Contact - Fits #3157 Base | 0.59 / 2.10 |          |
| <b>HB3157A</b> | Amber  | 2.2 / 24 | Incandescent Double Contact - Fits #3157 Base | 0.59 / 2.10 |          |
| <b>HBT4W</b>   | Clear  | 2.8      | Incandescent Single Contact - Fits #T4 Base   | 0.3         |          |

NOTE: All Bulbs are sold in packs of 10

For greater volumes, please contact your sales representative or customer service.

# REPLACEMENT HALOGEN BULBS

Replacement Bulbs made to Industry Standards. Available in most popular applications.



**HB5501-12**



**HB5503-12**



**HB5503-12BW**



**HB5504-12**



**HB5507-12**



**HB5511-12**



**HB9004**



**HB9005**



**HB9006**



**HB9007**

| Part No.           | Colour       | Watts     | Type                       | Amp Draw | Case Qty |
|--------------------|--------------|-----------|----------------------------|----------|----------|
| <b>HB5501-12</b>   | White        | 55W       | Single Contact - Fits H1   | 4.70     |          |
| <b>HB1003-12</b>   | White        | 100W      | Single Contact - Fits H3   | 6.97     |          |
| <b>HB5503-12</b>   | White        | 55W       | Single Contact - Fits H3   | 4.58     |          |
| <b>HB5503-12BW</b> | Bright White | 55W       | Single Contact - Fits H3   | 4.58     |          |
| <b>HB7003-24</b>   | White        | 70W       | Single Contact - Fits H3   | 2.68     |          |
| <b>HB5504-12</b>   | White        | 60W / 55W | Double Contact - Fits H4   | 5.38     |          |
| <b>HB5507-12</b>   | White        | 55W       | Single Contact - Fits H7   | 4.29     |          |
| <b>HB5511-12</b>   | White        | 55W       | Single Contact - Fits H11  | 4.17     |          |
| <b>HB9004</b>      | White        | 65W / 45W | High/Low Beam - Fits #9004 | 5.08     |          |
| <b>HB9005</b>      | White        | 65W       | High Beam - Fits #9005     | 5.08     |          |
| <b>HB9006</b>      | White        | 55W       | Low Beam - Fits #9006      | 4.30     |          |
| <b>HB9007</b>      | White        | 65W / 55W | High/Low Beam - Fits #9007 | 5.08     |          |

NOTE: All Bulbs are sold in packs of 10

For greater volumes, please contact your sales representative or customer service.

# BACK-UP ALARMS

BACK-UP ALARMS  
AVERTISSEURS DE RECUL

Polarity protected. Solid state electronics are encapsulated in epoxy. Alarms are sealed against moisture, vibration and corrosion.  
Operating temperature: -35°C to 70°C. Models conform to SAE J994. Steam cleanable.

NOTE: Self adjusting units will automatically adjust to 5dB above ambient noise levels.

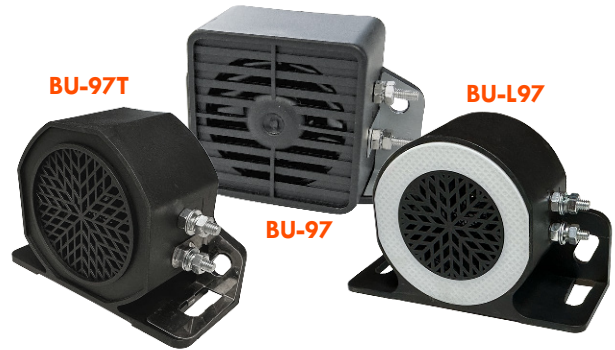
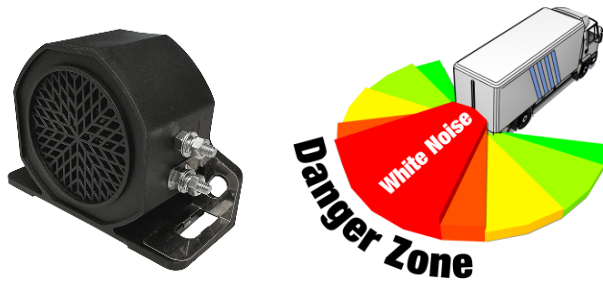

| Part No.      | Decibel Level | LED Light |
|---------------|---------------|-----------|
| <b>BU-97W</b> | 97dB          | None      |

| Part No.      | Decibel Level | LED Light            |
|---------------|---------------|----------------------|
| <b>BU-97</b>  | 97dB          | None                 |
| <b>BU-97T</b> | 97dB          | None                 |
| <b>BU-L97</b> | 97dB          | Caution Assist Light |

|            |              |
|------------|--------------|
| Type       | White Noise  |
| SAE        | Type C       |
| Voltage    | 10V - 80V DC |
| Amp Draw   | 0.6 @ 12V    |
| Housing    | Nylon        |
| Connection | 2x Bolts     |

|            |                 |
|------------|-----------------|
| Type       | Tonal Beep-Beep |
| SAE        | Type C          |
| Voltage    | 12V - 24V       |
| Amp Draw   | 0.8 @ 12V       |
| Housing    | Nylon           |
| Connection | 2x Bolts        |



| Part No.       | Decibel Level | LED Light |
|----------------|---------------|-----------|
| <b>BU-107T</b> | 107dB         | None      |

| Part No.       | Decibel Level                     | LED Light |
|----------------|-----------------------------------|-----------|
| <b>BU-112</b>  | 112dB                             | None      |
| <b>BU-112J</b> | 87dB to 112dB<br>(self-adjusting) | None      |

|            |                 |
|------------|-----------------|
| Type       | Tonal Beep-Beep |
| SAE        | Type B          |
| Voltage    | 12V - 24V       |
| Amp Draw   | 0.8 @ 12V       |
| Housing    | Nylon           |
| Connection | 2x Bolts        |

|            |                 |
|------------|-----------------|
| Type       | Tonal Beep-Beep |
| SAE        | Type A          |
| Voltage    | 12V - 24V       |
| Amp Draw   | 0.8 @ 12V       |
| Housing    | Nylon           |
| Connection | 2x Bolts        |

# CONVEX MIRRORS

Mirrors have powder coated steel bodies for long life. All mirrors are PVC extrusion and swagged glass to body construction to ensure positive glass to body fit. Nickel plated ball stud, plated hardware, stainless steel "L" bracket included.



| Part No.       | Type     |
|----------------|----------|
| <b>SM301AL</b> | Aluminum |

|          |          |
|----------|----------|
| Size     | 3" Dia.  |
| Mounting | Adhesive |



| Part No.       | Type    |
|----------------|---------|
| <b>SM375BP</b> | Plastic |

|          |            |
|----------|------------|
| Size     | 3.75" Dia. |
| Mounting | Adhesive   |



| Part No.       | Type     |
|----------------|----------|
| <b>SM554AL</b> | Aluminum |

|          |               |
|----------|---------------|
| Size     | 5.5" L x 4" H |
| Mounting | Adhesive      |



| Part No.       | Type            | Mounting                   |
|----------------|-----------------|----------------------------|
| <b>CX500SS</b> | Stainless Steel | Centre Mount - Round       |
| <b>CX544SS</b> | Stainless Steel | Centre Mount - Rectangular |

|         |          |
|---------|----------|
| Size    | 5"       |
| Bracket | "L" Type |

| Part No.       | Type            | Mounting     |
|----------------|-----------------|--------------|
| <b>CX600BE</b> | Black Enamel    | Centre Mount |
| <b>CX600SS</b> | Stainless Steel | Centre Mount |

|         |          |
|---------|----------|
| Size    | 6" Dia.  |
| Bracket | "L" Type |



| Part No.       | Type            | Mounting     |
|----------------|-----------------|--------------|
| <b>CX750SS</b> | Stainless Steel | Centre Mount |

|         |           |
|---------|-----------|
| Size    | 7.5" Dia. |
| Bracket | "L" Type  |

| Part No.       | Type            | Mounting     |
|----------------|-----------------|--------------|
| <b>CX850BE</b> | Black Enamel    | Centre Mount |
| <b>CX850SS</b> | Stainless Steel | Centre Mount |
| <b>CX855SS</b> | Stainless Steel | Offset Mount |

|         |           |
|---------|-----------|
| Size    | 8.5" Dia. |
| Bracket | "L" Type  |

# CONVEX MIRRORS

Mirrors have powder coated steel bodies for long life. All mirrors are PVC extrusion and swagged glass to body construction to ensure positive glass to body fit. Nickel plated ball stud, plated hardware, stainless steel "L" bracket included.



| Part No.       | Type            | Mounting               |
|----------------|-----------------|------------------------|
| <b>CX858SS</b> | Stainless Steel | Offset Mount w/ Heater |
| <b>CX859SS</b> | Stainless Steel | Centre Mount w/ Heater |

| Part No.      | Type                | Mounting     |
|---------------|---------------------|--------------|
| <b>CX120G</b> | Powder Coated Steel | Centre Mount |

|          |            |
|----------|------------|
| Size     | 8.5" Dia.  |
| Bracket  | "L" Type   |
| Voltage  | 12V        |
| Amp Draw | 0.92 @ 12V |

|          |             |
|----------|-------------|
| Size     | 12" Dia.    |
| Bracket  | Swivel Type |
| Voltage  | 12V         |
| Amp Draw | 0.92 @ 12V  |

## MIRROR ACCESSORIES



| Part No.                   | Description                | Material              | Case Qty |
|----------------------------|----------------------------|-----------------------|----------|
| <b>MIRROR ARMS</b>         |                            |                       |          |
| <b>HW1001</b>              | "L" Bracket                | Stainless Steel       |          |
| <b>HW1002</b>              | 4" Arm & Bracket           | Stainless Steel       |          |
| <b>WC3630</b>              | "Z" Arm Cowling Mount      | Stainless Steel       |          |
| <b>WC3650</b>              | Tripod Fender Arm          | Stainless Steel       |          |
| <b>MIRROR ARM ASSEMBLY</b> |                            |                       |          |
| <b>WC3670</b>              | 5 Arm Mirror Holding Mount | Stainless Steel       |          |
| <b>WC3672</b>              | 5 Arm Mirror Holding Mount | White Zinc Dichromate |          |



# WEST COAST MIRRORS

Heavy Duty stainless steel body. PVC extrusion mounted glass. Plated hardware with stainless steel screws.  
Heavy Duty heater pad for frost free operation. Heavy Duty weatherproof wiring.



| Part No.        | Model     | Amp Draw   |
|-----------------|-----------|------------|
| <b>OE7160SS</b> | Plain     | -          |
| <b>OE7165SS</b> | w/ Heater | 0.92 @ 12V |

|       |                         |
|-------|-------------------------|
| Style | OE (original equipment) |
| Size  | 7" x 16"                |

**Replacement Heater Pad** OE7165HP  
**Replacement Glass** OEG7160



| Part No.           | Model                        | Amp Draw   |
|--------------------|------------------------------|------------|
| <b>OE7169SS</b>    | w/ Heater & Light (#67 bulb) | 2.23 @ 12V |
| <b>OE7169SSL</b>   | w/ Heater & LED Light Pad    | 3.43 @ 12V |
| <b>OE7169SSL-9</b> | w/ Heater & LED Light Strip  | 3.43 @ 12V |

|       |                         |
|-------|-------------------------|
| Style | OE (original equipment) |
| Size  | 7" x 16"                |

**Replacement Heater Pad** OE7165HP  
**Replacement Glass** OEG7160



| Part No.        | Model     | Amp Draw   |
|-----------------|-----------|------------|
| <b>WC6165SS</b> | w/ Heater | 0.92 @ 12V |

|       |             |
|-------|-------------|
| Style | Aftermarket |
| Size  | 6" x 16"    |

**Replacement Glass** WC6160

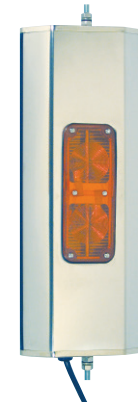

| Part No.        | Model                        | Amp Draw   |
|-----------------|------------------------------|------------|
| <b>WC7160SS</b> | Plain                        | -          |
| <b>WC7165SS</b> | w/ Heater                    | 0.92 @ 12V |
| <b>WC7169SS</b> | w/ Heater & Light (#67 bulb) | 2.23 @ 12V |

|       |             |
|-------|-------------|
| Style | Aftermarket |
| Size  | 7" x 16"    |

**Replacement Heater Pad** WC7165HP  
**Replacement Glass** WCG7160

# CONSPICUITY TAPES

Conspicuity tapes come in either 2" or 1" wide. Adhesive Back. Compliant to DOT standards.

Custom Logo can also be implemented on the conspicuity tapes. Contact your regional sales rep for more information.



| Part No.  | Colour             | Width | Length      | Compliance | Pkg        |
|-----------|--------------------|-------|-------------|------------|------------|
| RT20150RW | 6" Red   6" Silver | 2"    | 150 ft Roll | DOT        | Box        |
| RT2050RW  | 6" Red   6" Silver | 2"    | 50 ft Roll  | DOT        | Retail Bag |
| RT10150RW | 6" Red   6" Silver | 1"    | 150 ft Roll | DOT        | Box        |
| RT20150W  | Silver             | 2"    | 150 ft Roll | DOT        | Box        |
| RT2050W   | Silver             | 2"    | 50 ft Roll  | DOT        | Retail Bag |
| RT20150A  | Amber              | 2"    | 150 ft Roll | DOT        | Box        |
| RT2050A   | Amber              | 2"    | 50 ft Roll  | DOT        | Retail Bag |



All strips are cut to 12".

| Part No.    | Colour             | Width | Qty    | Compliance | Pkg        |
|-------------|--------------------|-------|--------|------------|------------|
| RT2001RW-5  | 6" Red   6" Silver | 2"    | 5 pcs  | DOT        | Retail Bag |
| RT2001RW-10 | 6" Red   6" Silver | 2"    | 10 pcs | DOT        | Retail Bag |
| RT1001RW-5  | 6" Red   6" Silver | 1"    | 5 pcs  | DOT        | Retail Bag |
| RT1001RW-10 | 6" Red   6" Silver | 1"    | 10 pcs | DOT        | Retail Bag |
| RT2001W-5   | Silver             | 2"    | 5 pcs  | DOT        | Retail Bag |
| RT2001W-10  | Silver             | 2"    | 10 pcs | DOT        | Retail Bag |
| RT2001A-5   | Amber              | 2"    | 5 pcs  | DOT        | Retail Bag |

# REFLECTORS

RF1301

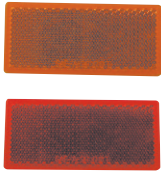

RF1501



RF2421



RF2001

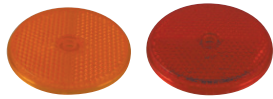

RF3001



RF2012

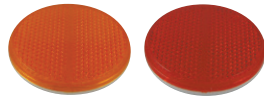

RF3012

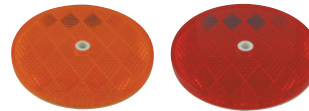

| Part No. | Colour | Dimension                   | Type   | SAE | Case Qty |
|----------|--------|-----------------------------|--|-----|----------|
| RF1301A  | Amber  | 3.13" L x 1.5" W x 0.25" D  | Adhesive Back                                  | A   | 200      |
| RF1301R  | Red    | 3.13" L x 1.5" W x 0.25" D  | Adhesive Back                                  | A   | 200      |
| RF1501A  | Amber  | 5.25" L x 1.38" W x 0.63" D | Angled & Adhesive Back                         | -   | 50       |
| RF2001A  | Amber  | 2.25" Dia. x 0.25" D        | Acrylic Lens, Adhesive Back                    | A   | 200      |
| RF2001R  | Red    | 2.25" Dia. x 0.25" D        | Acrylic Lens, Adhesive Back                    | A   | 200      |
| RF2012A  | Amber  | 2.25" Dia. x 0.25" D        | Plastic Back Centre Hole                       | A   | 200      |
| RF2012R  | Red    | 2.25" Dia. x 0.25" D        | Plastic Back Centre Hole                       | A   | 200      |
| RF3001A  | Amber  | 3.13" Dia. x 0.25" D        | Adhesive Back                                  | A   | 100      |
| RF3001R  | Red    | 3.13" Dia. x 0.25" D        | Adhesive Back                                  | A   | 100      |
| RF3012A  | Amber  | 3.13" Dia. x 0.25" D        | Acrylic Lens, ABS Base Centre Hole             | A   | 100      |
| RF3012R  | Red    | 3.13" Dia. x 0.25" D        | Acrylic Lens, ABS Base Centre Hole             | A   | 100      |
| RF2421A  | Amber  | 4.5" L x 2" W x 0.25" D     | Acrylic Lens, Adhesive Back & 2 Mounting Holes | A   | 100      |
| RF2421R  | Red    | 4.5" L x 2" W x 0.25" D     | Acrylic Lens, Adhesive Back & 2 Mounting Holes | A   | 100      |

For Retail Bag, add the suffix 'P' to the end of the Part No. All Part No. are sold as a unit of 1. The Case Qty is for reference only.

# BRANCH DEFLECTORS & BASE MOUNTS



| Part No.  | Colour | Dimension                 | Mounting    | Fitment                        | Case Qty |
|---|--------|---------------------------|-------------|--------------------------------|----------|
| <b>Branch Deflectors</b>                            |        |                           |             |                                |          |
| <b>BD2000</b>                                       | Gray   | 5.38" L x 2.75" W         | 4.5" centre | 2" Round Lamps                 | 100      |
| <b>BD2500</b>                                       | Gray   | 5.75" L x 3" W            | 4.5" centre | 2.5" Round Lamps               | 100      |
| <b>Base Mounts</b>                                  |        |                           |             |                                |          |
| <b>BM1020C</b>                                      | Chrome | 2.88" L x 1.5" W x 0.5" H | 2" centre   | 2" x 1" Rectangular Lamps      | 50       |
| <b>BM1020CB</b>                                     | Black  | 2.88" L x 1.5" W x 0.5" H | 2" centre   | 2" x 1" Rectangular Lamps      | 50       |
| <b>BM1020CG</b>                                     | Gray   | 2.88" L x 1.5" W x 0.5" H | 2" centre   | 2" x 1" Rectangular Lamps      | 50       |
| <b>Base Mounts w/ Built-In Ground &amp; Hotwire</b> |        |                           |             |                                |          |
| <b>BM1021C</b>                                      | Chrome | 2.88" L x 1.5" W x 0.5" H | 2" centre   | 2" x 1" Rectangular Lamps      | 50       |
| <b>BM1021CB</b>                                     | Black  | 2.88" L x 1.5" W x 0.5" H | 2" centre   | 2" x 1" Rectangular Lamps      | 50       |
| <b>BM1021CG</b>                                     | Gray   | 2.88" L x 1.5" W x 0.5" H | 2" centre   | 2" x 1" Rectangular Lamps      | 50       |
| <b>BM1040B</b>                                      | Gray   | 4" L x 1.5" W x 0.5" H    | 3" centre   | 4" x 1" Rectangular Lamps      | 50       |
| <b>BM1040BB</b>                                     | Black  | 4" L x 1.5" W x 0.5" H    | 3" centre   | 4" x 1" Rectangular Lamps      | 50       |
| <b>BM1040BC</b>                                     | Chrome | 4" L x 1.5" W x 0.5" H    | 3" centre   | 4" x 1" Rectangular Lamps      | 50       |
| <b>Hotwire for Base Mounts</b>                      | PT9011 |                           |             |                                |          |
| <b>Rail Mounts</b>                                  |        |                           |             |                                |          |
| <b>BM1020R</b>                                      | White  | 4.38" L x 1.38" W x 1"H   | 3.5" centre | 2" x 1" Rectangular Lamps      | 50       |
| <b>BM1020RB</b>                                     | Black  | 4.38" L x 1.38" W x 1"H   | 3.5" centre | 2" x 1" Rectangular Lamps      | 50       |
| <b>BM1020RG</b>                                     | Gray   | 4.38" L x 1.38" W x 1"H   | 3.5" centre | 2" x 1" Rectangular Lamps      | 50       |
| <b>Fender Mount Bracket</b>                         |        |                           |             |                                |          |
| <b>BM9925</b>                                       | Black  | -                         | -           | 2" x 1" Rectangular Lamps (2x) | 200      |

For Retail Bag, add the suffix 'P' to the end of the Part No. All Part No. are sold as a unit of 1. The Case Qty is for reference only.

# CHROME BEZELS

**BZ0700**



**BZ2000**



**BZ2000V**



**BZ2500**



**BZ2500V**



**BZ2238**



**BZ2238V**



**BZ2238-5S**



**BZ4000**



**BZ4000V**

| Part No.         | Visor | Dimension                     | Mounting     | Fitment            | Case Qty |
|------------------|-------|-------------------------------|--------------|--------------------|----------|
| <b>BZ0700</b>    | No    | Overall: 1.13" / Inside: 0.8" | 0.75" centre | 0.75" Penny Lamps  | 500      |
| <b>BZ2000</b>    | No    | Overall: 1.13" / Inside: 0.8" | 2.5" centre  | 2" Round Lamps     | 400      |
| <b>BZ2000V</b>   | Yes   | Overall: 1.13" / Inside: 0.8" | 2.5" centre  | 2" Round Lamps     | 400      |
| <b>BZ2500</b>    | No    | Overall: 1.13" / Inside: 0.8" | 3.25" centre | 2.5" Round Lamps   | 300      |
| <b>BZ2500V</b>   | Yes   | Overall: 1.13" / Inside: 0.8" | 3.25" centre | 2.5" Round Lamps   | 300      |
| <b>BZ2238</b>    | No    | Overall: 1.13" / Inside: 0.8" | 7" centre    | 6" Oval Lamps      | 200      |
| <b>BZ2238V</b>   | Yes   | Overall: 1.13" / Inside: 0.8" | 7" centre    | 6" Oval Lamps      | 50       |
| <b>BZ2238-5S</b> | No    | Overall: 1.13" / Inside: 0.8" | Snap-On      | LEDS2238-10 SERIES | 200      |
| <b>BZ4000</b>    | No    | Overall: 1.13" / Inside: 0.8" | 5" centre    | 4" Round Lamps     | 200      |
| <b>BZ4000V</b>   | Yes   | Overall: 1.13" / Inside: 0.8" | 5" centre    | 4" Round Lamps     | 50       |

For Retail Bag, add the suffix 'P' to the end of the Part No. **All Part No. are sold as a unit of 1. The Case Qty is for reference only.**





| Part No.  | Type            | Dimension        | Suggested Hole Size      | Fitment                   | Case Qty |
|-----------|-----------------|------------------|--------------------------|---------------------------|----------|
| FL2000    | ABS White       | 3" Dia.          | 2.31" Dia.               | 2" Round Lamps            | 300      |
| FL2001    | ABS Black       | 3" Dia.          | 2.31" Dia.               | 2" Round Lamps            | 300      |
| FL2002    | ABS Gray        | 3" Dia.          | 2.31" Dia.               | 2" Round Lamps            | 300      |
| FL2005    | ABS Chrome      | 3" Dia.          | 2.31" Dia.               | 2" Round Lamps            | 300      |
| FL2500    | ABS White       | 3.5" Dia.        | 2.78" Dia.               | 2.5" Round Lamps          | 200      |
| FL2501    | ABS Black       | 3.5" Dia.        | 2.78" Dia.               | 2.5" Round Lamps          | 200      |
| FL2502    | ABS Gray        | 3.5" Dia.        | 2.78" Dia.               | 2.5" Round Lamps          | 200      |
| FL2505    | ABS Chrome      | 3.5" Dia.        | 2.78" Dia.               | 2.5" Round Lamps          | 200      |
| FL2238-0  | ABS White       | 7.75" L x 3.5" W | 6.88" L x 2.56" W (oval) | 6" Oval Lamps             | 100      |
| FL2238-11 | ABS Black       | 7.75" L x 3.5" W | 6.88" L x 2.56" W (oval) | 6" Oval Lamps             | 100      |
| FL2238-2  | ABS Gray        | 7.75" L x 3.5" W | 6.88" L x 2.56" W (oval) | 6" Oval Lamps             | 100      |
| FL2238-5  | ABS Chrome      | 7.75" L x 3.5" W | 6.88" L x 2.56" W (oval) | 6" Oval Lamps             | 100      |
| FL4060SS  | Stainless Steel | 6.5" L x 4.63" W | 5.38" L x 3.5" W         | 6" x 4" Rectangular Lamps | 100      |
| FL4000    | ABS White       | 5.5" Dia.        | 4.5" Dia.                | 4" Round Lamps            | 100      |
| FL4011    | ABS Black       | 5.5" Dia.        | 4.5" Dia.                | 4" Round Lamps            | 120      |
| FL4012    | ABS Gray        | 5.5" Dia.        | 4.5" Dia.                | 4" Round Lamps            | 120      |
| FL4000SS  | Stainless Steel | 5.5" Dia.        | 4.5" Dia.                | 4" Round Lamps            | 100      |

For Retail Bag, add the suffix 'P' to the end of the Part No. All Part No. are sold as a unit of 1. The Case Qty is for reference only.

# RUBBER GROMMETS & MOUNTING BRACKETS



| Part No. | Type        | Dimension                     | Suggested Hole Size    | Fitment                   | Case Qty |
|----------|-------------|-------------------------------|------------------------|---------------------------|----------|
| GR0700   | Open Back   | Overall: 1.13" / Inside: 0.8" | 0.75" Dia.             | 0.75" Penny Lamps         | 100      |
| GR1225   | Open Back   | 3" L x 1.38" W                | 2.63" L x 1.25" W      | 2" x 1" Rectangular Lamps | 200      |
| GR2000   | Open Back   | 2.88" Dia.                    | 2.31" Dia.             | 2" Round Lamps            | 25       |
| GR2001   | Closed Back | 2.88" Dia.                    | 2.31" Dia.             | 2" Round Lamps            | 25       |
| GR2000-Y | Open Back   | 2.88" Dia.                    | 2.31" Dia.             | 2" Round Lamps            | 50       |
| GR2500   | Open Back   | 3.38" Dia.                    | 2.78" Dia.             | 2.5" Round Lamps          | 50       |
| GR2501   | Closed Back | 3.38" Dia.                    | 2.78" Dia.             | 2.5" Round Lamps          | 50       |
| GR2502   | Recessed    | 3.38" Dia.                    | 2.78" Dia.             | 2.5" Round Lamps          | 50       |
| GR2238   | Open Back   | 7.38" L x 3.13" W             | 6.5" L x 2.5" W (oval) | 6" Oval Lamps             | 100      |
| GR2239   | Closed Back | 7.38" L x 3.13" W             | 6.5" L x 2.5" W (oval) | 6" Oval Lamps             | 50       |
| GR4000   | Open Back   | 5.25" Dia.                    | 4.5" Dia.              | 4" Round Lamps            | 100      |
| GR4001   | Closed Back | 5.25" Dia.                    | 4.5" Dia.              | 4" Round Lamps            | 60       |
| GR4060   | Open Back   | 6.38" L x 4.38" W             | 5.5" L x 3.63" W       | 6" x 4" Rectangular Lamps | 50       |

For Retail Bag, add the suffix 'P' to the end of the Part No. All Part No. are sold as a unit of 1. The Case Qty is for reference only.



| Part No. | Type        | Dimension                   | Mounting      | Fitment                   | Case Qty |
|----------|-------------|-----------------------------|---------------|---------------------------|----------|
| MB2000   | Right Angle | 4.25" L x 4.13" W x 1.88" H | 2.25" centres | 2" Round Lamps            | 50       |
| MB2500   | Right Angle | 4.25" L x 4.13" W x 1.88" H | 2.25" centres | 2.5" Round Lamps          | 50       |
| MB2238   | Right Angle | 8.25" L x 4" W x 1.88" H    | 6.5" centres  | 6" Oval Lamps             | 60       |
| MB4000   | Right Angle | 6" L x 6" W x 1.88" H       | 4" centres    | 4" Round Lamps            | 60       |
| MB4060   | Right Angle | 6.88" L x 5.88" W x 1.25" H | 4" centres    | 6" x 4" Rectangular Lamps | 10       |

For Retail Bag, add the suffix 'P' to the end of the Part No. All Part No. are sold as a unit of 1. The Case Qty is for reference only.

# PIGTAILS - SINGLE CONTACT



| Part No. | Connector Type                      | Connector Spacing/Length | Connection                            | Case Qty |
|----------|-------------------------------------|--------------------------|---------------------------------------|----------|
| PT2022   | Double Female 0.18" Bullet Terminal | 6" Length                | (2x) Lead Wires                       | 50       |
| PT6020   | 2 Prong                             | 6" Length                | (1x) Lead Wires<br>(1x) Ring Terminal | 500      |
| PT6020-2 | 2 Prong                             | 6" Spacing / 60" Length  | (2x) Lead Wires                       | 100      |
| PT6020-3 | 2 Prong                             | 10" Spacing / 30" Length | (2x) Lead Wires                       | 100      |
| PT6021   | 2 Prong                             | 6" Length                | (1x) Lead Wires<br>(1x) Ring Terminal | 500      |
| PT6022   | 2 Prong                             | 6" Length                | (2x) 0.18" Bullet Connector           | 500      |

For Retail Bag, add the suffix 'P' to the end of the Part No. All Part No. are sold as a unit of 1. The Case Qty is for reference only.

## PIGTAIL SPOOLS

|             |                                     |                                      |                 |    |
|-------------|-------------------------------------|--------------------------------------|-----------------|----|
| PT2022-100R | Double Female 0.18" Bullet Terminal | 9" Spacing / 90ft Length / 100 Plugs | (2x) Lead Wires | 6  |
| PT6020-100  | 2 Prong                             | 9" Spacing / 90ft Length / 100 Plugs | (2x) Lead Wires | 12 |

All Part No. are sold as a unit of 1. The Case Qty is for reference only.



# PIGTAILS - MULTI CONTACT

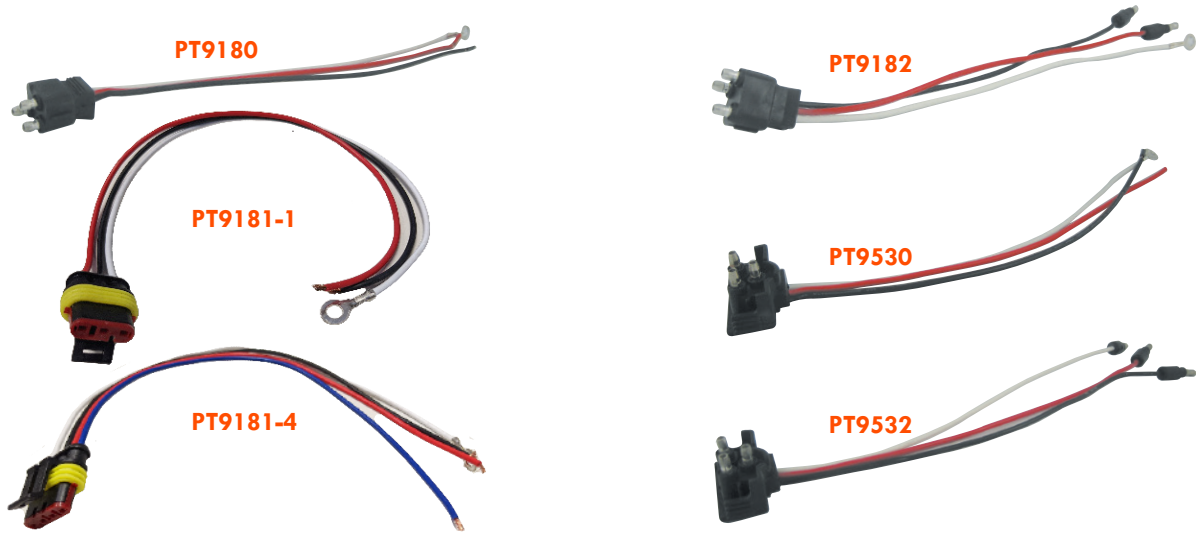

| Part No. | Connector Type          | Connector Spacing/Length | Connection   | Case Qty |
|----------|-------------------------|--------------------------|--|----------|
| PT9180   | 3 Prong                 | 9" Length                | (2x) Lead Wires<br>(1x) Ring Terminal              | 100      |
| PT9181-1 | Weatherproof Male 3-Pin | 6" Length                | (2x) Lead Wires<br>(1x) Ring Terminal              | 100      |
| PT9181-4 | Weatherproof Male 4-Pin | 6" Length                | (3x) Lead Wires<br>(1x) Ring Terminal              | 100      |
| PT9182   | 3 Prong                 | 9" Length                | (2x) 0.18" Bullet Connectors<br>(1x) Ring Terminal | 500      |
| PT9530   | 3 Prong                 | 9" Length                | (2x) Lead Wires<br>(1x) Ring Terminal              | 500      |
| PT9532   | 3 Prong                 | 9" Length                | (3x) 0.18" Bullet Connectors                       | 500      |

For Retail Bag, add the suffix 'P' to the end of the Part No. All Part No. are sold as a unit of 1. The Case Qty is for reference only.

## CONVERSION PLUGS

|          |                           |            |                           |     |
|----------|---------------------------|------------|---------------------------|-----|
| PT9181   | 3 Prong - Female          | 6" Spacing | Weatherproof Male 3-Pin   | 100 |
| PT9192   | 3 Prong - Female          | 8" Spacing | 3 Prong "Y" Split         | 80  |
| PT9581-3 | 3 Prong                   | 4" Spacing | Weatherproof Female 3-Pin | 50  |
| PT9582-3 | 3 Prong - "G" Circle Plug | 8" Spacing | PT9180 Plug               | 50  |
| PT9583-3 | 3 Prong - "G" Circle Plug | 8" Spacing | PT9530 Plug               | 50  |

For Retail Bag, add the suffix 'P' to the end of the Part No. All Part No. are sold as a unit of 1. The Case Qty is for reference only.





PT1002



PT1022



PT2504



PT9000



PT1204



PT2505



PT9050



PT1204L



PT1204T



PT9300



PT2404



PT4804T



PT9330

| Part No.  | Connector Type                                 | Connector Spacing/Length                                  | Connection  | Case Qty |
|---|--|---|---|----------|
| <b>TRAILER WIRE HARNESS</b>   |  |   |   |          |
| PT1002  | 1 Male, 1 Female 0.18" Bullet                  | 12" Length (lead wire)                                    | (2x) Lead Wires   | 500      |
| PT1022  | 1 Male, 1 Female 0.18" Bullet                  | 12" Spacing (lead wire)                                   | 1 Male, 1 Female 0.18" Bullet   | 500      |
| PT1204  | Trunk Connector                                | 12" Spacing (4-wire flat ribbon)                          | Trailer Connector   | 500      |
| PT1204L   | Trailer Connector                              | 12" Length (4-wire flat ribbon)                           | 4-wire flat ribbon  | 500      |
| PT2404  | Trunk Connector                                | 24" Spacing (4-wire flat ribbon)                          | Trailer Connector   | 200      |
| PT6004  | Trunk Connector                                | 60" Spacing (4-wire flat ribbon)                          | Trailer Connector   | 200      |
| PT2504  | Trunk Connector                                | 25ft Spacing (4-wire flat ribbon)                         | Trailer Connector   | 50       |
| PT2505  | (1x) Trunk Connector<br>(1x) Trailer Connector | 4ft Length (Trunk)<br>25ft Length w/ 18" Ground (Trailer) | 4-wire flat ribbon  | 40       |
| For Retail Bag, add the suffix 'P' to the end of the Part No. All Part No. are sold as a unit of 1. The Case Qty is for reference only. |  |   |   |          |
| <b>TRUNK WIRE HARNESS</b>   |  |   |   |          |
| PT1204T   | Trunk Connector                                | 12" Length  | 4-wire flat ribbon  | 200      |
| PT4804T   | Trunk Connector                                | 4ft Length  | 4-wire flat ribbon  | 100      |
| For Retail Bag, add the suffix 'P' to the end of the Part No. All Part No. are sold as a unit of 1. The Case Qty is for reference only. |  |   |   |          |
| <b>TRAILER MODULE HARNESS</b>   |  |   |   |          |
| PT9000  | (2x) 3 Prong                                   | -   | (1x) Male & Female 0.18" Bullet<br>(2x) Ring Terminal                           | 200      |
| PT9050  | (2x) 3 Prong                                   | -   | (2x) Male & Female 0.18" Bullet<br>(3x) Ring Terminal                           | 200      |
| PT9300  | (3x) 3 Prong                                   | -   | (1x) Male & Female 0.18" Bullet<br>(1x) Ring Terminal                           | 85       |
| PT9330  | (3x) 3 Prong                                   | -   | (1x) Male 0.18" Bullet<br>(1x) Male & Female 0.18" Bullet<br>(1x) Ring Terminal | 85       |



# WORK LAMP HARNESS & CONNECTORS



PT6812



PT1802 / PT1822



PT6800-5

PT6802-5



PT6900-5

PT6902-5



PT6610

| Part No.  | Description  | Connection         |
|---|--|--------------------|
| <b>PLUG &amp; GO HARNESS</b>                                  |  |                    |
| PT6812  | PLUG & GO Harness w/ Switch & Fuse for use with Work Lamps                       | (2x) Battery Leads |
| PT1802  | PLUG & GO Harness w/ Switch, Relay & Fuse for use with Light Bars under 10 amps  | (2x) Battery Leads |
| PT1822  | PLUG & GO Harness w/ Switch, Relay & Fuse for use with Light Bars over 10 amps   | (2x) Battery Leads |
| <b>WIRE RECEPTACLE</b>  |  |                    |
| PT6800-5  | 10" wire piece w/ male 2-Pin Deutsch receptacle                                  | (2x) Lead Wires    |
| PT6802-5  | 10" wire piece w/ female 2-Pin Deutsch receptacle                                | (2x) Lead Wires    |
| PT6900-5  | 10" wire piece w/ male Light Bar Connector receptacle                            | (2x) Lead Wires    |
| PT6902-5  | 10" wire piece w/ female Light Bar Connector receptacle                          | (2x) Lead Wires    |
| For Retail Bag, add the suffix 'P' to the end of the Part No. |  |                    |
| <b>WIRE EXTENSION</b>   |  |                    |
| PT6610  | 10ft wire extension w/ male 6-Pin Deutsch Receptacle for use with LED Head Lamps | (6x) Lead Wires    |

# SNOW PLOW PLUG & GO HARNESS

Part No.  
**PT8601**



Part No.  
**PT8602**

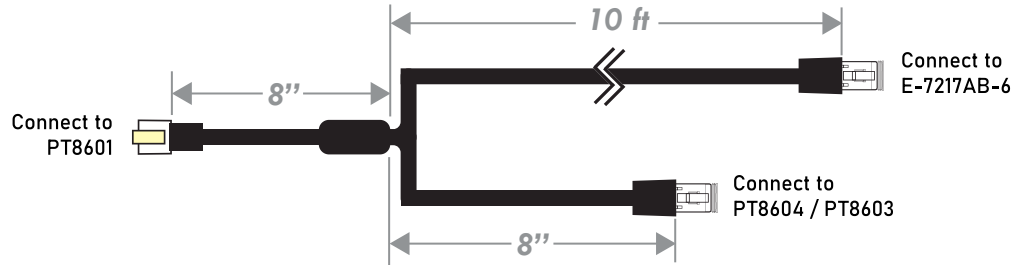

Part No.  
**PT8603-20**



| Part No.         | Description   |
|------------------|---|
| <b>PT8601</b>    | 8ft Cabin Extension to PT8602                             |
| <b>PT8602</b>    | "Y" Split to Cabin & Mid-Section to PT8603                |
| <b>PT8603-10</b> | 10ft Mid-Section Trailer Extension Wire to PT8604         |
| <b>PT8603-20</b> | 20ft Mid-Section Trailer Extension Wire to PT8604         |
| <b>PT8603-30</b> | 30ft Mid-Section Trailer Extension Wire to PT8604         |
| <b>PT8604</b>    | Vehicle Rear - Sign Board - (6x) 6-Pin Deutsch Connectors |

FOR MORE INFORMATION: Refer to page 192 for Snow Plow Sign Board Kits

Part No.  
**PT8604**

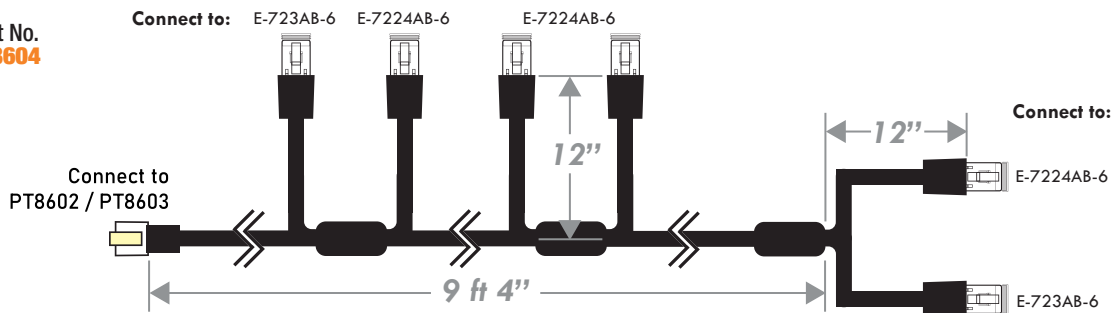

# LIGHT BAR MOUNT BRACKETS



LWM3115K



LWM3115



LWM3215K

| Part No. | Description | Tube Size | Mounting Hole |
|----------|-------------|-----------|---------------|
|----------|-------------|-----------|---------------|

**FOR HORIZONTAL / VERTICAL TUBE MOUNT**

|         |  |              |             |
|---------|--|--------------|-------------|
| LWM3115 | Bracket for mounting work lamp (hardware included) | 1.5" to 2.5" | 6mm / 0.25" |
| LWM3125 | Bracket for mounting work lamp (hardware included) | 1.5" to 2.5" | 8mm / 0.38" |

For a Set of Pair, add the suffix 'K' to the end of the Part No.

**FOR HORIZONTAL TUBE MOUNT ONLY**

|          |   |                |           |
|----------|---|----------------|-----------|
| LWM3215K | Bracket for mounting light bars (hardware included) | 1.25" to 2.25" | M6 thread |
| LWM3225K | Bracket for mounting light bars (hardware included) | 1.25" to 2.25" | M8 thread |

These only come in pairs

**FOR FLAT SURFACE MOUNT**

|          |  |   |             |
|----------|--|---|-------------|
| LWM3300K | "L" Bracket for mounting light bars (brackets only, no hardware) | - | 8mm / 0.38" |
|----------|--|---|-------------|

These only come in pairs



LWM3300K



# FUSE & SWITCH KITS

Part No. **F-S9805** Pkg: Retail Bag

- SWP4300 - Switch Panel w/ Pilot Lights
- ST100 (x3) - ON-OFF Toggle Switches
- ST108 (x1) - OFF-Momentary ON Toggle Switch
- ATM05 - 5 Amps Mini Fuse
- ATMF14C - In-Line Fuse Holder

Part No. **F-S9810** Pkg: Retail Bag

- SWP4300 - Switch Panel w/ Pilot Lights
- ST100 (x3) - ON-OFF Toggle Switches
- ST108 (x1) - OFF-Momentary ON Toggle Switch
- ATM10 - 10 Amps Mini Fuse
- ATMF14C - In-Line Fuse Holder

Part No. **F-S9820** Pkg: Retail Bag

- SWP4100 - Switch Panel (Carbon Fibre)
- ST100 (x3) - ON-OFF Toggle Switches
- ST108 (x1) - OFF-Momentary ON Toggle Switch
- ATM10 - 10 Amps Mini Fuse
- ATMF14C - In-Line Fuse Holder

Part No. **F-S936** Pkg: Retail Bag

- ST307 - OFF-ON-Momentary ON Switch
- ATM05 - 5 Amps Mini Fuse
- ATMF14C - In-Line Fuse Holder

Part No. **F-S950** Pkg: Retail Bag

- ST100 - ON-OFF Toggle Switch
- ATM05 - 5 Amps Mini Fuse
- ATMF14C - In-Line Fuse Holder

Part No. **F-S955** Pkg: Retail Bag

- ST100 - ON-OFF Toggle Switch
- ST108 - OFF-Momentary ON Toggle Switch
- ATM05 - 5 Amps Mini Fuse
- ATMF14C - In-Line Fuse Holder

Part No. **F-S957** Pkg: Retail Bag

- ST100 - ON-OFF Toggle Switch
- ST105 - ON-OFF-Momentary ON Switch
- ATM05 - 5 Amps Mini Fuse
- ATMF14C - In-Line Fuse Holder

Part No. **F-S958** Pkg: Retail Bag

- ST101 - ON-OFF-ON Switch
- ST105 - ON-OFF-Momentary ON Switch
- ATM05 - 5 Amps Mini Fuse
- ATMF14C - In-Line Fuse Holder

Part No. **F-S959** Pkg: Retail Bag

- ST100 (x2) - ON-OFF Toggle Switch
- ST108 - OFF-Momentary ON Toggle Switch
- ATM05 - 5 Amps Mini Fuse
- ATMF14C - In-Line Fuse Holder

Part No. **F-S970** Pkg: Retail Bag

- ST100 - ON-OFF Toggle Switch
- ATM075 - 7.5 Amps Mini Fuse
- ATMF14C - In-Line Fuse Holder

Part No. **F-S975** Pkg: Retail Bag

- ST100 - ON-OFF Toggle Switch
- ST108 - OFF-Momentary ON Toggle Switch
- ATM075 - 7.5 Amps Mini Fuse
- ATMF14C - In-Line Fuse Holder

Part No. **F-S976** Pkg: Retail Bag

- ST307 - OFF-ON-Momentary ON Switch
- ATM10 - 10 Amps Mini Fuse
- ATMF14C - In-Line Fuse Holder



# CAMERA SYSTEMS

## WIRELESS CAMERA SYSTEM

Wireless Distance is great up to 100m without obstacles

| Part No               | Description                                       |
|-----------------------|---|
| <b>HEATED CAMERAS</b> |   |
| <b>CM-BC0201HV</b>    | wireless camera w/ Visor                          |
| <b>MONITORS</b>       |   |
| <b>CM-BM0701</b>      | wireless monitor w/ DVR<br>**SD Card Not Included |

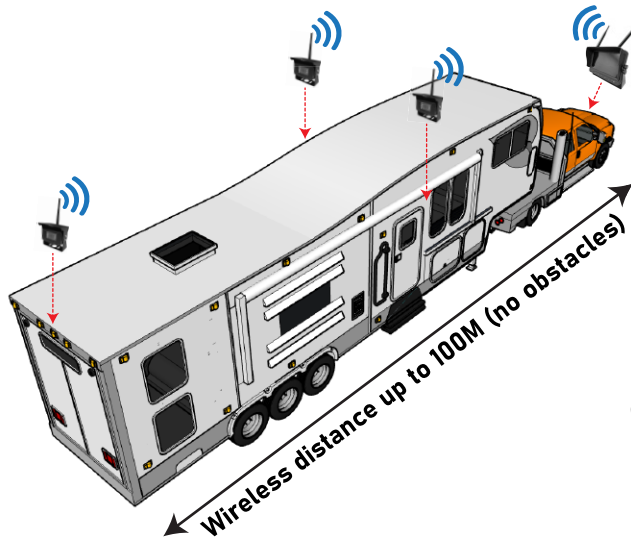

**4-Channels  
Quad-Split Display**  
Supports up to  
4 Cameras

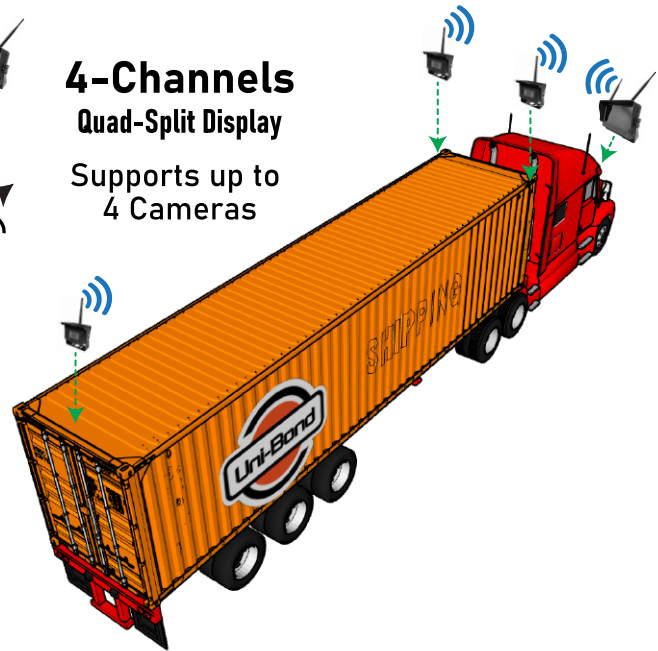

### MONITOR SPECIFICATIONS

**Voltage:** 12V / 24V DC

**Max Units:** up to 4 Cameras

**Screen Size:** 16:9

**Amp Draw:** 0.57 @ 12V

### CAMERA SPECIFICATIONS

**Voltage:** 12V - 24V DC

**Wide Angle:** 120°

**Night Vision:** 10M

**Amp Draw:** 0.15 @ 12V

**IP Rating:** IP69K

**EMC | RoHS | IP69K | CE RED**

REMOTE CONTROL & 8ft HARNESS INCLUDED  
(Supports up to 128GB)





## WIRED CAMERA SYSTEM

| Part No               | Description                                    |
|-----------------------|--|
| <b>HEATED CAMERAS</b> |  |
| <b>CM-BC0200HV</b>    | wired camera w/ Visor                          |
| <b>CM-BC0200H</b>     | wired camera                                   |
| <b>MONITORS</b>       |  |
| <b>CM-BM0700</b>      | wired monitor                                  |
| <b>CM-BM0710</b>      | wired monitor w/ DVR<br>**SD Card Not Included |
| <b>ACCESSORIES</b>    |  |
| <b>CM-BE033</b>       | 33 ft extension cable                          |
| <b>CM-BE050</b>       | 50 ft extension cable                          |
| <b>CM-BE065</b>       | 65 ft extension cable                          |

Extension Cable required for Backup Camera



### 4-Channels

Quad-Split Display

Supports up to 4 Cameras

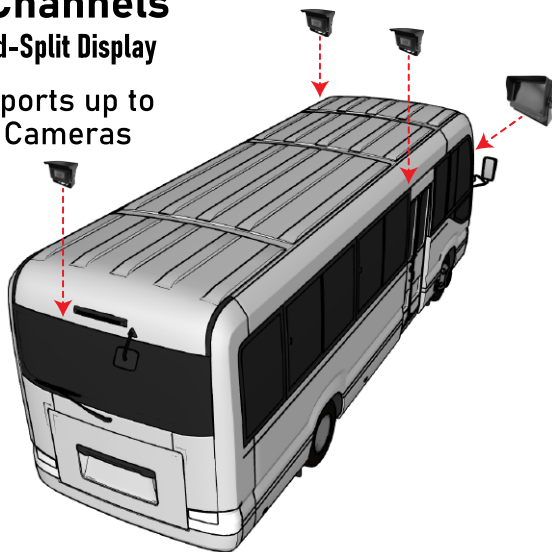

### MONITOR SPECIFICATIONS

|                     |                 |
|---------------------|-----------------|
| <b>Voltage:</b>     | 12V / 24V DC    |
| <b>Max Units:</b>   | up to 4 Cameras |
| <b>Screen Size:</b> | 16:9            |
| <b>Amp Draw:</b>    | 0.57 @ 12V      |

### CAMERA SPECIFICATIONS

|                      |            |
|----------------------|------------|
| <b>Voltage:</b>      | 12V DC     |
| <b>Wide Angle:</b>   | 120°       |
| <b>Night Vision:</b> | 10M        |
| <b>Amp Draw:</b>     | 0.11 @ 12V |
| <b>IP Rating:</b>    | IP69K      |

**EMC | RoHS | IP69K**

REMOTE CONTROL & 5ft HARNESS INCLUDED  
(Supports up to 128GB)



# SAFETY ACCESSORIES

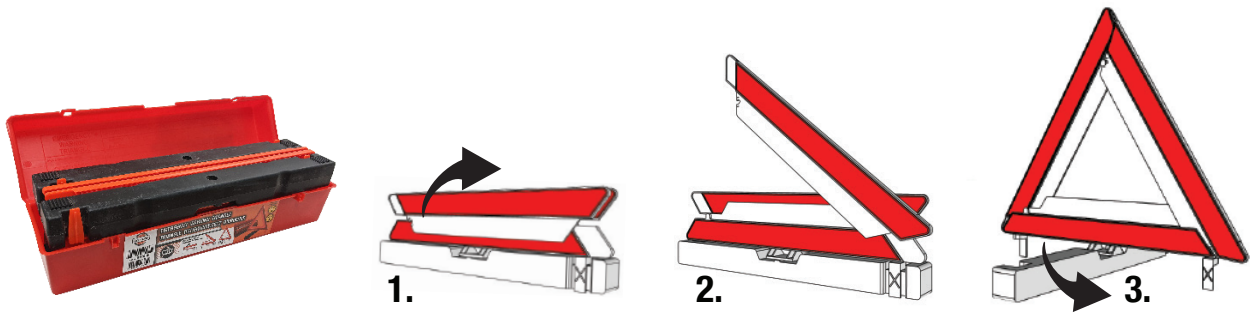

## Emergency Warning Triangle

| Part No.     | Description   |
|--------------|---|
| <b>RW03K</b> | Set of 3 Emergency Warning Triangle w/ Storage Box<br>DOT Compliant<br>Foldable Triangle with sand filled stand |

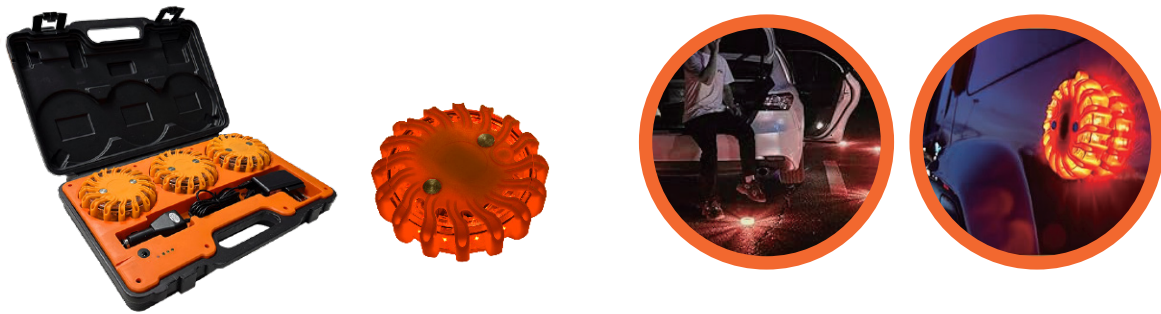

## Amber LED Warning Flare Kit

| Part No.     | Description   |
|--------------|---|
| <b>EF03K</b> | Set of 3 Amber LED Warning Flares w/ Storage Box<br>Rechargeable • Waterproof • Magnetic Mount<br>9 Flash Patterns • Visibility up to 2640 ft<br>Operating Time: 5 to 8 Hours |



**DSC220-K**



**DSC220-KC**

## Dash Camera

| Part No.         | Description   |
|------------------|---|
| <b>DSC220-K</b>  | Full HD 1080P Dash Camera w/ Cigarette Adaptor      |
| <b>DSC220-KC</b> | Full HD 1080P Dash Camera - Hard Wired w/ Converter |

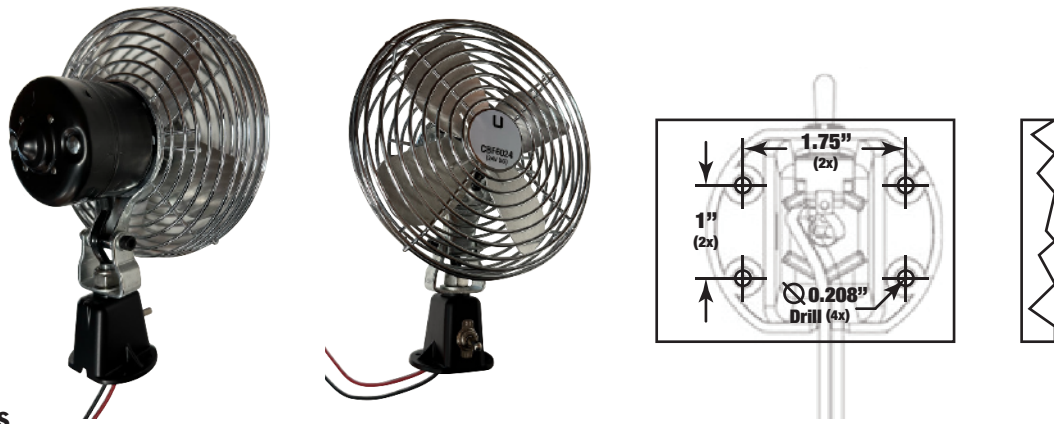

## 7" Cab Fans

| Part No.       | Speed Modes  | Fan Material          | Base Material | Fan Guard              | Voltage |
|----------------|--------------|-----------------------|---------------|------------------------|---------|
| <b>CBF6012</b> | 2 (Low - Hi) | 6.5" Blade - Aluminum | Black Steel   | Chrome Plated Aluminum | 12V DC  |
| <b>CBF6024</b> | 2 (Low - Hi) | 6.5" Blade - Aluminum | Black Steel   | Chrome Plated Aluminum | 24V DC  |

### FEATURES & BENEFITS

- Hi-Efficient DC Fans
- Extremely quiet and low noise pollution
- Reverse Voltage Protection
- Adjustable Stainless Steel Mounting Bracket

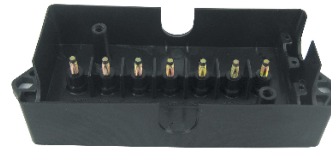

## Junction Box

| Part No.      | Type                   | Material | Dimension                   | Mounting     |
|---------------|------------------------|----------|-----------------------------|--------------|
| <b>JB0700</b> | 7-Terminal (#10 Studs) | ABS      | 8.25" L x 3.38" W x 2.25" H | 7.38" centre |

### FEATURES & BENEFITS

- Di-electric tested to 4000 volts without leakage
- Molded unit includes access hole grommets and wire retainers



## 6" PA Horn

| Part No.     | Power Input | Impedance | Frequency        | Sensitivity | Dimension                  | Material |
|--------------|-------------|-----------|------------------|-------------|----------------------------|----------|
| <b>PA608</b> | 15W         | 8 Ohms    | 400Hz to 15000Hz | 110dB       | 5.9" Diameter x 5.9" Depth | Aluminum |

### FEATURES & BENEFITS

- Durable Aluminum Housing with Rubber Bell Material

# PAR36 & PAR46 WORK LAMPS

Rubber-Like Resin



Black Enamel Steel



Rubber-Like Resin



Chrome Plated Steel



## PAR36 Series

| Part No.      | Material           | Type              |
|---------------|--------------------|-------------------|
| <b>AG5000</b> | Rubber-like Resin  | Slide-On Terminal |
| <b>AG5001</b> | Rubber-like Resin  | Fork Terminal     |
| <b>AG4050</b> | Black Enamel Steel | Fork Terminal     |

### FEATURES & BENEFITS

- Shock Absorbing characteristic and UV resistant hardware
- Fits any PAR36 Lamps
- Adjustable U-Bracket

## PAR46 Series

| Part No.        | Material            | Type            |
|-----------------|---------------------|-----------------|
| <b>AG6000</b>   | Rubber-like Resin   | Fork Terminal   |
| <b>AG6000-3</b> | Rubber-like Resin   | 3-Way Plug      |
| <b>AG6000-B</b> | Rubber-like Resin   | Bullet Terminal |
| <b>AG6055</b>   | Chrome Plated Steel | Fork Terminal   |

### FEATURES & BENEFITS

- Shock Absorbing characteristic and UV resistant hardware
- Fits any PAR46 Lamps
- Adjustable U-Bracket

Most Par 36 & Par 46 sealed beam lamps have combination slip-on/screw terminals. Made to industry standards. Available in 6, 12 & 24 Volts, standard and halogen.



| <b>SB4411</b>  | <b>SB4509</b>   | <b>SB4511</b>   | <b>SB4589</b>  | <b>SB4636-3</b>                                       |
|--|---|---|--|---|
| Slip on / Screw Terminals<br>12V 35W 3,000cp<br>Trapezoidal/Work | Slip on / Screw Terminals<br>12V 100W 110,000cp<br>Spot | Slip on / Screw Terminals<br>6V 30W 2,300cp<br>Trapezoidal/Work | Slip on / Screw Terminals<br>24V 50W 5,000cp<br>Trapezoidal/Work | Slip on / Screw Terminals<br>12V 80W 90,000cp<br>Work |
| PAR36<br>4.5" Dia.   | PAR36<br>4.5" Dia.                                      | PAR36<br>4.5" Dia.  | PAR36<br>4.5" Dia.   | PAR46<br>5.75" Dia.                                   |

## 165mm Sealed Beam Lmps

Dimension : 165mm W x 100mm H



| <b>SB7935H</b>   | <b>SB7935H-24</b>  | <b>SB7935HB</b>   | <b>SB7935H2</b>  | <b>SB7935H2-24</b>   |
|--|--|---|--|--|
| Slip on / Screw Terminals<br>12V 50W 175,000cp<br>Halogen Spot | Slip on / Screw Terminals<br>24V 75W 175,000cp<br>Halogen Spot | Slip on / Screw Terminals<br>12V 50W 165,000cp<br>Bright White Halogen Spot | Slip on / Screw Terminals<br>12V 50W 10,500cp<br>Halogen Flood | Slip on / Screw Terminals<br>24V 75W 17,400cp<br>Halogen Flood |

# WORK LAMP POP DISPLAYS

PROGRAMS & DISPLAYS  
PROGRAMMES ET AFFICHAGES



## KIT PART NO : LW3290DK

| Part No. | Beam Pattern | Opt. Penetration | Colour |
|----------|--------------|------------------|--------|
| LW3029   | Wide Flood   | 325 ft           | White  |
| LW3229   | Wide Flood   | 325 ft           | White  |

|                  |                            |
|------------------|----------------------------|
| Raw Lumens       | 3600                       |
| Effective Lumens | 2200                       |
| LED              | 4 x 6W OSRAM               |
| Voltage          | 10V - 30V                  |
| Amp Draw         | 2.5 @ 12V                  |
| Housing          | High UV Resistant Aluminum |
| Lens             | Polycarbonate              |
| CISPR25 Rating   | -                          |
| IP Rating        | IP67 & IP69K               |
| EMC              | Certified                  |
| RoHS             | Certified                  |
| Connection       | (2x) Lead Wires            |

### FEATURES & BENEFITS

- Electronic Thermal Management to control lamp temperature
- Adjustable Stainless Steel Mounting Bracket
- Reverse voltage protection

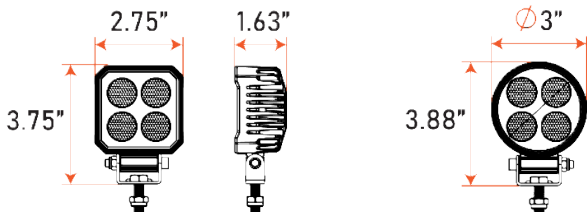

## KIT PART NO : LW2020DK

| Part No. | Beam Pattern | Opt. Penetration | Colour |
|----------|--------------|------------------|--------|
| LW2020   | Flood        | 262 ft           | White  |

|                  |                            |
|------------------|----------------------------|
| Raw Lumens       | 1040                       |
| Effective Lumens | -                          |
| LED              | 8 x 1.5W                   |
| Voltage          | 12V - 24V                  |
| Amp Draw         | 0.75 @ 12V                 |
| Housing          | High UV Resistant Aluminum |
| Lens             | Polycarbonate              |
| CISPR25 Rating   | -                          |
| IP Rating        | IP69K                      |
| EMC              | Certified                  |
| RoHS             | Certified                  |
| Connection       | (2x) Lead Wires            |

### FEATURES & BENEFITS

- Adjustable Stainless Steel Mounting Bracket
- Reverse voltage protection

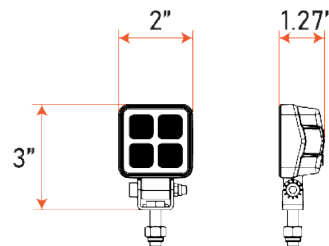



# SNOW PLOW SIGN BOARD KITS

- Fully welded aluminum frame with aluminum main board.
- Checkerboard decal attached to Dybond backer board.
- Conspicuity tape installed on lower or upper board.



## EB7510K (63" high x 88" wide)

Primarily used on larger plow trucks  
Built to current MTO specifications

**Features:**

Aluminum top air ram hood to direct air flow over the face of the sign to help keep it clean of snow dust when plowing.

Simplified 7-Pin Truck connector to hook directly into carrier truck that powers entire system.

This can be customized to each application.

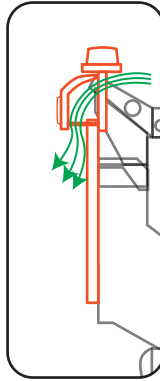

**Components:**

| Part #     | Qty | Part #      | Qty |
|------------|-----|-------------|-----|
| E-7124AB-6 | 4   | PT8604      | 1   |
| E-713AB-6  | 2   | LED4000-24R | 2   |
| E-7117AB-6 | 1   | LED2500     | 3   |

## EB7520K (63" high x 84" wide)

Primary use is mid size plow trucks  
For municipal & contractor operations

**Features:**

No Ram Hood. Built-in LED clearance lights.

Simplified 7-Pin Truck connector to hook directly into carrier truck that powers entire system.

This can be customized to each application.  
(4 pattern selections available)

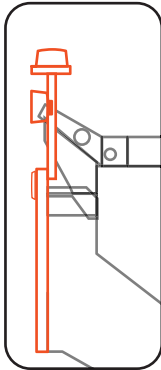

**Components:**

| Part #     | Qty | Part #      | Qty |
|------------|-----|-------------|-----|
| E-7124AB-6 | 4   | PT8604      | 1   |
| E-713AB-6  | 2   | AXL4000-24R | 2   |
| E-7117AB-6 | 1   | LED2500     | 3   |

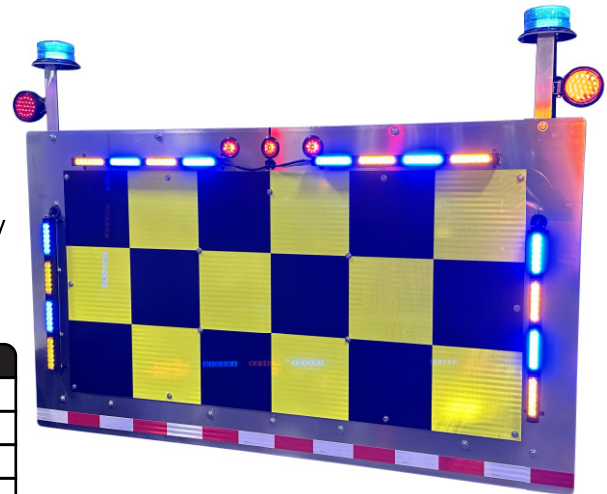

## EB7530K (63" high x 84" wide)

Primarily used as Construction Board

**Features:**

This board is designed for operator and pedestrian safety.  
More Identifiable.

**Components:**

| Part # | Qty | Part #  | Qty |
|--------|-----|---------|-----|
| E-920A | 4   | E-F6130 | 1   |
| E-920B | 4   |         |     |

Components can be customized to your liking

# SNOW PLOW SIGN BOARD KITS

Drawing is not a direct representation of installation method & should only be used as an illustration.

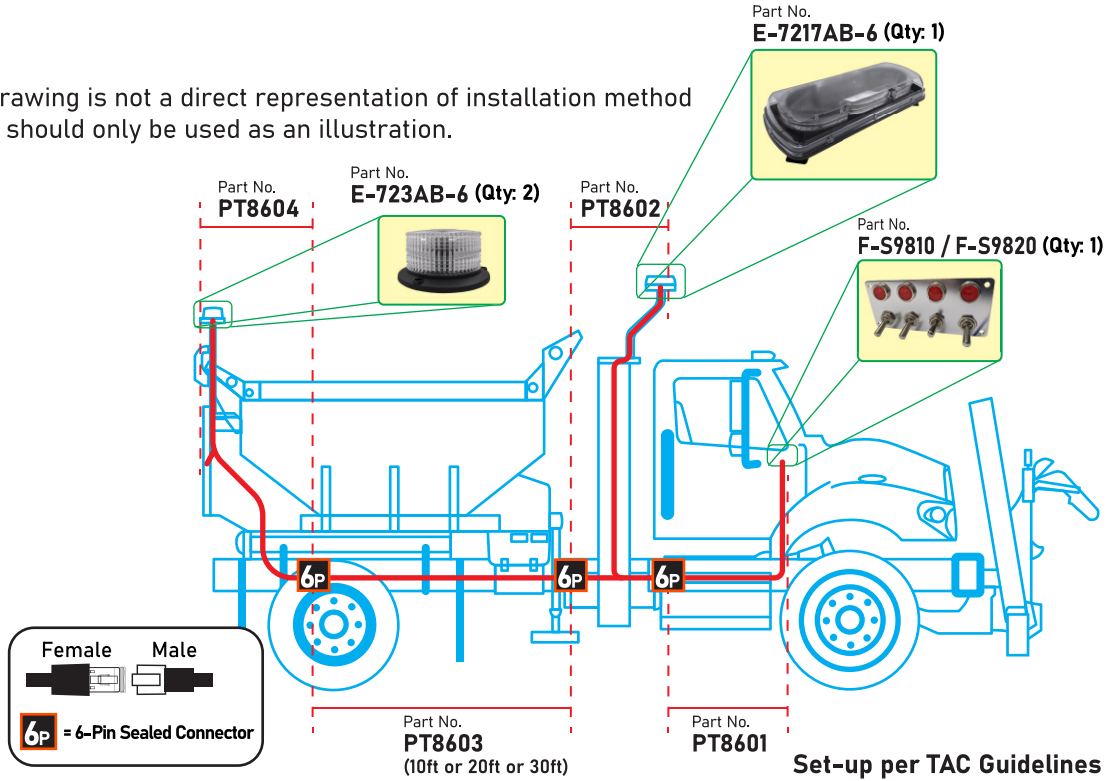

FOR MORE INFORMATION: Refer to page 185 for Plug & Go Harness Components

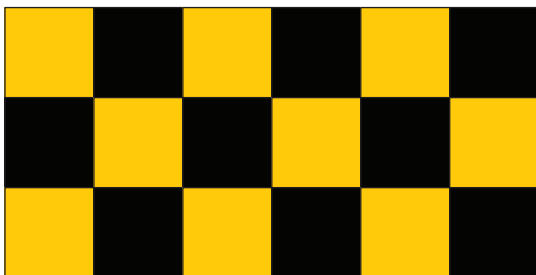
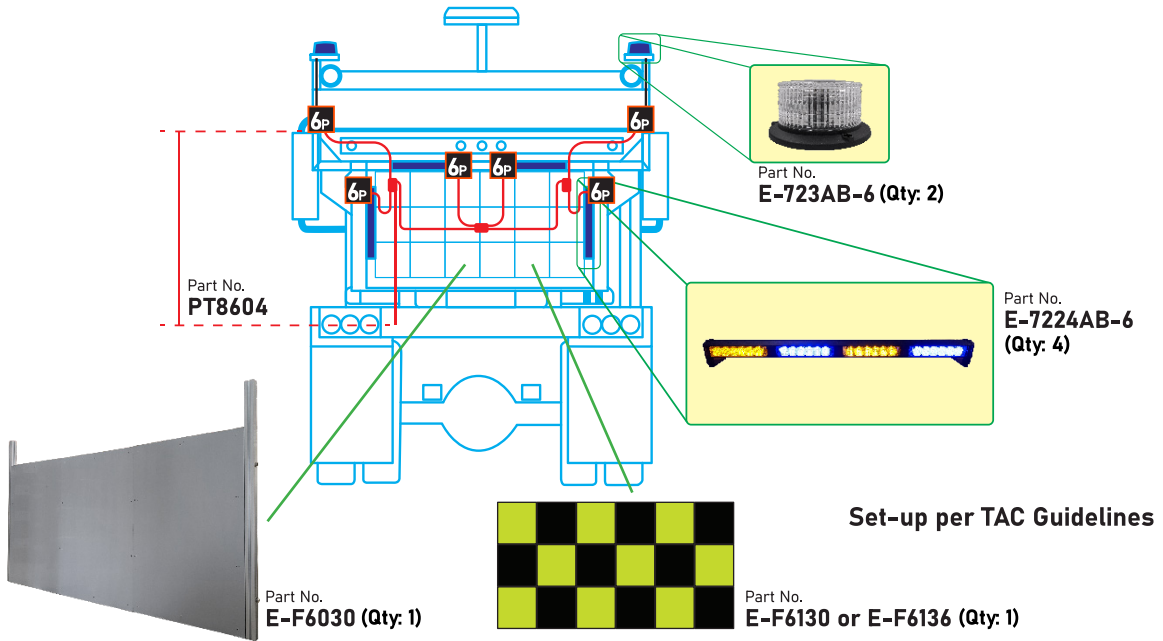

E-F6130

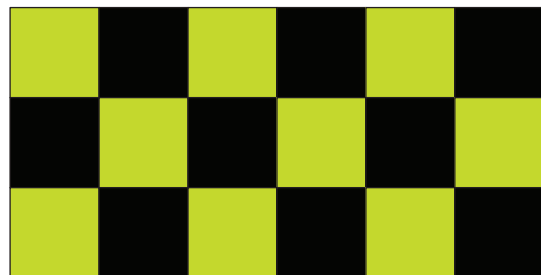

E-F6136

# DISPLAY PROGRAMS

Various styles of black steel displays available. Light displays are built with converter to plug into wall electrical outlet for power supply and can be used as a counter top display or wall mount display. Equipped with momentary ON-OFF switches. The following are sample display units.

For more information on how you can qualify for a personalized product display;  
 Please contact your sales representative or our customer service team ([services@prorenfort.ca](mailto:services@prorenfort.ca))

## Performance Work Lamp Displays



## Warning Light Displays



## Truck & Trailer Display Light Boards

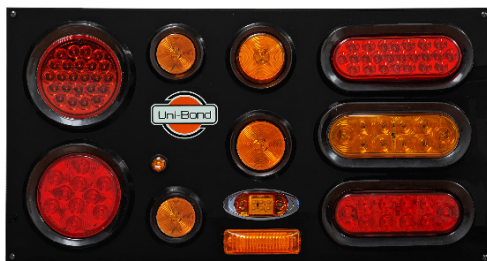

## Miniature Displays





# TRAILER LAMP LOCATION REQUIREMENTS

**IMPORTANT NOTE:** Every lamp, reflex reflector, and conspicuity treatment must be permanently attached in the location specified below and must comply with all applicable requirements prescribed for it by FMVSS/CMVSS 108. The face of any device on the front/rear and sides should be, respectively perpendicular and parallel to the vehicle's centerline, unless it is photometrically certified at installation angle. No part of the vehicle shall prevent any device from meeting its prescribed requirements unless an auxiliary device meeting all prescribed requirements is installed.

**IN CANADA:** Manufacturers and importers of vehicles must have the proper certification test records demonstrating compliance of lighting components with all prescribed requirements.

## BASIC EQUIPMENT REQUIRED ON ALL TRAILERS

| DESCRIPTION |  |                       |  | MANDATORY REQUIREMENTS |              |   |   |
|-------------|--|-----------------------|--|------------------------|--------------|---|---|
| Area        | Equipment  | SAE Lens Coding       | Functional Purpose   | Quantity               | Color        | Location  | Height mm(in.) from the ground                            |
| 1           | Tail Lamps   | (T)                   | Indicate vehicle's presence and width  | Minimum 2              | Red          | On the rear - symmetrical as far apart as practicable                 | 380-1830 (15-72)  |
|             | Stop Lamps   | (S)                   | Indicate braking   | Minimum 2              | Red          | On the rear - symmetrical as far apart as practicable                 | 380-1830 (15-72)  |
|             | Rear Turn Signal Lamps   | (I)                   | Indicate direction of turn   | Minimum 2              | Red or Amber | On the rear - symmetrical as far apart as practicable                 | 380-2110 (15-83)  |
|             | Rear Reflex Reflectors   | (A)                   | Indicate vehicle's presence and width  | Minimum 2              | Red          | On the rear - symmetrical as far apart as practicable facing rearward | 380-1530 (15-60)  |
| 2           | License Plate Lamp(s)  | (L)                   | Illuminates license plate  | Minimum 1              | White        | On the rear - above or at the sides of license plate                  | No requirement  |
| 3           | Rear Side Marker Lamps<br><small>*photometrically certified at installation angle</small>    | (P2, PC* or P3, PC2*) | Front and rear side marker lamps / side reflex reflectors indicate vehicle's presence and length | Minimum 2              | Red          | Each side at rear as far back as practicable                          | 380-1530 (15-60) no max. for veh. under 2032mm (80") wide |
|             | Rear Side Reflex Reflectors  | (A)                   |  | Minimum 2              | Red          | Each side at rear as far back as practicable facing sideward          | 380-1530 (15-60)  |
| 4           | a Front Side Marker Lamps<br><small>*photometrically certified at installation angle</small> | (P2, PC* or P3, PC2*) | Front and rear side marker lamps / side reflex reflectors indicate vehicle's presence and length | Minimum 2              | Amber        | Each side at front as far forward as practicable                      | 380 (15) minimum  |
|             | b Front Side Reflex Reflectors   | (A)                   |  | Minimum 2              | Amber        | Each side at front as far forward as practicable facing sideward      | 380-1530 (15-60)  |

## ADDITIONAL EQUIPMENT FOR TRAILERS EXCEEDING THE FOLLOWING PARAMETERS

Length 9.1m (30 ft.) or longer

| DESCRIPTION |   |                       |                                     | MANDATORY REQUIREMENTS |       |                                       |                                |
|-------------|---|-----------------------|-------------------------------------|------------------------|-------|---------------------------------------|--------------------------------|
| Area        | Equipment   | SAE Lens Coding       | Functional Purpose                  | Quantity               | Color | Location                              | Height mm(in.) from the ground |
| 5           | a Intermediate Side Marker Lamps<br><small>*photometrically certified at installation angle</small> | (P2, P3, PC* or PC2*) | Indicate presence of a long vehicle | Minimum 2              | Amber | Each side near center facing sideward | 380 (15) minimum               |
|             | b Intermediate Side Reflex Reflectors   | (A)                   | Indicate presence of a long vehicle | Minimum 2              | Amber | Each side near center facing sideward | 380-1530 (15-60)               |

Width 2032mm (80 in.) or wider

| DESCRIPTION |  |                       |  | MANDATORY REQUIREMENTS |       |  |   |
|-------------|--|-----------------------|--|------------------------|-------|--|---|
| Area        | Equipment  | SAE Lens Coding       | Functional Purpose                                       | Quantity               | Color | Location   | Height  |
| 6           | Rear Clearance Lamps<br><small>*photometrically certified at installation angle</small>  | (P2, PC* or P3, PC2*) | Show vehicle's width MAY NOT be combined with tail lamps | Minimum 2              | Red   | At widest point - symmetrical on the rear or near the rear facing rearward                     | As high as practicable may be lower only if ID lamps are at the top |
| 7           | Rear Identification (ID) Lamps   | (P2 or P3)            | Indicate presence of a wide vehicle                      | Exactly 3              | Red   | On the rear - center horizontally spaced 150mm (6 in.) to 300mm (12 in.) apart facing rearward | At the top - may be lower if door header narrower than 25mm         |
| 8           | Front Clearance Lamps<br><small>*photometrically certified at installation angle</small> | (P2, PC* or P3, PC2*) | Show vehicle's width                                     | Minimum 2              | Amber | At widest point - symmetrical on the front or near the front facing forward                    | As high as practicable  |

Width 2032mm (80 in.) or wider AND GVWR 4536 kg (10,000 lb.) or more

| DESCRIPTION |                          | MANDATORY REQUIREMENTS              |                                      |                         |   |  |   |
|-------------|--------------------------|-------------------------------------|--------------------------------------|-------------------------|---|--|---|
| Area        | Conspicuity Treatment    | DOT Coding                          | Quantity                             | Color                   | Location  | Height   | Options   |
| 9           | Rear Upper Body Markings | DOT-C<br>DOT-C2<br>DOT-C3<br>DOT-C4 | Exactly 2 pairs of 300mm long strips | White                   | On the rear upper corners facing rearward   | At the top   | Reflex reflectors may not be required if they are replaced in their required location with conspicuity treatment.<br><br>Optional in Canada: Rear lower body and side conspicuity treatment may also be solid white, solid yellow, or white and yellow. |
| 10          | Bumper Bar Marking       |                                     | Continuous                           | Red/White               | On the rear bumper bar's horizontal element full width - facing rearward  | No requirement   |   |
| 11          | Rear Lower Body Marking  |                                     | Continuous                           | Red/White (see options) | On the rear full width of the vehicle facing rearward   | As horizontal as practicable and as close as practicable to the range of 375 to 1525mm from the ground |   |
| 12          | Side Marking             |                                     | (see location)                       | Red/White (see options) | Each side - facing sideward continuous, or evenly spaced over minimum of 50% of length starts and ends as close to the front and rear of the vehicle as practicable | As horizontal as practicable and as close as practicable to the range of 375 to 1525mm from the ground |   |

**NOTE:** The edge of red conspicuity tape shall not be closer than 75 mm to the edge of any amber lamp and the edge of white conspicuity tape shall not be closer than 75 mm to the edge of any lamp

**For more information contact:** Transport Canada: Motor Vehicle Safety Enforcement Branch Attention: Compliance Engineering Fax: 613-998-4831  
National Highway Traffic Safety Administration: Office of Safety Performance Standards Attention: Richard Van Iderstine Fax: 202-366-4329

# TRAILER LAMP LOCATION REQUIREMENTS

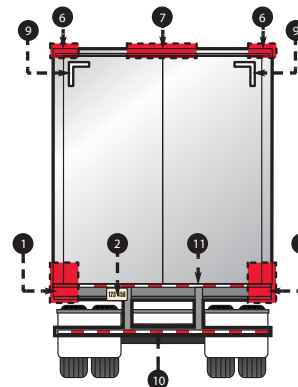
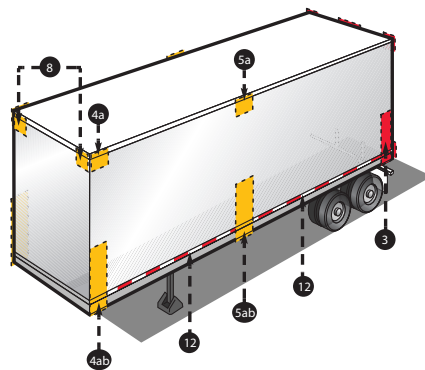
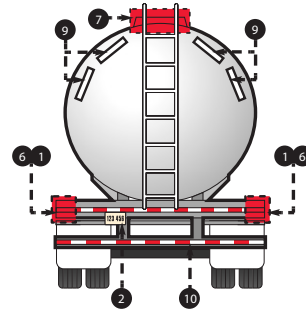
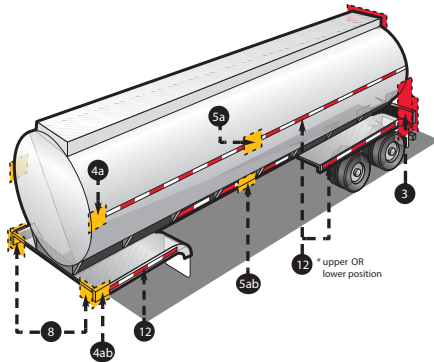
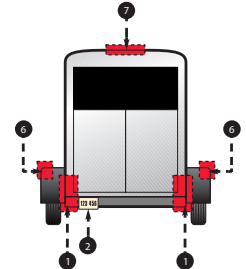
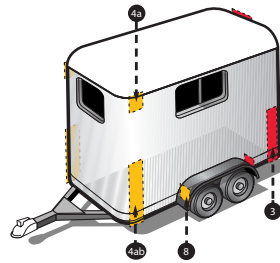
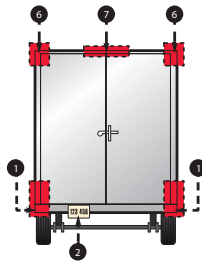
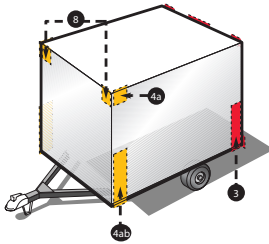
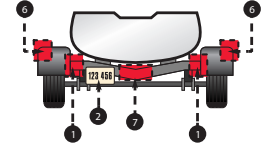
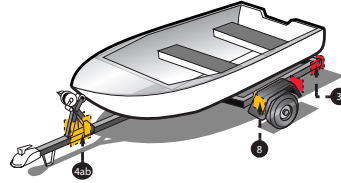
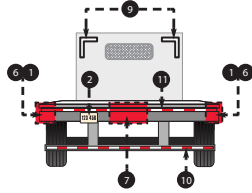
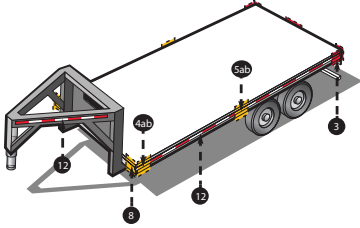
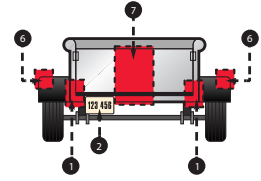
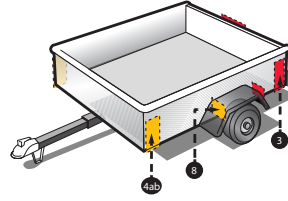
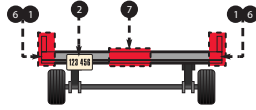
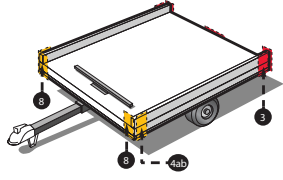



# SAE LIGHTING IDENTIFICATION CODES

| Code  | Function  |
|-------|---|
| A     | Reflex reflector  |
| A2    | Reflex reflector for use on vehicles 2032 mm or more in width   |
| A3    | Reflex reflector for conspicuity treatment (CT), for use on vehicles 2032 m or more in width  |
| A4    | Reflex reflector for CT (vehicle > 2032 mm width) - 50 mm wide (truck/trailer)  |
| A5    | Reflex reflector for CT (vehicle > 2032 mm width) - 75 mm wide (truck/trailer)  |
| A6    | Reflex reflector for CT (vehicle > 2032 mm width) - 100 mm wide (truck/trailer)   |
| A7    | Reflex reflector for CT (vehicle > 2032 mm width) - 25 mm wide (school bus)   |
| C     | Motorcycle auxiliary front lamp   |
| D     | Motorcycle and motor-driven cycle turn signal lamp  |
| DL    | Distributed lighting system (headlamp)  |
| DRL   | Daytime running lamp not optically combined with a headlamp low or high beam  |
| E     | Side turn signal lamp - vehicles 12 m or more in length   |
| E2    | Side turn signal lamp - vehicles less than 12 m in length   |
| E3    | Rear facing side turn signal lamp   |
| E4    | Side facing side turn signal lamp   |
| E5    | Side directional indicator lamp   |
| EVS1  | Siren - interior location   |
| EVS2  | Siren - exterior location   |
| EVS3  | Siren - under hood location   |
| F     | Front fog lamp  |
| F2    | Rear fog Lamp   |
| F3    | Harmonized front fog lamp   |
| G     | Truck cargo lamp  |
| H     | Sealed beam headlamp  |
| HC    | Headlamp cleaner  |
| HG    | Discharge forward lighting headlamp   |
| HH    | Sealed beam headlamp housing  |
| HI    | Integral beam headlamp  |
| HR    | Replaceable bulb headlamp (filament type)   |
| HL    | Light Emitting Diode (LED) headlamp   |
| H"x"1 | Harmonized headlamp type designation (example: HR1)   |
| I     | Rear mounted or front mounted turn signal lamp mounted 100 mm or more from the headlamp; for use on vehicles 2032 mm or less in width |
| I3    | Turn signal lamp spaced from 75 mm to less than 100 mm from headlamp  |
| I4    | Turn signal lamp spaced from 60 mm to less than 75 mm from headlamp   |
| I5    | Turn signal lamp spaced less than 60 mm from headlamp   |
| I6    | Rear mounted or front mounted turn signal lamp mounted 100 mm or more from the headlamp; for use on vehicles 2032 mm or more in width |
| I7    | Front mounted turn signal lamp mounted less than 100 mm from the headlamp, for use on vehicles 2032 mm or more in width               |

| Code  | Function  |
|-------|---|
| J1690 | Flasher   |
| K     | Front cornering lamp  |
| K2    | Rear cornering lamp   |
| L     | License plate lamp  |
| M     | Motorcycle and motor-driven cycle headlamp - motorcycle type                                |
| N     | Motorcycle and motor-driven cycle headlamp - motor driven cycle type                        |
| O     | Spot lamp   |
| P     | Parking lamp  |
| P2    | Sidemarkers lamp for use on vehicles 2032 mm or less in overall width                       |
| P3    | Clearance, sidemarkers and identification lamp for use on vehicles 2032 mm or more in width |
| PC2   | Combination clearance and sidemarkers lamp for use on vehicles 2032 mm or more in width     |
| Q     | Turn signal operating unit - Class A  |
| QB    | Turn signal operating unit - Class B  |
| QC    | Vehicular hazard warning signal operating unit  |
| QD1   | Turn signal operating unit for use on vehicles 2032 mm in width - Type 1                    |
| QD2   | Turn signal operating unit for use on vehicles 2032 mm in width - Type 2                    |
| QE1   | Hazard warning operating unit for use on vehicles 2032 mm in width - Type 1                 |
| QE2   | Hazard warning operating unit for use on vehicles 2032 mm in width - Type 2                 |
| R     | Reversing (back-up) lamp  |
| S     | Stop lamp   |
| S2    | Stop lamp for use on vehicles 2032 mm or more in width                                      |
| T     | Tail lamp (rear position lamp)  |
| T2    | Tail lamp (rear position lamp) for use on vehicles 2032 mm or more in width                 |
| U2    | High-mounted stop lamp for trucks 2032 mm or more in width                                  |
| U3    | Centre high-mounted stop lamp for passenger cars, light trucks and MPV's                    |
| V     | Town mode function  |
| W     | Weather mode function   |
| W-1   | Directional warning Device - Class 1  |
| W-2   | Directional warning Device - Class 2  |
| W-3   | Directional warning Device - Class 3  |
| W2    | Warning lamp for school buses   |
| W3-1  | Omnidirectional warning device - Class 1A   |
| W3-2  | Omnidirectional warning device - Class 2A   |
| W3-3  | Omnidirectional warning device - Class 3A   |
| WS3-1 | Selective coverage warning device - Class 1S  |
| WS3-2 | Selective coverage warning device - Class 2S  |
| WS3-3 | Selective coverage warning device - Class 3S  |
| W4    | Emergency warning device (triangular shape)   |
| W6    | School bus stop arm lamp  |
| X     | Adaptive forward lighting system  |
| Y     | Auxiliary high beam lamp  |

Quoted from SAE Manual Code J759 Revision of April 2014. Information quoted for reference only

# IP RATING

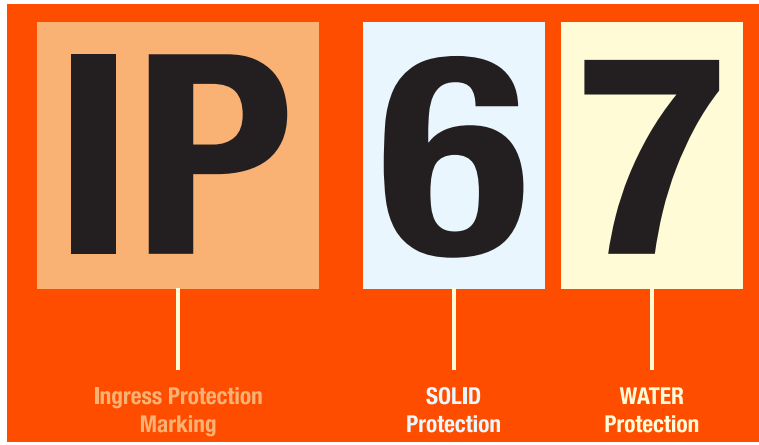

## SOLIDS

## WATER

| SOLIDS         |   | WATER   |           |
|----------------|---|---|-----------|
| <b>X</b>       | NOT TESTED  | NOT TESTED  | <b>X</b>  |
| <b>0</b>       | NO PROTECTION   | NO PROTECTION   | <b>0</b>  |
| <b>1</b>       | Protected against ingress of solid particles greater than 50mm.   | Protected against vertically falling water drops. Tested for 10mins.                                | <b>1</b>  |
| <b>2</b>       | Protected against ingress of solid particles greater than 12.5mm. | Protected against vertically falling water drops. Body tilted up to 15 degrees.                     | <b>2</b>  |
| <b>3</b>       | Protected against ingress of solid particles greater than 2.5mm.  | Protected against spraying water.   | <b>3</b>  |
| <b>4</b>       | Protected against ingress of solid particles greater than 1mm.    | Protected against splashing water.  | <b>4</b>  |
| <b>5</b>       | Dust-protected  | Protected against water jets.   | <b>5</b>  |
| <b>6</b>       | Dust-tight.   | Protected against powerful water jets.  | <b>6</b>  |
| <b>Example</b> |   | Waterproof<br>(protected against water ingress when immersed in water of up to 1m depth for 30mins) | <b>7</b>  |
| <b>IP67</b>    |   | Waterproof<br>(protected against water ingress when immersed in water of up to 3m depth)            | <b>8</b>  |
|                |   | Protected against powerful high-temperature water jets.   | <b>9K</b> |

| Part No.     | Page | Part No.  | Page    | Part No.   | Page | Part No.     | Page | Part No.  | Page | Part No.    | Page |
|--------------|------|-----------|---------|------------|------|--------------|------|-----------|------|-------------|------|
| <b>A</b>     |      | CX600SS   | 172     | E-480AM    | 84   | E-921A-K     | 90   | EW6081G   | 99   | GR2239      | 180  |
| AG4050       | 192  | CX750SS   | 172     | E-480BM    | 84   | E-921A-KM    | 90   | EW6081R   | 99   | GR2500      | 180  |
| AG5000       | 192  | CX850BE   | 172     | E-530A     | 83   | E-940A       | 93   | EW6081W   | 99   | GR2501      | 180  |
| AG5001       | 192  | CX850SS   | 172     | E-530AM    | 83   | E-940A-K     | 93   | EW6100A   | 98   | GR2502      | 180  |
| AG6000       | 192  | CX855SS   | 172     | E-540A     | 79   | E-940A-KM    | 93   | EW6100G   | 98   | GR4000      | 180  |
| AG6000-3     | 192  | CX858SS   | 173     | E-551A     | 77   | E-940B       | 93   | EW6100R   | 98   | GR4001      | 180  |
| AG6000-B     | 192  | CX859SS   | 173     | E-554B     | 77   | E-940B-K     | 93   | EW6100W   | 98   | GR4060      | 180  |
| AG6000-F     | 192  |           |         | E-556A     | 78   | E-940B-KM    | 93   | EW6101A   | 99   | <b>H</b>    |      |
| AG6000-GM    | 192  | <b>D</b>  |         | E-556AM    | 78   | E-940CA      | 93   | EW6101G   | 99   | HB1003      | 169  |
| AG6055       | 192  | DIN020    | 83      | E-557A     | 78   | E-940CA-K    | 93   | EW6101R   | 99   | HB1003-12   | 170  |
| AGH5000      | 192  | DL2020    | 105/159 | E-557AM    | 78   | E-940CA-KM   | 93   | EW6101W   | 99   | HB1156      | 169  |
| AGH6000      | 192  | DSC220-K  | 190     | E-650A     | 76   | E-940R       | 93   | EW6120A   | 99   | HB1157      | 169  |
| AXL4000-10R  | 19   | DSC220-KC | 190     | E-661A     | 76   | E-940R-K     | 93   | EW6140A   | 99   | HB1157A     | 169  |
| AXL4000-24R  | 19   |           |         | E-7117AB   | 69   | E-940R-KM    | 93   | EWL600A   | 98   | HB1309      | 169  |
| AXL4000M-10R | 19   | <b>E</b>  |         | E-7124AA   | 71   | E-950A       | 91   | EWL600AR  | 98   | HB168       | 169  |
| <b>B</b>     |      | E-0303B   | 47      | E-7124AB-1 | 71   | E-950B       | 91   | EWL600G   | 98   | HB1893      | 169  |
| BD2000       | 177  | E-2010ACM | 60      | E-713AB    | 82   | E-950CA      | 91   | EWL600R   | 98   | HB1895      | 169  |
| BD2500       | 177  | E-2102AC  | 60      | E-7211AB   | 67   | E-950CG      | 91   | EWL600W   | 98   | HB194       | 169  |
| BM1020C      | 177  | E-2102ACM | 60      | E-7211AW   | 67   | E-950CW      | 91   | EWL601A   | 99   | HB194A      | 169  |
| BM1020CB     | 177  | E-2103A   | 59      | E-7212AB   | 67   | E-950G       | 91   | EWL601G   | 99   | HB194B      | 169  |
| BM1020CG     | 177  | E-2103AM  | 59      | E-7212AW   | 67   | E-950R       | 91   | EWL601R   | 99   | HB2057      | 169  |
| BM1020R      | 177  | E-2107AC  | 59      | E-725AB    | 85   | E-986CAK     | 95   | EWL601W   | 99   | HB3156      | 169  |
| BM1020RB     | 177  | E-2107ACM | 59      | E-725AW    | 85   | EB7510K      | 194  |           |      | HB3157      | 169  |
| BM1020RG     | 177  | E-2110AC  | 58      | E-728AB    | 81   | EB7520K      | 194  | <b>F</b>  |      | HB3157A     | 169  |
| BM1021C      | 177  | E-2110ACB | 58      | E-728AW    | 81   | EB7530K      | 194  | FL2000    | 179  | HB5501-12   | 170  |
| BM1021CB     | 177  | E-2110ACM | 58      | E-7315AB   | 68   | EF03K        | 190  | FL2001    | 179  | HB5503-12   | 170  |
| BM1021CG     | 177  | E-2115AC  | 62      | E-735AB    | 85   | E-F6130      | 195  | FL2002    | 179  | HB5503-12BW | 170  |
| BM1040B      | 177  | E-2115ACM | 62      | E-735AW    | 85   | E-F6136      | 195  | FL2005    | 179  | HB5504-12   | 170  |
| BM1040BB     | 177  | E-2143A   | 61      | E-736AB    | 81   | EH-940A      | 93   | FL2238-0  | 179  | HB5507-12   | 170  |
| BM1040BC     | 177  | E-2150AM  | 61      | E-7615AB   | 68   | EH-940B      | 93   | FL2238-11 | 179  | HB5511-12   | 170  |
| BM9925       | 177  | E-2161A   | 63      | E-763AB    | 82   | EH-940CA     | 93   | FL2238-2  | 179  | HB67        | 169  |
| BU-107T      | 171  | E-2161AB  | 70      | E-765AB    | 86   | EH-940R      | 93   | FL2238-5  | 179  | HB7003-24   | 170  |
| BU-112       | 171  | E-2161ABM | 70      | E-882AC    | 75   | EHM-940A     | 93   | FL2500    | 179  | HB886       | 169  |
| BU-112J      | 171  | E-2161AC  | 63      | E-888AC    | 75   | EHM-940B     | 93   | FL2501    | 179  | HB896       | 169  |
| BU-97        | 171  | E-2161ACM | 63      | E-890A     | 74   | EHM-940CA    | 93   | FL2502    | 179  | HB9004      | 170  |
| BU-97T       | 171  | E-2161AM  | 63      | E-890B     | 74   | EHM-940R     | 93   | FL2505    | 179  | HB9005      | 170  |
| BU-97W       | 171  | E-2163A   | 63      | E-902A     | 88   | EW2040A      | 96   | FL4000    | 179  | HB9006      | 170  |
| BZ0700       | 178  | E-2163AC  | 63      | E-906AA    | 87   | EW2040B      | 96   | FL4000SS  | 179  | HB9007      | 170  |
| BZ2000       | 178  | E-2210A   | 58      | E-906AW    | 87   | EW2040G      | 96   | FL4011    | 179  | HB912       | 169  |
| BZ2000V      | 178  | E-2210AC  | 58      | E-912A     | 88   | EW2040R      | 96   | FL4012    | 179  | HBT4W       | 169  |
| BZ2238       | 178  | E-2210ACM | 58      | E-913A     | 90   | EW2040W      | 96   | FL4005    | 179  | HW1001      | 173  |
| BZ2238-5S    | 178  | E-2210AM  | 58      | E-913R     | 90   | EW2050A      | 96   | FL4060SS  | 179  | HW1002      | 173  |
| BZ2238V      | 178  | E-2215AC  | 62      | E-913W     | 90   | EW2050B      | 96   | FM4402A   | 134  | <b>J</b>    |      |
| BZ2500       | 178  | E-2215ACM | 62      | E-915AA    | 89   | EW2050G      | 96   | FM4402AA  | 134  | JB0700      | 191  |
| BZ2500V      | 178  | E-2223AC  | 64      | E-915AW    | 89   | EW2050R      | 96   | FM4402R   | 134  | <b>K</b>    |      |
| BZ4000       | 178  | E-2232AM  | 64      | E-915BB    | 89   | EW2050W      | 96   | FM4402RA  | 134  | KDL2238-24C | 107  |
| BZ4000V      | 178  | E-2232AWM | 70      | E-915BR    | 89   | EW2060A      | 96   | FML1225RA | 133  | KT2126A     | 141  |
| <b>C</b>     |      | E-230A    | 83      | E-915GG    | 89   | EW2060B      | 96   | FMR1225RA | 133  | KT2126C     | 106  |
| CBF6012      | 191  | E-230AD   | 83      | E-915SWW   | 89   | EW2060G      | 96   | FMR4402A  | 134  | KT2126R     | 141  |
| CBF6024      | 191  | E-230W    | 83      | E-916AA    | 87   | EW2060R      | 96   | FMR4402R  | 134  | KT2128A     | 141  |
| CM-BC0200H   | 189  | E-2324AC  | 65      | E-916AB    | 87   | EW2060W      | 96   | F-S936    | 187  | KT2128C     | 106  |
| CM-BC0200HV  | 189  | E-2350AW  | 69      | E-916AB    | 87   | EW2060W      | 96   | F-S950    | 187  | KT2128R     | 141  |
| CM-BC0201HV  | 188  | E-2450A   | 66      | E-916BB    | 87   | EW3040RGB    | 97   | F-S955    | 187  | KT2129A     | 141  |
| CM-BE033     | 189  | E-2457A1  | 66      | E-916GG    | 87   | EW3040RGB-2K | 97   | F-S957    | 187  | KT2129C     | 106  |
| CM-BE050     | 189  | E-250A    | 79      | E-916RR    | 87   | EW3050A      | 97   | F-S957    | 187  | KT2129R     | 141  |
| CM-BE065     | 189  | E-26409AC | 72      | E-917AA    | 89   | EW3060A      | 97   | F-S958    | 187  | KT2130A     | 141  |
| CM-BM0700    | 189  | E-2942AC  | 71      | E-917AA    | 89   | EW6030AR     | 98   | F-S959    | 187  | KT2130C     | 106  |
| CM-BM0701    | 188  | E-2971AC  | 73      | E-920A     | 92   | EW6060A      | 98   | F-S970    | 187  | KT2130R     | 141  |
| CM-BM0710    | 189  | E-2971AC  | 73      | E-920A-K   | 92   | EW6060G      | 98   | F-S975    | 187  | KT2131A     | 141  |
| CX120G       | 173  | E-2981AC  | 73      | E-920A-KM  | 92   | EW6060R      | 98   | F-S976    | 187  | KT2131C     | 106  |
| CX125G       | 173  | E-2991AC  | 73      | E-920B     | 92   | EW6060W      | 98   | F-S976    | 187  | KT2131R     | 141  |
| CX500BE      | 172  | E-333A    | 80      | E-920B-K   | 92   | EW6061A      | 99   | F-S9810   | 187  | KT2132A     | 141  |
| CX500SS      | 172  | E-333AM   | 80      | E-920B-KM  | 92   | EW6061G      | 99   | F-S9820   | 187  | KT2132C     | 106  |
| CX544SS      | 172  | E-333B    | 80      | E-920CA    | 92   | EW6061R      | 99   |           |      | KT2132R     | 141  |
| CX600BE      | 172  | E-333BM   | 80      | E-920CA-K  | 92   | EW6061W      | 99   | <b>G</b>  |      | KT2133A     | 141  |
|              |      | E-333R    | 80      | E-920CA-KM | 92   | EW6080A      | 98   | GR0700    | 180  | KT2133C     | 106  |
|              |      | E-333W    | 80      | E-920R     | 92   | EW6080G      | 98   | GR1225    | 180  |             |      |
|              |      | E-438AM   | 84      | E-920R-K   | 92   | EW6080R      | 98   | GR2000    | 180  |             |      |
|              |      | E-460AM   | 84      | E-920R-KM  | 92   | EW6080W      | 98   | GR2000-Y  | 180  |             |      |
|              |      | E-480AB   | 84      | E-921A     | 90   | EW6081A      | 99   | GR2001    | 180  |             |      |
|              |      |           |         |            |      |              |      | GR2238    | 180  |             |      |

| Part No.     | Page | Part No.      | Page | Part No.      | Page | Part No.      | Page | Part No.       | Page | Part No.       | Page |
|--------------|------|---------------|------|---------------|------|---------------|------|----------------|------|----------------|------|
| KT2133R      | 141  | KTL2001-9R    | 147  | KTL2239-6A    | 110  | KTL3201-10R   | 148  | KTL4001H-7A    | 120  | KTLM2501-4A    | 151  |
| KT2134A      | 141  | KTL2001-10A   | 148  | KTL2239-6C    | 110  | KTL3201C-10A  | 148  | KTL4001H-7C    | 120  | KTLM2501-4R    | 151  |
| KT2134C      | 106  | KTL2001-10R   | 148  | KTL2239-6R    | 110  | KTL3201C-10R  | 148  | KTL4001H-7R    | 120  | KTLM2501-6A    | 152  |
| KT2134R      | 141  | KTL2001C-10A  | 148  | KTL2239-10A   | 113  | KTL3251-4A    | 151  | KTL4001M-10R   | 121  | KTLM2501-6R    | 152  |
| KT2140A      | 142  | KTL2001C-10R  | 148  | KTL2239-10C   | 113  | KTL3251-4R    | 151  | KTL4060-24A    | 126  | KTLM2501C-6A   | 152  |
| KT2140C      | 106  | KTL2001M-1A   | 144  | KTL2239-10R   | 113  | KTL3251-6A    | 152  | KTL4060-24R    | 126  | KTLM2501C-6R   | 152  |
| KT2140R      | 142  | KTL2001M-1R   | 144  | KTL2239C-10A  | 113  | KTL3251-6R    | 152  | KTL7200-6A     | 156  | KTLM2501-12A   | 153  |
| KT2142A      | 142  | KTL2001M-10A  | 147  | KTL2239C-10R  | 113  | KTL3251C-6A   | 152  | KTL7200-6R     | 156  | KTLM2501-12R   | 153  |
| KT2142C      | 106  | KTL2001M-10R  | 147  | KTL2239S-10A  | 112  | KTL3251C-6R   | 152  | KTL7200-10A    | 156  | KTLM2501-13A   | 154  |
| KT2142R      | 142  | KTL2126-1A    | 140  | KTL2239S-10R  | 112  | KTL3251-12A   | 153  | KTL7200-10R    | 156  | KTLM2501-13R   | 154  |
| KT2143A      | 142  | KTL2126-1R    | 140  | KTL2239CS-10A | 112  | KTL3251-12R   | 153  | KTL7201-6A     | 156  | KTLM2501C-13A  | 154  |
| KT2143C      | 106  | KTL2126-3A    | 140  | KTL2239CS-10R | 112  | KTL3251-13A   | 154  | KTL7201-6R     | 156  | KTLM2501C-13R  | 154  |
| KT2143R      | 142  | KTL2126-3R    | 140  | KTL2239-13R   | 114  | KTL3251-13R   | 154  | KTL7201-10A    | 156  | KTLM2501M-13A  | 153  |
| KT3127A      | 141  | KTL2128-1A    | 140  | KTL2239-24A   | 116  | KTL3251C-13A  | 154  | KTL7201-10R    | 156  | KTLM2501M-13R  | 153  |
| KT3127C      | 106  | KTL2128-1R    | 140  | KTL2239-24C   | 116  | KTL3251C-13R  | 154  | KTL7250A       | 157  | KTLM2511-1A    | 150  |
| KT3127R      | 141  | KTL2128-3A    | 140  | KTL2239-24R   | 116  | KTL4000-1A    | 119  | KTL7250R       | 157  | KTLM2511-1R    | 150  |
| KT3200A      | 149  | KTL2128-3R    | 140  | KTL2239C-24A  | 116  | KTL4000-1C    | 119  | KTL7250-6A     | 157  | KTLM4001-1A    | 119  |
| KT3200R      | 149  | KTL2129-1A    | 140  | KTL2239C-24R  | 116  | KTL4000-1R    | 119  | KTL7250-6R     | 157  | KTLM4001-1C    | 119  |
| KT3205A      | 149  | KTL2129-1R    | 140  | KTL2239E-22AW | 117  | KTL4000-7A    | 119  | KTL7251A       | 157  | KTLM4001-1R    | 119  |
| KT3205R      | 149  | KTL2129-3A    | 140  | KTL2239G-10A  | 111  | KTL4000-7C    | 119  | KTL7251R       | 157  | KTLM4001-7A    | 119  |
| KT3215A      | 149  | KTL2129-3R    | 140  | KTL2239G-10R  | 111  | KTL4000-7R    | 119  | KTL7251-6A     | 157  | KTLM4001-7C    | 119  |
| KT3215R      | 149  | KTL2132-1A    | 140  | KTL2239G-14RW | 115  | KTL4000-10A   | 122  | KTL7251-6R     | 157  | KTLM4001-7R    | 119  |
| KT3250A      | 155  | KTL2132-1R    | 140  | KTL2239H-6A   | 111  | KTL4000-10C   | 122  | KTLM2001-1A    | 144  | KTLM4001-10A   | 122  |
| KT3250R      | 155  | KTL2132-3A    | 140  | KTL2239H-6C   | 111  | KTL4000-10R   | 122  | KTLM2001-1R    | 144  | KTLM4001-10C   | 122  |
| KT3255A      | 155  | KTL2132-3R    | 140  | KTL2239H-6R   | 111  | KTL4000C-10A  | 122  | KTLM2001-4A    | 145  | KTLM4001-10R   | 122  |
| KT3255R      | 155  | KTL2133-1A    | 140  | KTL2239M-10R  | 112  | KTL4000C-10R  | 122  | KTLM2001-4R    | 145  | KTLM4001C-10A  | 122  |
| KT3256A      | 155  | KTL2133-1R    | 140  | KTL2500-4A    | 151  | KTL4000S-10A  | 121  | KTLM2001-6A    | 146  | KTLM4001C-10R  | 122  |
| KT3256R      | 155  | KTL2133-3A    | 140  | KTL2500-4R    | 151  | KTL4000S-10R  | 121  | KTLM2001-6R    | 146  | KTLM4001S-10A  | 121  |
| KT3260A      | 117  | KTL2133-3R    | 140  | KTL2500-6A    | 152  | KTL4000CS-10A | 121  | KTLM2001C-6A   | 146  | KTLM4001S-10R  | 121  |
| KT3260C      | 107  | KTL2134-1A    | 140  | KTL2500-6R    | 152  | KTL4000CS-10R | 121  | KTLM2001C-6R   | 146  | KTLM4001CS-10A | 121  |
| KT3260R      | 117  | KTL2134-1R    | 140  | KTL2500C-6A   | 152  | KTL4000-12R   | 123  | KTLM2001-9A    | 147  | KTLM4001CS-10R | 121  |
| KT3260WC     | 117  | KTL2134-3A    | 140  | KTL2500C-6R   | 152  | KTL4000-24A   | 124  | KTLM2001-9R    | 147  | KTLM4001-12R   | 123  |
| KT3261A      | 117  | KTL2134-3R    | 140  | KTL2500-12A   | 153  | KTL4000-24C   | 124  | KTLM2001-10A   | 148  | KTLM4001-24A   | 124  |
| KT3261C      | 107  | KTL2140-4A    | 142  | KTL2500-12R   | 153  | KTL4000-24R   | 124  | KTLM2001-10R   | 148  | KTLM4001-24C   | 124  |
| KT3261R      | 117  | KTL2140-4R    | 142  | KTL2500-13A   | 154  | KTL4000C-24A  | 124  | KTLM2001C-10A  | 148  | KTLM4001-24R   | 124  |
| KT3261WC     | 117  | KTL2143-4A    | 142  | KTL2500-13R   | 154  | KTL4000C-24R  | 124  | KTLM2001C-10R  | 148  | KTLM4001C-24A  | 124  |
| KT3405A      | 125  | KTL2143-4R    | 142  | KTL2500C-13A  | 154  | KTL4000E-21AW | 125  | KTLM2001M-1A   | 144  | KTLM4001C-24R  | 124  |
| KT3405R      | 125  | KTL2238-1A    | 110  | KTL2500C-13R  | 154  | KTL4000G-10A  | 120  | KTLM2001M-1R   | 144  | KTLM4001E-21AW | 125  |
| KT3405W      | 125  | KTL2238-1C    | 110  | KTL2500M-13A  | 153  | KTL4000G-10R  | 120  | KTLM2001M-10A  | 147  | KTLM4001G-10A  | 120  |
| KT3415A      | 125  | KTL2238-1R    | 110  | KTL2500M-13R  | 153  | KTL4000G-13RW | 123  | KTLM2001M-10R  | 147  | KTLM4001G-10R  | 120  |
| KT3415R      | 125  | KTL2238-6A    | 110  | KTL2501-4A    | 151  | KTL4000H-7A   | 120  | KTLM2239-1A    | 110  | KTLM4001G-13RW | 123  |
| KT3415W      | 125  | KTL2238-6C    | 110  | KTL2501-4R    | 151  | KTL4000H-7C   | 120  | KTLM2239-1C    | 110  | KTLM4001H-7A   | 120  |
| KTL2000-1A   | 144  | KTL2238-6R    | 110  | KTL2501-6A    | 152  | KTL4000H-7R   | 120  | KTLM2239-1R    | 110  | KTLM4001H-7C   | 120  |
| KTL2000-1R   | 144  | KTL2238-10A   | 113  | KTL2501-6R    | 152  | KTL4000M-10R  | 121  | KTLM2239-6A    | 110  | KTLM4001H-7R   | 120  |
| KTL2000-4A   | 145  | KTL2238-10C   | 113  | KTL2501C-6A   | 152  | KTL4001-1A    | 119  | KTLM2239-6C    | 110  | KTLM4001M-10R  | 121  |
| KTL2000-4R   | 145  | KTL2238-10R   | 113  | KTL2501C-6R   | 152  | KTL4001-1C    | 119  | KTLM2239-6R    | 110  | KTLM4060-24A   | 126  |
| KTL2000-6A   | 146  | KTL2238C-10A  | 113  | KTL2501-12A   | 153  | KTL4001-1R    | 119  | KTLM2239-10A   | 113  | KTLM4060-24R   | 126  |
| KTL2000-6R   | 146  | KTL2238C-10R  | 113  | KTL2501-12R   | 153  | KTL4001-7A    | 119  | KTLM2239-10C   | 113  | KTLR2238-9A    | 118  |
| KTL2000C-6A  | 146  | KTL2238S-10A  | 112  | KTL2501-13A   | 154  | KTL4001-7C    | 119  | KTLM2239-10R   | 113  | KTLR2239-9A    | 118  |
| KTL2000C-6R  | 146  | KTL2238S-10R  | 112  | KTL2501-13R   | 154  | KTL4001-7R    | 119  | KTLM2239C-10A  | 113  | KTLR2248-9A    | 118  |
| KTL2000-9A   | 147  | KTL2238CS-10A | 112  | KTL2501C-13A  | 154  | KTL4001-10A   | 122  | KTLM2239C-10R  | 113  | KTLR2249-9A    | 118  |
| KTL2000-9R   | 147  | KTL2238CS-10R | 112  | KTL2501C-13R  | 154  | KTL4001-10C   | 122  | KTLM2239S-10A  | 114  | KTLRM2239-9A   | 118  |
| KTL2000-10A  | 148  | KTL2238-13R   | 114  | KTL2501M-13A  | 153  | KTL4001-10R   | 122  | KTLM2239S-10R  | 114  | KTLRM2249-9A   | 118  |
| KTL2000-10R  | 148  | KTL2238-24A   | 116  | KTL2501M-13R  | 153  | KTL4001C-10A  | 122  | KTLM2239CS-10A | 114  | KTM2001A       | 149  |
| KTL2000C-10A | 148  | KTL2238-24C   | 116  | KTL2510-1A    | 150  | KTL4001C-10R  | 122  | KTLM2239CS-10R | 114  | KTM2001R       | 149  |
| KTL2000C-10R | 148  | KTL2238-24R   | 116  | KTL2510-1R    | 150  | KTL4001S-10A  | 121  | KTLM2239-13R   | 114  | KTM2239A       | 117  |
| KTL2000M-1A  | 144  | KTL2238C-24A  | 116  | KTL2511-1A    | 150  | KTL4001S-10R  | 121  | KTLM2239-24A   | 116  | KTM2239C       | 107  |
| KTL2000M-1R  | 144  | KTL2238C-24R  | 116  | KTL2511-1R    | 150  | KTL4001CS-10A | 121  | KTLM2239-24C   | 116  | KTM2239R       | 117  |
| KTL2000M-10A | 147  | KTL2238E-22AW | 117  | KTL3201-1A    | 144  | KTL4001CS-10R | 121  | KTLM2239-24R   | 116  | KTM2239WC      | 117  |
| KTL2000M-10R | 147  | KTL2238G-10A  | 111  | KTL3201-1R    | 144  | KTL4001-12R   | 123  | KTLM2239C-24A  | 116  | KTM2501A       | 155  |
| KTL2001-1A   | 144  | KTL2238G-10R  | 111  | KTL3201-4A    | 145  | KTL4001-24A   | 124  | KTLM2239C-24R  | 116  | KTM2501R       | 155  |
| KTL2001-1R   | 144  | KTL2238G-14RW | 115  | KTL3201-4R    | 145  | KTL4001-24C   | 124  | KTLM2239E-22AW | 117  | KTM4001A       | 125  |
| KTL2001-4A   | 145  | KTL2238H-6A   | 111  | KTL3201-6A    | 146  | KTL4001-24R   | 124  | KTLM2239G-10A  | 111  | KTM4001R       | 125  |
| KTL2001-4R   | 145  | KTL2238H-6C   | 111  | KTL3201-6R    | 146  | KTL4001C-24A  | 124  | KTLM2239G-10R  | 111  | KTM4001W       | 125  |
| KTL2001-6A   | 146  | KTL2238H-6R   | 111  | KTL3201C-6A   | 146  | KTL4001C-24R  | 124  | KTLM2239G-14RW | 115  | KTMR2239A      | 117  |
| KTL2001-6R   | 146  | KTL2238M-10R  | 112  | KTL3201C-6R   | 146  | KTL4001E-21AW | 125  | KTLM2239H-6A   | 111  | KTMR2239R      | 117  |
| KTL2001C-6A  | 146  | KTL2239-1A    | 110  | KTL3201-9A    | 147  | KTL4001G-10A  | 120  | KTLM2239H-6C   | 111  | KTMR2501A      | 155  |
| KTL2001C-6R  | 146  | KTL2239-1C    | 110  | KTL3201-9R    | 147  | KTL4001G-10R  | 120  | KTLM2239H-6R   | 111  | KTMR2501R      | 155  |
| KTL2001-9A   | 147  | KTL2239-1R    | 110  | KTL3201-10A   | 148  | KTL4001G-13RW | 123  | KTLM2239M-10R  | 112  | KTMR5401R      | 125  |



| Part No.     | Page    | Part No.     | Page | Part No.      | Page | Part No.      | Page | Part No.        | Page | Part No.           | Page |
|--------------|---------|--------------|------|---------------|------|---------------|------|-----------------|------|--------------------|------|
| KTR2238A     | 118     | LED0711A     | 136  | LED2238-10R   | 113  | LED4000T-12R  | 123  | LEDF2000C-6A2   | 146  | LEDF2238CS-10R1    | 112  |
| KTR2238R     | 118     | LED0711R     | 136  | LED2238C-10A  | 113  | LED4040-1A    | 119  | LEDF2000C-6A5   | 146  | LEDF2238CS-10R2    | 112  |
| KTR2239A     | 118     | LED0720A     | 136  | LED2238C-10R  | 113  | LED4040-1C    | 119  | LEDF2000C-6R0   | 146  | LEDF2238CS-10R5    | 112  |
| KTR2239R     | 118     | LED0720B     | 136  | LED2238S-10A  | 112  | LED4040-1R    | 119  | LEDF2000C-6R1   | 146  | LEDF2238-13R0      | 114  |
| KTR3250A     | 155     | LED0720C     | 136  | LED2238S-10R  | 112  | LED4040-7A    | 119  | LEDF2000C-6R2   | 146  | LEDF2238-13R1      | 114  |
| KTR3250R     | 155     | LED0720G     | 136  | LED2238CS-10A | 112  | LED4040-7C    | 119  | LEDF2000C-6R5   | 146  | LEDF2238-13R2      | 114  |
| KTR5250A     | 155     | LED0720R     | 136  | LED2238CS-10R | 112  | LED4040-7R    | 119  | LEDF2000-9A0    | 147  | LEDF2238-13R5      | 114  |
| KTR5250R     | 155     | LED0720CA    | 136  | LED2238-13R   | 114  | LED4040-10A   | 122  | LEDF2000-9A1    | 147  | LEDF2238-24A0      | 116  |
| KTR5251A     | 155     | LED0720CR    | 136  | LED2238-24A   | 116  | LED4040-10C   | 122  | LEDF2000-9A2    | 147  | LEDF2238-24A1      | 116  |
| KTR5251R     | 155     | LED0721A     | 136  | LED2238-24C   | 116  | LED4040-10R   | 122  | LEDF2000-9A5    | 147  | LEDF2238-24A2      | 116  |
| KTR5400R     | 125     | LED0721R     | 136  | LED2238-24R   | 116  | LED4040C-10A  | 122  | LEDF2000-9R0    | 147  | LEDF2238-24A5      | 116  |
| KTR5401R     | 125     | LED0721CA    | 136  | LED2238C-24A  | 116  | LED4040C-10R  | 122  | LEDF2000-9R1    | 147  | LEDF2238-24C0      | 116  |
| KTRL2500-4A  | 151     | LED0721CR    | 136  | LED2238C-24R  | 116  | LED4040S-10A  | 121  | LEDF2000-9R2    | 147  | LEDF2238-24C1      | 116  |
| KTRL2500-4R  | 151     | LED0721L     | 160  | LED2238E-22AV | 117  | LED4040S-10R  | 121  | LEDF2000-9R5    | 147  | LEDF2238-24C2      | 116  |
| KTRL2501-4A  | 151     | LED0725-6A   | 137  | LED2238G-10A  | 111  | LED4040CS-10A | 121  | LEDF2000-10A0   | 148  | LEDF2238-24C5      | 116  |
| KTRL2501-4R  | 151     | LED0725-6R   | 137  | LED2238G-10R  | 111  | LED4040CS-10R | 121  | LEDF2000-10A1   | 148  | LEDF2238-24R0      | 116  |
| KTRL3251-4A  | 151     | LED0730A     | 136  | LED2238G-14RW | 115  | LED4040-24A   | 124  | LEDF2000-10A2   | 148  | LEDF2238-24R1      | 116  |
| KTRL3251-4R  | 151     | LED0730R     | 136  | LED2238H-6A   | 111  | LED4040-24C   | 124  | LEDF2000-10A5   | 148  | LEDF2238-24R2      | 116  |
| KTRLM2500-4A | 151     | LED0750A     | 138  | LED2238H-6C   | 111  | LED4040-24R   | 124  | LEDF2000-10R0   | 148  | LEDF2238-24R5      | 116  |
| KTRLM2500-4R | 151     | LED0750R     | 138  | LED2238H-6R   | 111  | LED4040C-24A  | 124  | LEDF2000-10R1   | 148  | LEDF2238C-24A0     | 116  |
| KTS2238-10A  | 114     | LED1025-6A   | 137  | LED2238M-10R  | 112  | LED4040C-24R  | 124  | LEDF2000-10R2   | 148  | LEDF2238C-24A1     | 116  |
| KTS2238-10C  | 114     | LED1025-6R   | 137  | LED2500-4A    | 151  | LED4040H-7A   | 120  | LEDF2000-10R5   | 148  | LEDF2238C-24A2     | 116  |
| KTS2238-10R  | 114     | LED1040-4A   | 142  | LED2500-4R    | 151  | LED4040H-7C   | 120  | LEDF2000C-10A0  | 148  | LEDF2238C-24A5     | 116  |
|              |         | LED1040-4R   | 142  | LED2500-6A    | 152  | LED4040H-7R   | 120  | LEDF2000C-10A1  | 148  | LEDF2238C-24R0     | 116  |
|              |         | LED1115-4A   | 137  | LED2500-6R    | 152  | LED4040G-10A  | 120  | LEDF2000C-10A2  | 148  | LEDF2238C-24R1     | 116  |
|              |         | LED1115-4C   | 137  | LED2500C-6A   | 152  | LED4040G-10R  | 120  | LEDF2000C-10A5  | 148  | LEDF2238C-24R2     | 116  |
| LBL1042-4R   | 158     | LED1115-4R   | 137  | LED2500C-6R   | 152  | LED4040G-13RW | 123  | LEDF2000C-10R0  | 148  | LEDF2238C-24R5     | 116  |
| LBL2000R     | 158     | LED1156-24A  | 169  | LED2500-12A   | 153  | LED4040M-10R  | 121  | LEDF2000C-10R1  | 148  | LEDF2238G-10A1     | 111  |
| LDL1140C     | 102     | LED1157-24A  | 169  | LED2500-12R   | 153  | LED4060-24A   | 126  | LEDF2000C-10R2  | 148  | LEDF2238G-10R1     | 111  |
| LDL1540C     | 102     | LED1157-24W  | 169  | LED2500-13A   | 154  | LED4060-24R   | 126  | LEDF2000C-10R5  | 148  | LEDF2238G-14RW1115 |      |
| LDL2040C     | 103     | LED1225-1A   | 140  | LED2500-13R   | 154  | LED4411       | 43   | LEDF2238-1A1    | 110  | LED2238H-6A1       | 111  |
| LDL2238-24C  | 107     | LED1225-1R   | 140  | LED2500C-13A  | 154  | LED7010A      | 128  | LEDF2238-1C1    | 110  | LED2238H-6C1       | 111  |
| LDL6000C     | 102     | LED1225-2L   | 161  | LED2500C-13R  | 154  | LED7010R      | 128  | LEDF2238-1R1    | 110  | LED2238H-6R1       | 111  |
| LDL6004C     | 104     | LED1225-3A   | 140  | LED2500M-13A  | 153  | LED7200-6A    | 156  | LEDF2238-6A1    | 110  | LEDF2500-4A0       | 151  |
| LDL6018M-12  | 103     | LED1225-3R   | 140  | LED2500M-13R  | 153  | LED7200-6R    | 156  | LEDF2238-6C1    | 110  | LEDF2500-4A1       | 151  |
| LDL6030C     | 100     | LED1315-4A   | 137  | LED2510-1A    | 150  | LED7200-10A   | 156  | LEDF2238-6R1    | 110  | LEDF2500-4A2       | 151  |
| LDL6034C     | 100     | LED1315-4C   | 137  | LED2510-1R    | 150  | LED7200-10R   | 156  | LEDF2238-10A0   | 113  | LEDF2500-4A5       | 151  |
| LDL6061C     | 101     | LED1315-4R   | 137  | LED3156A      | 169  | LED7250A      | 157  | LEDF2238-10A1   | 113  | LEDF2500-4R0       | 151  |
| LDL7550C     | 101     | LED1545-6A   | 137  | LED3156-24W   | 169  | LED7250R      | 157  | LEDF2238-10A2   | 113  | LEDF2500-4R1       | 151  |
| LDL8015C     | 101     | LED1545-6R   | 137  | LED3157-24W   | 169  | LED7250-6A    | 157  | LEDF2238-10A5   | 113  | LEDF2500-4R2       | 151  |
| LDL8030C     | 104     | LED194-5W-2  | 169  | LED3501R      | 143  | LED7250-6R    | 157  | LEDF2238-10C0   | 113  | LEDF2500-4R5       | 151  |
| LDR3030-C    | 100     | LED2000-1A   | 144  | LED4000-1A    | 119  | LED7802       | 41   | LEDF2238-10C1   | 113  | LEDF2500-6A0       | 152  |
| LDS04120RP   | 108     | LED2000-1R   | 144  | LED4000-1C    | 119  | LED7803       | 41   | LEDF2238-10C2   | 113  | LEDF2500-6A1       | 152  |
| LDS04120R-5P | 108     | LED2000-4A   | 145  | LED4000-1R    | 119  | LEDF2000-1A0  | 144  | LEDF2238-10C5   | 113  | LEDF2500-6A2       | 152  |
| LDS04206P    | 108     | LED2000-4R   | 145  | LED4000-7A    | 119  | LEDF2000-1A1  | 144  | LEDF2238-10R0   | 113  | LEDF2500-6A5       | 152  |
| LDS0470P     | 108     | LED2000-6A   | 146  | LED4000-7C    | 119  | LEDF2000-1A2  | 144  | LEDF2238-10R1   | 113  | LEDF2500-6R0       | 152  |
| LDS0612RW    | 109     | LED2000-6R   | 146  | LED4000-7R    | 119  | LEDF2000-1A5  | 144  | LEDF2238-10R2   | 113  | LEDF2500-6R1       | 152  |
| LDS0620RW    | 109     | LED2000C-6A  | 146  | LED4000-10A   | 122  | LEDF2000-1R0  | 144  | LEDF2238-10R5   | 113  | LEDF2500-6R2       | 152  |
| LDS0640RW    | 109     | LED2000C-6R  | 146  | LED4000-10C   | 122  | LEDF2000-1R1  | 144  | LEDF2238C-10A0  | 113  | LEDF2500-6R5       | 152  |
| LDS06404S    | 108     | LED2000-9A   | 147  | LED4000-10R   | 122  | LEDF2000-1R2  | 144  | LEDF2238C-10A1  | 113  | LEDF2500C-6A0      | 152  |
| LDS06127S    | 108     | LED2000-9R   | 147  | LED4000C-10A  | 122  | LEDF2000-1R5  | 144  | LEDF2238C-10A2  | 113  | LEDF2500C-6A1      | 152  |
| LDS06127S-1  | 109     | LED2000-10A  | 148  | LED4000C-10R  | 122  | LEDF2000-4A0  | 145  | LEDF2238C-10A5  | 113  | LEDF2500C-6A2      | 152  |
| LDS06207S    | 108     | LED2000-10R  | 148  | LED4000S-10A  | 121  | LEDF2000-4A1  | 145  | LEDF2238C-10R0  | 113  | LEDF2500C-6A5      | 152  |
| LDS06207S-1  | 109     | LED2000C-10A | 148  | LED4000S-10R  | 121  | LEDF2000-4A2  | 145  | LEDF2238C-10R1  | 113  | LEDF2500C-6R0      | 152  |
| LDS06407     | 108     | LED2000C-10R | 148  | LED4000CS-10A | 121  | LEDF2000-4A5  | 145  | LEDF2238C-10R2  | 113  | LEDF2500C-6R1      | 152  |
| LDS06407S    | 108     | LED2000M-1A  | 144  | LED4000CS-10R | 121  | LEDF2000-4R0  | 145  | LEDF2238C-10R5  | 113  | LEDF2500C-6R2      | 152  |
| LDS06407S-1  | 109     | LED2000M-1R  | 144  | LED4000-24A   | 124  | LEDF2000-4R1  | 145  | LEDF2238S-10A0  | 112  | LEDF2500C-6R5      | 152  |
| LDS0670P     | 108     | LED2000M-10A | 147  | LED4000-24C   | 124  | LEDF2000-4R2  | 145  | LEDF2238S-10A1  | 112  | LEDF2500-12A0      | 153  |
| LDS0675P     | 108/109 | LED2000M-10R | 147  | LED4000-24R   | 124  | LEDF2000-4R5  | 145  | LEDF2238S-10A2  | 112  | LEDF2500-12A1      | 153  |
| LED0615-4A   | 137     | LED2040-16A  | 139  | LED4000C-24A  | 124  | LEDF2000-6A0  | 146  | LEDF2238S-10A5  | 112  | LEDF2500-12A2      | 153  |
| LED0615-4C   | 137     | LED2238-1A   | 110  | LED4000C-24R  | 124  | LEDF2000-6A1  | 146  | LEDF2238S-10R0  | 112  | LEDF2500-12A5      | 153  |
| LED0615-4R   | 137     | LED2238-1C   | 110  | LED4000E-21AV | 125  | LEDF2000-6A2  | 146  | LEDF2238S-10R1  | 112  | LEDF2500-12R0      | 153  |
| LED0700A     | 136     | LED2238-1R   | 110  | LED4000G-10A  | 120  | LEDF2000-6A5  | 146  | LEDF2238S-10R2  | 112  | LEDF2500-12R1      | 153  |
| LED0700C     | 136     | LED2238-1R   | 110  | LED4000G-10R  | 120  | LEDF2000-6R0  | 146  | LEDF2238S-10R5  | 112  | LEDF2500-12R2      | 153  |
| LED0700CA    | 136     | LED2238-6A   | 110  | LED4000G-13RW | 123  | LEDF2000-6R1  | 146  | LEDF2238CS-10A0 | 112  | LEDF2500-12R5      | 153  |
| LED0700CR    | 136     | LED2238-6C   | 110  | LED4000H-7A   | 120  | LEDF2000-6R2  | 146  | LEDF2238CS-10A1 | 112  | LEDF2500-13A0      | 154  |
| LED0700G     | 136     | LED2238-6R   | 110  | LED4000H-7C   | 120  | LEDF2000-6R5  | 146  | LEDF2238CS-10A2 | 112  | LEDF2500-13A1      | 154  |
| LED0700R     | 136     | LED2238-10A  | 113  | LED4000H-7R   | 120  | LEDF2000C-6A0 | 146  | LEDF2238CS-10A5 | 112  | LEDF2500-13A2      | 154  |
| LED0700MA    | 136     | LED2238-10C  | 113  | LED4000M-10R  | 121  | LEDF2000C-6A1 | 146  | LEDF2238CS-10R0 | 112  | LEDF2500-13A5      | 154  |
| LED0700MR    | 136     |              |      |               |      |               |      |                 |      |                    |      |

**L**



| Part No.    | Page | Part No.    | Page | Part No.   | Page    | Part No.   | Page |
|-------------|------|-------------|------|------------|---------|------------|------|
| PT9581-3    | 182  | SE4040ASS   | 125  | SRF2500R-0 | 155     | TW4012R    | 168  |
| PT9582-3    | 182  | SE4040RSS   | 125  | SRF2500R-1 | 155     | TW4100-1R  | 167  |
| PT9583-3    | 182  | SE4040WSS   | 125  | SRF2500R-2 | 155     | TW4110-1R  | 167  |
| <b>R</b>    |      | SEF2000A-0  | 149  | SRF2500R-5 | 155     | TW4111-1R  | 167  |
| RF1301A     | 176  | SEF2000A-1  | 149  | SRF4000R-0 | 125     | TW4112-1R  | 167  |
| RF1301R     | 176  | SEF2000A-2  | 149  | SRF4000R-1 | 125     | TW4100-10R | 167  |
| RF1501A     | 176  | SEF2000A-5  | 149  | SRF4000R-2 | 125     | TW4110-10R | 167  |
| RF1501R     | 176  | SEF2000R-0  | 149  | SRF4000R-5 | 125     | TW4111-10R | 167  |
| RF2001A     | 176  | SEF2000R-1  | 149  | SW010P     | 108/109 | TW4112-10R | 167  |
| RF2001R     | 176  | SEF2000R-2  | 149  | <b>T</b>   |         | TW4100-24R | 167  |
| RF2012A     | 176  | SEF2000R-5  | 149  | TG360ARW   | 128     | TW4110-24R | 167  |
| RF2012R     | 176  | SEF2238A-0  | 117  | TG360RW    | 128     | TW4111-24R | 167  |
| RF2421A     | 176  | SEF2238A-1  | 117  | TL4400     | 130     | TW4112-24R | 167  |
| RF2421R     | 176  | SEF2238A-2  | 117  | TL4400K    | 130     | TW4502R    | 168  |
| RF3001A     | 176  | SEF2238A-5  | 117  | TL4400L    | 130     | <b>W</b>   |      |
| RF3001R     | 176  | SEF2238C-0  | 107  | TL4401     | 130     | WC3630     | 173  |
| RF3012A     | 176  | SEF2238C-1  | 107  | TL4401L    | 130     | WC3650     | 173  |
| RF3012R     | 176  | SEF2238C-2  | 107  | TL5441     | 129     | WC3670     | 173  |
| RF3022A     | 176  | SEF2238C-5  | 107  | TL5441L    | 129     | WC3672     | 173  |
| RF3022R     | 176  | SEF2238R-0  | 117  | TL5450K    | 131     | WC6160SS   | 174  |
| RT1001RW-10 | 175  | SEF2238R-1  | 117  | TL5450LH   | 131     | WC6165SS   | 174  |
| RT1001RW-5  | 175  | SEF2238R-2  | 117  | TL5450RH   | 131     | WC7160SS   | 174  |
| RT10150RW   | 175  | SEF2238R-5  | 117  | TL6400     | 126     | WC7615HP   | 174  |
| RT2001A-5   | 175  | SEF2238WC-0 | 117  | TL7000     | 132     | WC7165SS   | 174  |
| RT2001RW-10 | 175  | SEF2238WC-1 | 117  | TL7000L    | 132     | WC7169SS   | 174  |
| RT2001RW-5  | 175  | SEF2238WC-2 | 117  | TM3000U    | 166     | WCG6160    | 174  |
| RT20150A    | 175  | SEF2238WC-5 | 117  | TM3050U    | 166     | WCG7160    | 174  |
| RT2050A     | 175  | SEF2500A-0  | 155  | TM3053U    | 166     | WCR1000    | 174  |
| RT20150RW   | 175  | SEF2500A-1  | 155  | TM8000L    | 162     | WCR1000-1  | 174  |
| RT2050RW    | 175  | SEF2500A-2  | 155  | TM8000R    | 162     |            |      |
| RT2001W-10  | 175  | SEF2500A-5  | 155  | TM8000U    | 162     |            |      |
| RT2001W-5   | 175  | SEF2500R-0  | 155  | TM8050L    | 165     |            |      |
| RT20150W    | 175  | SEF2500R-1  | 155  | TM8050R    | 165     |            |      |
| RT2050W     | 175  | SEF2500R-2  | 155  | TM8050U    | 165     |            |      |
| RW03K       | 190  | SEF2500R-5  | 155  | TM8060R    | 165     |            |      |
| <b>S</b>    |      | SEF4000A-0  | 125  | TM8060U    | 165     |            |      |
| SB4411      | 192  | SEF4000A-1  | 125  | TM8070L    | 165     |            |      |
| SB4509      | 192  | SEF4000A-2  | 125  | TM8070U    | 165     |            |      |
| SB4511      | 192  | SEF4000A-5  | 125  | TM9001L    | 162     |            |      |
| SB4589      | 192  | SEF4000R-0  | 125  | TM9001R    | 162     |            |      |
| SB4636-3    | 192  | SEF4000R-1  | 125  | TM9001U    | 162     |            |      |
| SB7935H     | 192  | SEF4000R-2  | 125  | TM9010L    | 163     |            |      |
| SB7935H2    | 192  | SEF4000R-5  | 125  | TM9010R    | 163     |            |      |
| SB7935H2-24 | 192  | SEF4000W-0  | 125  | TM9010U    | 163     |            |      |
| SB7935H-24  | 192  | SEF4000W-1  | 125  | TM9024L    | 164     |            |      |
| SB7935HB    | 192  | SEF4000W-2  | 125  | TM9024R    | 164     |            |      |
| SE1040A     | 142  | SEF4000W-5  | 125  | TM9024U    | 164     |            |      |
| SE1040ABS   | 142  | SG800       | 150  | TM9301U    | 166     |            |      |
| SE1040C     | 106  | SM301AL     | 172  | TM9310U    | 166     |            |      |
| SE1040R     | 142  | SM375BP     | 172  | TM9324U    | 166     |            |      |
| SE1225A     | 141  | SM554AL     | 172  | TM9401U    | 166     |            |      |
| SE1225C     | 106  | SR2238A     | 118  | TM9410U    | 166     |            |      |
| SE1225L     | 161  | SR2238R     | 118  | TM9424U    | 166     |            |      |
| SE1225R     | 141  | SR2500A     | 155  | TM9601U    | 162     |            |      |
| SE2000A     | 149  | SR2500R     | 155  | TM9610U    | 163     |            |      |
| SE2000ABS   | 149  | SR4000R     | 125  | TM9624U    | 164     |            |      |
| SE2000R     | 149  | SR4040RSS   | 125  | TM9701U    | 162     |            |      |
| SE2238A     | 117  | SFR2238A-0  | 118  | TM9710U    | 163     |            |      |
| SE2238C     | 107  | SFR2238A-1  | 118  | TM9724U    | 164     |            |      |
| SE2238R     | 117  | SFR2238A-2  | 118  | TM9801L    | 162     |            |      |
| SE2238WC    | 117  | SFR2238A-5  | 118  | TM9801R    | 162     |            |      |
| SE2500A     | 155  | SFR2238R-0  | 118  | TM9810L    | 163     |            |      |
| SE2500ABS   | 155  | SFR2238R-1  | 118  | TM9810R    | 163     |            |      |
| SE2500R     | 155  | SFR2238R-2  | 118  | TM9824L    | 164     |            |      |
| SE4000A     | 125  | SFR2238R-5  | 118  | TM9824R    | 164     |            |      |
| SE4000R     | 125  | SFR2500A-0  | 155  | TW4000R    | 168     |            |      |
| SE4000W     | 125  | SFR2500A-1  | 155  | TW4010R    | 168     |            |      |
|             |      | SFR2500A-2  | 155  | TW4011R    | 168     |            |      |
|             |      | SFR2500A-5  | 155  |            |         |            |      |